

**SPECIAL SECTION:
ELECTRONICS IN PHOTOGRAPHY**

\$1.50 AUG. 1983
U.K. 85p

DGS

Radio- Electronics®

COMPUTERS - VIDEO - STEREO - TECHNOLOGY - SERVICE

Build a
TIMEX/SINCLAIR EXPANSION
to enhance the operating system

Special Section
ELECTRONICS IN PHOTOGRAPHY

- ★ Autofocus and Auto-Exposure Electronics
- ★ The All-Electronic Mavica
- ★ The New Disc Cameras
- ★ Photographic Accessories
- ★ Electronics in the Darkroom

The life and times of
NIKOLA TESLA
the father of AC

Build a
TEMP GAUGE
for your car

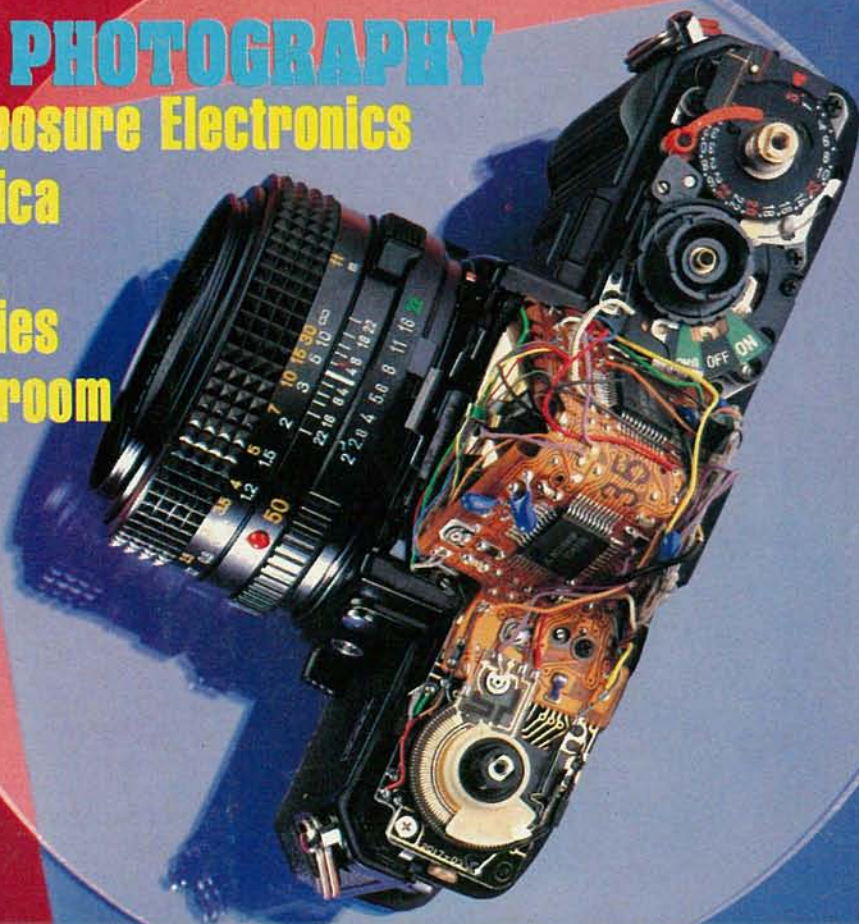

Attention retailers: See page 99
for special display allowance plan.

PLUS:

- ★ Videogames ★ Hobby Corner
- ★ Drawing Board ★ Service Clinic
- ★ New Idea ★ State-Of-Solid-State





Xcelite.[®]

The name to connect with.



Handtools for electronics?
Get Xcelite from Cooper.

The Xcelite range is truly phenomenal.

For example, there are 38 patterns
of pliers alone — including 13 genuine “miniatures.”
Xcelite handtools are made to exacting tolerances.

They're rugged and longlasting.

Most important of all, they're designed specifically to do the
jobs you do. Individual tools and kits are at your distributors now.

Go and see them!

The Cooper Group PO Box 728 Apex NC 27502 USA Tel (919) 362-7510 Telex 579497

BOKER[®] CRESCENT[®] LUFKIN[®] NICHOLSON[®] PLUMB[®] WELLER[®] WISS[®] XCELITE[®]

CooperTools

CIRCLE 69 ON FREE INFORMATION CARD

Double Your Troubleshooting and Testing Productivity . . . Or Your Money Back!

Six-digit readout: Automatically tracks every CRT test. We call it digital autotracking. It's patent pending.

Bright dual-trace CRT: 60 MHz (-3 dB); 100 MHz (-12 dB).

Delta PPV, Time, Freq: Measure any part of a waveform for PPV, time or frequency using Delta measurements. Just dial in the waveform section you want to measure and push.

Simplify Freq ratio tests: Automatically compare input/output ratio of multiply/divide stages from 1:1 to 1:999,999 with the push of a button.



Autotracking DCV, PPV, Freq: Measure DCV to .5%; PPV to 2%; freq. to .001%. Just push a button for either Channel A or B.

One probe input: One probe input per channel for all measurements - digital and scope - with 5 mV to 2000 V measuring range. (2 lo-cap probes provided.)

Super sync: ECL provides rock-solid sync trigger circuits with only 4 controls; includes TV sync separators for video work.

U. S. Patent Pending
Financing Available

The first scope with push button digital readout. If you use general purpose oscilloscopes for troubleshooting or testing, we can double your present productivity with the SC61 Waveform Analyzer, the first instrument to turn every conventional scope measurement into an automatic digital readout.

No more graticule counting. Connect only one probe to view any waveform to 100 MHz. Then, just push a button to read DCV, PPV, frequency and time — automatically!

There are no graticules to count or calculations to make, which speeds every measurement.

The digital readout is from 10 to 10,000 times more accurate as well.

Plus you have everything you want to know about a test point, at the push of a button, which speeds troubleshooting tremendously.

A special Delta function even lets you intensify parts of a waveform and digitally measure the PPV, time or frequency for just that waveform section.

And it's neat. No more tangled leads, piles of probes or dangling cords. The SC61 is an entire test station in one unit.

The one and only. There are other scopes with digital readout, but none of them completely automate every conventional scope measurement so you can automatically analyze any waveform without counting one single graticule. Totally automatic waveform analyzing at the push of a button. It will make all the difference in your productivity.

Double your productivity. When we say the SC61 will double your productivity, we're being conservative. We've seen cases of

three, four, even ten time increases in productivity with this first-of-its-kind, automated oscilloscope. Every situation is different, however, so try the SC61 and judge for yourself. Here's our offer.

Money back guarantee. If the SC61 does not at least double your productivity during the first thirty days, you may return it for a full refund, including freight both ways.

Call today. Get the entire SC61 Waveform Analyzer story. Call toll-free today, and ask for our eight page color brochure. It could be the most productive call you make this year!

**Phone Toll-Free
1-800-843-3338**

Alaska, Hawaii, Canada and South Dakota call collect (605) 339-0100

SENCORE
3200 Sencore Drive, Sioux Falls, SD 57107

CIRCLE 70 ON FREE INFORMATION CARD
CIRCLE 71 FOR DEMONSTRATION

wabash[®] diskettes \$1.29 each!

for
as
low
as

Now get Wabash Quality at a CE Price

For over 17 years, Wabash has been making high quality and dependable computer products. Wabash diskettes are made to provide error-free performance on your computer system because every diskette has been totally and hypercritically tested. Since you can now buy Wabash computer products directly from CE, the world's largest distributor of magnetic media, you can now get maximum savings on every order. You can even order toll-free.

New Wabash Six Year Warranty

The quality of Wabash diskettes is stressed throughout the entire manufacturing process. After coating, all Wabash diskettes go through a unique burnishing process that gives each diskette a mirror-smooth appearance. Wabash then carefully applies a lubricant that is specially formulated to increase diskette life. Then, to keep out foreign particles, a unique heat seal bonds the jacket and liner together to help prevent contamination. After 100% hypercritical testing and certification, Wabash then packages each diskette, (except bulk pack) in a super strong and tear resistant Tyvek[®] envelope. The final Wabash product is then shrink-wrapped to insure cleanliness and reduce contamination during shipment. Wabash diskettes are so very reliable that Wabash now offers a six year warranty in case of defects in materials or workmanship on all diskettes purchased directly from Communications Electronics.

New...Wabash Diskette Duplication Services

Communications Electronics has teamed up with Wabash to provide a single-source solution for the diskette duplication requirements of software developers, OEM's and distributors. All service is in-house, to give you fast, dependable service. In most cases, delivery can be completed in five days. Whether you require 100, 1,000, or 10,000 copies per week, call CE first for a no obligation price quote. For additional information, please write us on your letterhead with your requirements.

SAVE ON WABASH DISKETTES

Product Description	Part #	CE quant. 100 price per disk (\$)
8" SSSD IBM Compatible (128 B/S, 26 Sectors)	F111	1.89
8" SSSD Shugart Compatible, 32 Hard Sector	F31A	1.89
8" SSDD IBM Compatible (128 B/S, 26 Sectors)	F131	2.39
8" DSDD Soft Sector (Unformatted)	F14A	2.99
8" DSDD Soft Sector (256 B/S, 26 Sectors)	F144	2.99
8" DSDD Soft Sector (512 B/S, 15 Sectors)	F145	2.99
8" DSDD Soft Sector (1024 B/S, 8 Sectors)	F147	2.99
5 1/4" SSSD Soft Sector w/Hub Ring	M11A	1.49
5 1/4" Same as above, but bulk pack w/o envelope	M11AB	1.29
5 1/4" SSSD 10 Hard Sector w/Hub Ring	M41A	1.49
5 1/4" SSSD 16 Hard Sector w/Hub Ring	M51A	1.49
5 1/4" SSDD Soft Sector w/Hub Ring	M13A	1.79
5 1/4" Same as above, but bulk pack w/o envelope	M13AB	1.59
5 1/4" SSDD 10 Hard Sector w/Hub Ring	M43A	1.79
5 1/4" SSDD 16 Hard Sector w/Hub Ring	M53A	1.79
5 1/4" DSDD Soft Sector w/Hub Ring	M14A	2.69
5 1/4" Same as above, but bulk pack w/o envelope	M14AB	2.49
5 1/4" DSDD 10 Hard Sector w/Hub Ring	M44A	2.69
5 1/4" DSDD 16 Hard Sector w/Hub Ring	M54A	2.69
5 1/4" SSQD Soft Sector w/Hub Ring (96 TPI)	M15A	2.59
5 1/4" DSQD Soft Sector w/Hub Ring (96 TPI)	M16A	3.69
5 1/4" Tyvek Diskette Envelopes - Price per 100 Pack	TE5	12.00

SSSD = Single Sided Single Density; SSDD = Single Sided Double Density;
DSDD = Double Sided Double Density; SSQD = Single Sided Quad Density;
DSQD = Double Sided Quad Density; TPI = Tracks per inch.

Quantity Discounts Available
Wabash diskettes are packed 10 disks to a carton and 10 cartons to a case. The economy bulk pack is packaged 100 disks to a case without envelopes or labels. Please order only in increments of 100 units for quantity 100 pricing. With the exception of bulk pack, we are also willing to accommodate your smaller orders. Quantities less than 100 units are available in increments of 10 units at a 20% surcharge above our 100 unit price. **Quantity discounts** are also available.



Order 500 or more disks at the same time and deduct 1%; 1,000 or more saves you 2%; 2,000 or more saves 3%; 5,000 or more saves 4%; 10,000 or more saves 5%; 25,000 or more saves 6%; 50,000 or more saves 7%; 100,000 or more saves 8%; 500,000 or more saves 9% and 1,000,000 or more disks earns you a 10% discount off our super low quantity 100 price. Almost all Wabash diskettes are immediately available from CE. Our efficient warehouse facilities are equipped to help us get you the quality product you need, when you need it. If you need further assistance to find the flexible disk that's right for you, call the Wabash compatibility hotline. Dial toll-free 800-323-9868 and ask for your compatibility representative. In Illinois or outside the U.S. dial 312-593-6363 between 9 AM to 4 PM Central time.

Buy Wabash Diskettes with Confidence

To get the fastest delivery from CE of your Wabash computer products, we recommend you phone your order directly to our Computer Products Division and charge it to your credit card. Be sure to calculate your price using the CE prices in this ad. Written purchase orders are accepted from approved government agencies and most well rated firms at a 30% surcharge for net 30 billing. For maximum savings, your order should be prepaid. All sales are subject to availability, acceptance and verification. All sales are final. All prices are in U.S. dollars. Prices, terms and specifications are subject to change without notice. Out of stock items will be placed on backorder automatically unless CE is instructed differently. Minimum *prepaid* order is \$50.00. Minimum *purchase order* \$200.00. All shipments are F.O.B. Ann Arbor, Michigan U.S.A. No COD's please. Non-certified and foreign checks require bank clearance.

For **shipping charges** add \$8.00 per case or partial case of 100 8-inch flexible disks or \$6.00 per case or partial case of 100 5 1/4-inch mini-diskettes for U.P.S. ground shipping and handling in the continental U.S.A.

Mail orders to: Communications Electronics, Box 1002, Ann Arbor, Michigan 48106 U.S.A. If you have a Visa or Master Card, you may call and place a credit card order. Order toll-free in the U.S. Dial 800-521-4414. In Canada, order toll-free by calling 800-265-4828. If you are outside the U.S. or in Michigan dial 313-994-4444. Telex anytime 810-223-2422. Order your Wabash diskettes today.

Copyright ©1983 Communications Electronics™

Ad #U12483



Order Toll-Free!
800-521-4414

In Michigan 313-994-4444

wabash
error-free
diskettes

**COMMUNICATIONS
ELECTRONICS™**

Computer Products Division

818 Phoenix □ Box 1002 □ Ann Arbor, Michigan 48106 U.S.A.
Order TOLL-FREE 800-521-4414 or outside U.S.A. 313-994-4444

SPECIAL SECTION

- 57 ELECTRONICS IN PHOTOGRAPHY, Marc Stern
- 59 The All-Electronic Mavica
- 63 The New Disc Cameras
- 67 Auto-Focus and Auto-Exposure Systems
- 75 Accessories: Smart Strobes and Meters
- 79 Electronics in the Darkroom

BUILD THIS

- 83 TIMEX/SINCLAIR MEMORY EXPANSION
Part 2. Finishing up construction, and a number of useful machine-language utilities you can store in your add-on RAM. Paul W.W. Hunter
- 92 DIGITAL TEMPERATURE GAUGE
This valuable accessory for your car can also be used anywhere you need a remote temperature display. Fred L. Young, Sr. and Fred L. Young, Jr.

TECHNOLOGY

- 4 VIDEO ELECTRONICS
Tomorrow's news and technology in this quickly changing industry. David Lachenbruch
- 12 SATELLITE/TELETEXT NEWS
The latest happenings in communications technology. Gary H. Arlen
- 14 VIDEOGAMES
A game-development system for the Atari. Danny Goodman
- 51 NIKOLA TESLA
Some insights into the life of this unsung inventor. E.J. Quinby
- 104 STATE OF SOLID STATE
Two precision voltage-references. Robert F. Scott

CIRCUITS AND COMPONENTS

- 96 NEW IDEAS
Electronic insect-repeller
- 98 DRAWING BOARD
The final word about power supplies. Robert Grossblatt
- 100 HOBBY CORNER
For the birds. Earl "Doc" Savage, K4SDS

VIDEO

- 106 SERVICE CLINIC
Bits and pieces. Jack Darr

EQUIPMENT REPORTS

- 26 Engineering Specialties Model 770 Serial-Parallel Converter
- 32 Philips Model PH 3207 Oscilloscope
- 40 Global Specialties Model 3002 Capacitance Meter
- 42 Heath Semiconductor Devices Course

DEPARTMENTS

- | | |
|----------------------------------|-------------------|
| 10 Advertising and Sales Offices | 108 Market Center |
| 136 Advertising Index | 46 New Products |
| 137 Free Information Card | 8 What's News |
| 22 Letters | |

ON THE COVER

One field that has been strongly affected by microelectronics is that of photography. Once-bulky equipment is now built right into pocket-size cameras. And, in the darkroom, microprocessors are making things as easy as 1-2-3. Sony has even unveiled a completely filmless electronic-photography system. All that, and more, is covered in our special section on electronics and photography beginning on page 57.

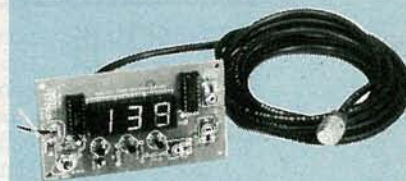

AS YOUR CAR creeps along in the stop-and-start summertime traffic, its most dangerous enemy is probably the heat. And you have no idea how badly your engine is suffering until the "Idiot light" marked "TEMP" comes on...and the radiator blows its top! This digital temperature gauge will let you know at any time exactly how hot the engine is, and allow you to cool things off before it's too late. Construction details start on page 92.

COMING NEXT MONTH

On Sale August 18

- **The Pianomatic.** An attention-getting programmable music maker you can build yourself.
- **ECL.** A tutorial on emitter-coupled logic.
- Plus lots more!

Because of lack of space, the installment of "Analog Design" scheduled to appear this month will appear in next month's issue.

Radio-Electronics, (ISSN 0033-7862) Published monthly by Gernsback Publications, Inc., 200 Park Avenue South, New York, NY 10003. Second-Class Postage Paid at New York, N.Y. and additional mailing offices. One-year subscription rate: U.S.A. and U.S. possessions, \$14.97, Canada, \$17.97. Other countries, \$22.47 (cash orders only, payable in U.S.A. currency.) Single copies \$1.50. © 1983 by Gernsback Publications, Inc. All rights reserved. Printed in U.S.A.

Subscription Service: Mail all subscription orders, changes, correspondence and Postmaster Notices of undelivered copies (Form 3579) to Radio-Electronics Subscription Service, Box 2520, Boulder, CO 80322.

A stamped self-addressed envelope must accompany all submitted manuscripts and/or artwork or photographs if their return is desired should they be rejected. We disclaim any responsibility for the loss or damage of manuscripts and/or artwork or photographs while in our possession or otherwise.

VIDEO ELECTRONICS

DAVID LACHENBRUCH
CONTRIBUTING EDITOR



BETAMOVIE ARRIVES

Loaded with innovations, Sony's *Betamovie* (see **Radio-Electronics**, April 1983) is scheduled to go on sale in the United States in November. The one-piece combination VCR-camera, which weighs less than seven pounds (including cassette and battery), is a unique product in that it's not self-sufficient but is designed to add portable movie-making to the estimated 2 million home Beta decks now in use. It has no playback capability but is merely a simple, easy-to-use recorder.

Betamovie (see lefthand photo) is equipped with a new half-inch Saticon Mixed Field pickup tube, a through-the-lens viewfinder and 6:1 zoom. It uses a standard Beta cassette and will record for three hours and 20 minutes on an L-830 cassette. To accomplish this marvel of compactness, Sony has completely redesigned the Beta tape loading and wrap systems. Abandoning its traditional "U" wrap and still preserving Beta compatibility, Sony has designed a new system using "omega" or "M" wrap similar to that used in VHS recorders. The head drum is reduced from 74.5mm to 44.7mm in diameter and the drum speed has been doubled to 60 revolutions per second. Instead of two heads at opposite sides of the drum, *Betamovie* uses a single head with two gaps, and the tape is wrapped around more than 300 degrees of the drum (versus 180 degrees in a standard Beta recorder). Thus each revolution of the smaller drum is the equivalent of one-half revolution of the conventional Beta drum.

TV WRISTWATCH

Seiko's TV-watch (see righthand photo) will be available in the U.S. in October at \$495. It has a 1.2-inch liquid crystal TV display in addition to the usual digital watch functions. The TV chassis and power supply are contained in a pocket unit. The special LCD has a base of silicon, forming an IC which creates a switching transistor for each of 31,920 dots or picture elements.

TELETEXT— WHO'S WATCHING?

With the recent inauguration of Teletext as a regular service by the FCC, networks and independent stations are starting to offer the multipage information service in the vertical interval of regular TV broadcasts. The Commission is permitting the service without establishing any standards, and at least two incompatible techniques are being used. As we reported in this column last month, CBS and NBC are using the industry-developed NABTS (North American Broadcast Teletext Specification) standard. That format is a cross between France's Antiope and Canada's Telidon, while some stations are using the British system.

If you want to receive teletext signals this year, you're out of luck unless you're quite rich or are a very intrepid constructor. A check with major receiver manufacturers showed that few, if any, had plans for any popularly priced decoders for 1983. The few professional decoders available are priced at around \$2,000. It's possible that some decoders could be available next year in the \$300-\$500 range. Matsushita, parent of Panasonic and Quasar, is developing a combination home-computer and teletext decoder for the cable-teletext system to be launched by Time Inc. That system will use a full TV channel rather than the vertical interval and will provide access to 5,000 pages of information. Whether the Matsushita decoder will work with the broadcast vertical-interval teletext is among the many undecided aspects of the inauguration of U.S. teletext, as is the price of Matsushita's attachment. (It is hoped that the decoder will sell for \$150.)

R-E

Now. Tektronix 60 MHz Performance is just a free phone call away!

Wide-range vertical sensitivity:
Scale factors from 100 V/div (10X probe) to 2 mV/div (1X probe). Accurate to $\pm 3\%$. Ac or dc coupling.

Two high-sensitivity channels: dc to 60 MHz bandwidth from 10 V/div to 20 mV/div; extended sensitivity of 2 mV/div at > 50 MHz.

Sweep speeds:
from 0.5 s to 50 ns. To 5 ns/div with X10 magnification.

Delayed sweep measurements:
Accurate to $\pm 3\%$ with single time-base 2213; to $\pm 1.5\%$ with dual time-base 2215.

Complete trigger system. Includes TV field, normal, vertical mode, and automatic; internal, external and line sources; variable holdoff.

Probes included. High-performance, positive attachment 10-14 pF and 60 MHz at the probe tip.

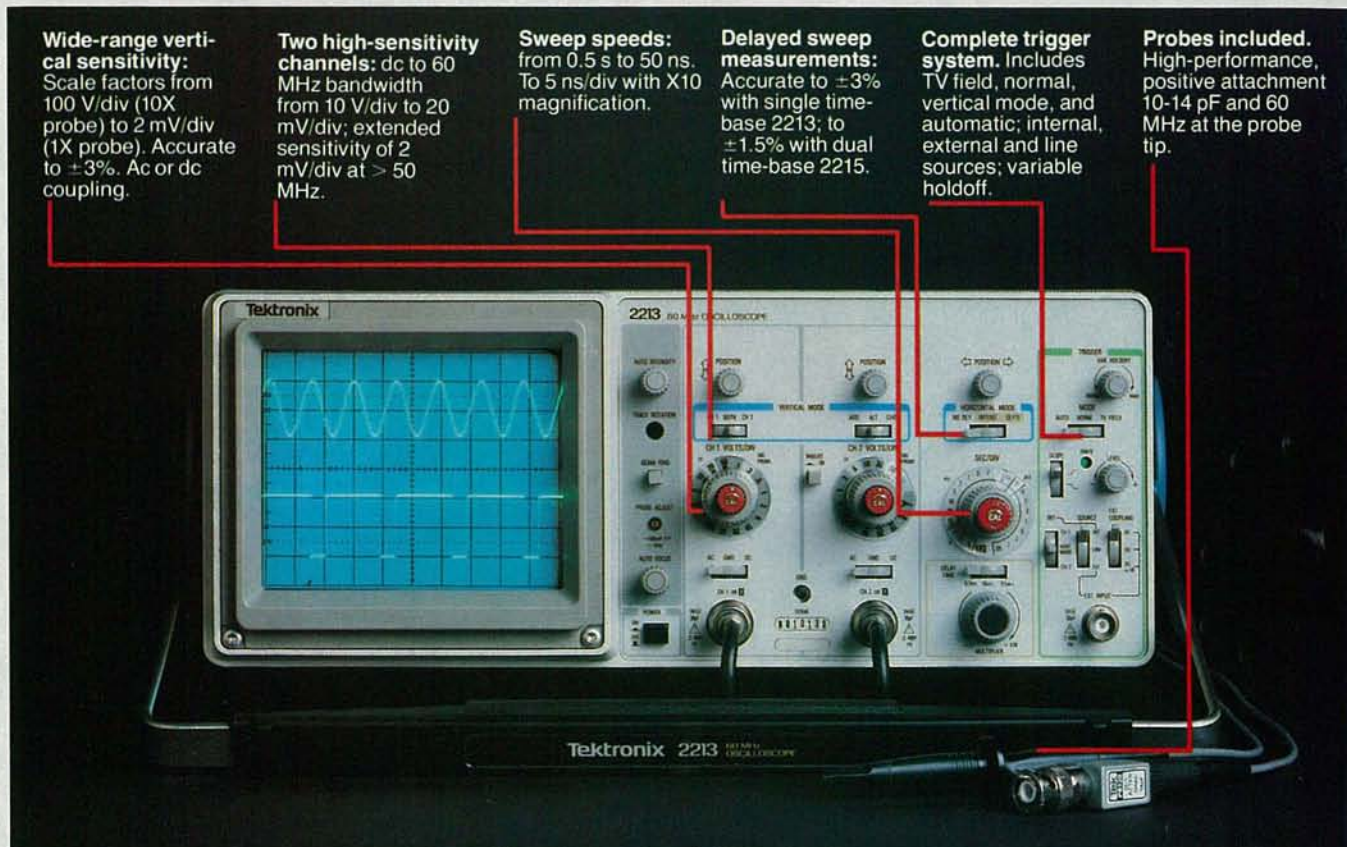

These easy to order scopes are proof that it's not expensive to have advanced, 60 MHz performance from Tektronix on your bench. It's just practical! Feature for feature, the Tek 2213 and 2215 set a price/performance standard unmatched among portable scopes. And are backed by the industry's first three-year warranty on all labor and parts, including the CRT.

So advanced they cost you less: \$1200* for the 2213! \$1450* for the dual time base 2215! These low costs are the result of a new design concept that utilizes

fewer mechanical parts than any other scope.

Yet there's no scrimping on performance and reliability. You have the bandwidth for digital and analog circuits. The sensitivity for low signal measurements. The sweep speeds for fast logic families. And delayed sweep for fast, accurate timing measurements.

Scope. Three-year warranty. Probes and expert advice. One free call gets it all!** You can order, or obtain literature, through the Tektronix National Marketing Center. Technical personnel, expert in oscil-

loscope applications, will answer your questions and can expedite delivery. Direct orders include probes, operating manuals, 15-day return policy, full Tektronix warranty and worldwide service back-up.

**Order toll free:
1-800-426-2200
Extension 42**

In Oregon call collect:
(503) 627-9000 Ext. 42

*Price F.O.B. Beaverton, OR. Price subject to change.

**Three-year warranty applies to 2000 Family oscilloscopes purchased after 1-1-83.

Tektronix
COMMITTED TO EXCELLENCE

There is a word that describes your choices in flexible disks today. That word is "ordinary." The woods seem to be full of offerings of middling quality, neither good nor bad, not necessarily cheap but not overly expensive for the most part, products that are just so-so, just average, just...well, just ordinary.

But now there's a new word in flexible disks. Ultra Magnetics. A word that redefines the state-of-the-art in flexible disk price performance rather than reinforcing the current state-of-the-marketplace. By itself, *Ultra* means "extra ordinary." And by itself is where you'll place the Ultra Magnetics product when you have a chance to compare it to others.

The superb engineering and meticulous manufacturing of each Ultra Magnetics disk clearly shows. A proprietary jacket provides more consistent jacket dimensions and lower torque that result in better auto-loading and longer life. A special lubricant built into each disk surface enhances both disk and head durability. And

100% surface testing of each and every Ultra Magnetics disk ensures the highest data reliability. Our Ultra Magnetics product line currently includes single- and double-sided 5.25-inch disks. Soon, it will feature 8-inch disks as well. For a fact, they are more expensive than some of the garden variety alternatives. But considering the performance and the reliability, Ultra Magnetics is a surprisingly attractive value.

Here's the bottom line. You no longer have to put up with what you may have sadly come to expect from flexible disks. And we encourage you to take the next logical step from the usual to the remarkable—from the ordinary to the extraordinary. Call your local supplies distributor and ask for Ultra Magnetics.



Ultra Magnetics Technology, Inc.
7 Hangar Way
Watsonville, CA 95076
(408) 728-7777

EXTRA ORDINARY



ULTRA Diskettes

Now...Diskettes you can swear by, not swear at.

Lucky for you, the diskette buyer, there are many diskette brands to choose from. Some brands are good, some not as good, and some you wouldn't think of trusting with even one byte of your valuable data. Sadly, some manufacturers have put their profit motive ahead of creating quality products. This has resulted in an abundance of low quality but rather expensive diskettes in the marketplace.

A NEW COMPANY WAS NEEDED AND STARTED

Fortunately, other people in the diskette industry recognized that making ultra-high quality diskettes required the best and newest manufacturing equipment as well as the best people to operate this equipment. Since most manufacturers seemed satisfied to give you only the everyday quality now available, an assemblage of quality conscious individuals decided to start a new company to give you a new and better diskette. They called this product the *Ultra* diskette, and you're going to love them. Now you have a product you can swear by, not swear at.

HOW THEY MADE THE BEST DISKETTES EVEN BETTER

The management of *Ultra* Magnetics then hired all the top brains in the diskette industry to make the *Ultra* product. Then these top bananas (sometimes called floppy freaks) created a new standard of diskette quality and reliability. To learn the "manufacturing secrets" of the top diskette makers, they've also hired the remaining "magnetic media moguls" from competitors such as Verbatim, Memorex, Dysan and many more. Then all these top-dollar engineers, physicists, research scientists and production experts (if they've missed you, send in your resume to *Ultra*) were given one directive...to pool all their manufacturing know-how and create a new, better diskette.

HOW ULTRA DISKETTES ARE MANUFACTURED

The *Ultra* Magnetics crew then assembled the newest, totally quality monitored, automated production line in the industry. We know that some of *Ultra*'s competitors are still making magnetic media on equipment that is old enough to vote. Since all manufacturing equipment at *Ultra* is new, it's easy for *Ultra* to consistently make better diskettes. You can always be assured of ultra-tight tolerances and superb dependability when you use *Ultra*. If all this manufacturing mumbo-jumbo doesn't impress you, we're sure that at least one of these other benefits from using *Ultra* diskettes will:

- TOTAL SURFACE TESTING** - For maximum reliability, and to lessen the likelihood of disk errors, all diskettes must be totally surface tested. At *Ultra*, each diskette is 100% surface tested. *Ultra* is so picky in their testing, they even test the tracks that are in between the regular tracks.
- COMPLETE LINE OF PRODUCTS** - For a diskette to be useful to you and your computer, it must be compatible physically. *Ultra* Magnetics has an entire line of 5 1/4-inch and 8-inch diskettes.
- SPECIALLY LUBRICATED DISK** - *Ultra* uses a special oxide lubricant which is added to the base media in the production of their diskettes. This gives you a better disk drive head to media contact and longer head and disk life.
- HIGH TEMPERATURE/LOW-MARRING JACKET** - A unique high temperature and low-marring vinyl jacket allows use of their product where other diskettes won't work. This special jacket is more rigid than other diskettes and helps eliminate dust on the jacket.
- REINFORCED HUB RINGS** - Standard on all *Ultra* mini-disks, to strengthen the center hub hole. This increases the life of the disk to save you money and increase overall diskette reliability.
- DISK DURABILITY** - *Ultra* disks will beat all industry standards for reliability at well over millions and millions of revolutions. They are compatible with all industry specifications as established by ANSI, ECMA, ISO and JIS.
- CUSTOMER ORIENTED PACKAGING** - All *Ultra* disks are packaged 10 disks to a carton and 10 cartons to a case. The economy bulk pack is packaged 100 disks to a case without envelopes or labels.
- LIFETIME WARRANTY** - If all else fails, remember, all disks made by *Ultra* Magnetics, (except bulk pack) have a lifetime warranty. If your *Ultra* disks fail to meet factory specifications, *Ultra* Magnetics will replace them under the terms of their warranty.
- SUPERB VALUE** - With *Ultra*'s automated production line, high-quality, error-free disks are yours without high cost.



SAVE ON ULTRA DISKETTES

Product Description	Part #	CE quant. 100 price per disc (\$)
8" SSSD IBM Compatible (128 B/S, 26 Sectors)	81726	1.99
8" SSDD IBM Compatible (128 B/S, 26 Sectors)	81701	2.49
8" DSSD Soft Sector (Unformatted)	82701	3.19
8" DSSD Soft Sector (1024 B/S, 8 Sectors)	82708	3.19
5 1/4" SSSD Soft Sector w/Hub Ring	50001	1.79
5 1/4" Same as above, but bulk pack w/o envelope	00153	1.39
5 1/4" SSSD 10 Hard Sector w/Hub Ring	50010	1.79
5 1/4" SSSD 16 Hard Sector w/Hub Ring	50016	1.79
5 1/4" SSDD Soft Sector w/Hub Ring	51401	1.89
5 1/4" Same as above, but bulk pack w/o envelope	00096	1.49
5 1/4" SSDD 10 Hard Sector w/Hub Ring	51410	1.89
5 1/4" SSDD 16 Hard Sector w/Hub Ring	51416	1.89
5 1/4" DSSD Soft Sector w/Hub Ring	52401	2.79
5 1/4" Same as above, but bulk pack w/o envelope	00140	2.39
5 1/4" DSSD 10 Hard Sector w/Hub Ring	52410	2.79
5 1/4" DSSD 16 Hard Sector w/Hub Ring	52416	2.79
5 1/4" SSQD Soft Sector w/Hub Ring (96 TPI)	51801	2.49
5 1/4" DSQD Soft Sector w/Hub Ring (96 TPI)	52801	3.49

SSSD = Single Sided Single Density; SSDD = Single Sided Double Density; DSDD = Double Sided Double Density; SSQD = Single Sided Quad Density; DSQD = Double Sided Quad Density; TPI = Tracks per inch.
For less than 100 diskettes, add 10% to our quantity 100 price.
For additional compatibility info call *Ultra* Magnetics at 408-728-7777.

The Small Print

To get the fastest delivery from CE of your *Ultra* computer products, send or phone your order directly to our Computer Products Division. Be sure to calculate your price using the CE prices in this ad. Michigan residents please add 4% sales tax or supply your tax I.D. number. Written purchase orders are accepted from approved government agencies and most well rated firms at a 30% surcharge for net 30 billing. All sales are subject to availability, acceptance and verification. All sales are final. Prices, terms and specifications are subject to change without notice. All prices are in U.S. dollars. Out of stock items will be placed on back order automatically unless CE is instructed differently. Minimum prepaid order \$50.00. Minimum purchase order \$200.00. International orders are invited with a \$20.00 surcharge for special handling in addition to shipping charges. All shipments are F.O.B. Ann Arbor, Michigan. No COD's please. Non-certified and foreign checks require bank clearance.

For shipping charges add \$8.00 per case or partial-case of 100 8-inch discs or \$6.00 per case or partial-case of 100 5 1/4-inch mini-discs for U.P.S. ground shipping and handling in the continental United States.

Mail orders to: Communications Electronics, Box 1002, Ann Arbor, Michigan 48106 U.S.A. If you have a Master Card or Visa card, you may call and place a credit card order. Order toll-free in the U.S. Dial 800-521-4414. In Canada, order toll-free by calling 800-265-4828. If you are outside the U.S. or in Michigan, dial 313-994-4444. Telex 810-223-2422. Order your *Ultra* diskettes from Communications Electronics today.

Copyright ©1983 Communications Electronics™

Ad #050583



Order Toll-Free!
800-521-4414
In Michigan 313-994-4444

ULTRA
MAGNETICS
diskettes

COMMUNICATIONS
ELECTRONICS™

Computer Products Division

854 Phoenix □ Box 1002 □ Ann Arbor, Michigan 48106 U.S.A.
Call TOLL-FREE (800) 521-4414 or outside U.S.A. (313) 994-4444

CIRCLE 28 ON FREE INFORMATION CARD

WHAT'S NEWS

Ohio court throws out radar evidence

Judge Anthony M. DeJute, of the Defiance, OH, municipal court, has ruled that a reading taken by a K-55 radar used in the moving mode is "not the subject of judicial notice."

The decision was the result of a test case in which over 600 pages of expert testimony and numerous exhibits were introduced; the case also featured verbal testimony by two recognized experts in the field of police traffic radar. The trial lasted three days.

The court indicated that continued judicial notice would be taken of the K-55's accuracy when used in the stationary mode.

G.E. entering home telephone market

The Audio Electronics Products Department of the General Electric Co. has introduced a line of home telephones, a totally new addition to the company's consumer-product line.

The new Advantage series includes five models, ranging from the standard model 2-9100 desk or wall telephone (with such features as *Versa-dial* pushbutton dialing, one-touch re-dial, and lighted keypad) for a suggested retail price of

\$43.95, to the model 2-9650, a maximum-range, cordless telephone system with continuous anti-piracy and clear-channel privacy features, at a suggested price of \$199.95. The line also contains two clock-radio telephone combinations.

Reliability, states the company, was the keynote in developing the new line, and all models come with a two-year warranty, except the cordless phone, on which the warranty is one year.

Historic call sign revived in England

The call 2MT—initially used to introduce Britain's first regularly scheduled entertainment broadcasts—is being revived after 60 years.

It was first issued in 1920 to the Marconi Co., which was given an experimental license for broadcasting news bulletins. That license was revoked when a musical program was broadcast.

Later, after an appeal from the Wireless Society of London (now the Radio Society of Great Britain) the call was issued again, this time without the "news only" limitation. The first entertainment broadcast in the United Kingdom was transmitted on 700 meters (429 kHz) under that call sign. That transmis-

sion took place on Feb. 14, 1922, at Writtle, which is near Chelmsford, England.

The license restricted broadcasting to a half hour each Tuesday. The station was required to cease transmitting three minutes in every ten, in order to check for complaints.

The reissued call (now G2MT) has been granted to the Marconi Radio Society, a new group formed by amateurs employed by Marconi Space and Defense Systems, Ltd., (MSDS). The Society enjoys the use of the Company's facilities, and its president is Dr. W. Bardo, Technical Director of MSDS.

Funtastic signs with The Games Network

Funtastic, Inc. has leased the cable-television rights for its games to The Games Network, a new cable-delivered videogame programming service. Funtastic's best seller, *Snack Attack*, will be one of the first games offered by the new service.

The new network is viewed as an additional revenue source for videogame manufacturers and designers; it will pay royalties for games offered on the service. It is also expected to provide a test market for new games.

The Games Network will offer a variety of videogames in both educational and entertainment formats. Cable viewers will pay a monthly fee, and will be able to choose from a selection of 20 games, at least five of which will be rotated monthly. The service is expected to start late this year.

Laser disc narrates the life of Van Gogh

A new optical laser videodisc, "Vincent Van Gogh; a Portrait in Two Parts," has been pressed by North American Philips to demonstrate the capabilities of its *LaserVision* system. One side of the disc is a one-man play, "Vincent" starring Leonard Nimoy, television actor and Van Gogh buff; the other: "Van Gogh Revisited," is a study of the artist's life and works.

Narrated by Mr. Nimoy, "Van

Gogh Revisited" consists of 16 chapters, plus 677 still frames featuring the works of Van Gogh, as well as those of other artists. The disc takes advantage of the interactive features of the *LaserVision* system by using two separate audio tracks—thus offering two different types of commentary—and by indexing over 200 works of art, which can be accessed at will by the viewer.

"We felt an upscale, state-of-the-art videodisc was needed to show conclusively the vast resources of the *LaserVision* system," stated John Messerschmidt, vice president of North American Philips. To see in person everything offered on this disc, a viewer would have to spend an evening in the theater, travel to 46 art museums, refer to a variety of art books, and also attend several lectures.

Though Philips is marketing the disc—available at selected video and department stores—it has no intention of entering the videodisc program-production business. Videodiscs are now being produced by 14 companies.

New 3-D viewer

The Bright and Morning Star Co. of Lawndale, CA, has received U.S. patent 4,235,515 for a 3-D viewing system that requires no special glasses, filters, or similar encumbrances commonly associated with stereo viewing in autostereoscopic systems. The viewer, however, must be positioned in front of and at "a comfortable distance" from the viewing unit—between 12 and 24 inches. As the positioning is not critical, a hand-held viewer may be used.

Standard left-right pairs of images are required. A removable external device adapts home, moving picture, X-ray, or TV-cameras to produce such image pairs for display by the system.

The heart of the display system is a sandwich of Fresnel lenses. Since the lines of sight from the viewer's left and right eyes are not parallel, they enter the sandwich at slightly different angles of incidence. One of the lines of sight strikes the sandwich at an angle great enough to undergo total internal reflection from one of the

continued on page 10



THE NEW GENERAL ELECTRIC ADVANTAGE SERIES. Clockwise from far left: *Wake-Up-Call*, model 7-4700; *Call-Maker*, model 7-4705; cordless telephone *Voyager*, model 2-9650 (shown with its recharging cradle); *Hotline*, model 2-9250, and standard full-feature telephone, model 2-9100.



affordable precision

Excellence by Design

BBC has been building multimeters and other instrumentation for European engineers and technicians for over 7 decades. And now, twelve advanced technology BBC meters with a complete line of accessories are available in the U.S. Prices range from under \$50.00 to \$595.00. No other manufacturer offers you comparable price and performance values.

Forms that Follow Function

To achieve a family of "hands free" instrumentation designed for heavy-duty use in a wide variety of environments, BBC relied on the industrial design skills of the Porsche Design Studios. You'll like the results.

The unique folding design lets you adjust the viewing angle. Extra large LCD displays make the meters easy to read. The exclusive function and range switch is logically laid out. And the folding meters even turn off automatically when you close the case.

Accuracy Where it Counts

Precision is a tradition at BBC. The 3 1/2 digit folding models feature 0.1% basic dc accuracy. For higher precision measurements, the model MA 5D delivers 0.05% basic dc accuracy and 30,000 counts.

Precision Values

Some of the best news about BBC meters is that you can get them for less than you've been paying for old technology meters. They are built to the world's highest safety standards, VDE/DIN, and are backed by one of the strongest warranties in the industry.

Local Availability

BBC has worked hard to make these meters available through leading U.S. distributors and representatives. There is an outlet close to you. And, if your instrumentation supplier doesn't carry BBC yet, we'll gladly tell you who does. Call toll free: **1-800-821-6327**. (In CO, 303-469-5231)

BBC-METRAWATT/GOERZ

6901 W. 117th Avenue
Broomfield, CO 80020
Telex 45-4540
(303) 469-5231

Send me information on BBC meters.

I'd like to be on your mail list.

Fast-Response Coupon



Name _____

Title _____

Company _____

Address _____

City _____ State _____ Zip _____

Telephone (_____) _____

Engineering Excellence in Test and Measurement



CIRCLE 60 ON FREE INFORMATION CARD

WHAT'S NEWS

continued from page 8

lenses, and is directed to an area where one of the stereo images is presented to it. The other line of sight, entering the sandwich at an angle not great enough to undergo total reflection, is transmitted through the lenses with only slight refraction, and strikes the other stereo image.

The observer's lines of sight have been separated and directed in two discrete directions, and he sees a right and left image with the corresponding eyes. Thus he sees three-dimensionally.

The company suggests that licensees can construct equipment for a wide variety of sizes and uses—ranging from 35-mm photography to videogames—and for a wide range of technical photography, too.

New AM stereo decoder IC introduced by Motorola

Motorola's semiconductor products division has announced the introduction of an IC AM-stereo decoder that's compatible with Motorola's C-QUAM AM-stereo broadcasting system. That system has already been adopted by a number of radio stations; and late last year, the Delco division of General Motors recommended that it be used in future GM car radios.

In the C-QUAM, or Compatible QUadrature Amplitude Modulation system, the L + R and L - R signals are encoded by amplitude-modulating them onto two carrier signals. The signals are at the same frequency, but 90 degrees out of phase. The result is a true L + R carrier envelope. For mono

reception, that signal is multiplied by the cosine of the resulting phase angle.

The new IC, designated MC13020P by Motorola, will be the heart of an AM stereo receiver and takes the place of the standard detector in a conventional AM radio. It requires a 200-mV IF signal and produces about 100 to 200 mV of audio. It requires few external components—just a small number of resistors and capacitors as well as an inexpensive ceramic resonator for the phase-locked reference oscillator. The introductory price of the IC, in quantities of 100 to 999, is \$2.33 each.

The Source, Control Data Corporation join forces

An agreement has been reached between Control Data Corporation and The Reader's Digest Association under which Control Data has invested in Source Telecomputing Corporation, Reader's Digest's videotex subsidiary. STC's primary service is The Source, a videotex and information database service.

According to Walter Bruning of Control Data, "The Source is one of the foremost information services in the nation. As such, it offers real potential for us in expanding the channels for computer-based information services to individuals and business enterprises. Control Data's long experience with delivering computer services will complement the strong information orientation of Reader's Digest."

The Source provides information and communications services

to over 33,000 subscribers for use with personal computers, terminals, or communicating word processors. Under terms of the agreement, Reader's Digest will retain its controlling interest in STC.

RCA prepares for growing video display business

RCA has set up a Video Component and Display Division as the company's primary business focus for the OEM (Original Equipment Manufacturer) sale of video display products for computer and other commercial and industrial applications.

A standard line of video monitors for consumer and industrial use is planned. The majority of those will be designed for color-video displays with improved resolution.

Predicting that the display business is expected to quadruple by 1990, Roy H. Pollack, RCA executive vice president, reported that the company is already heavily involved in video display, and has been particularly successful with TV surveillance equipment and with video monitors sold to the educational market.

Voice recognition/synthesis for videogames

The Milton Bradley Co. of Springfield, MA, one of the world's largest manufacturers of games and educational materials, has contracted with Atari, Inc., Sunnyvale, CA, to manufacture a plug-in peripheral containing voice synthesis and voice recognition for Atari's 2600 and 5200 videogame consoles.

The plug-in will be sold with a headset/microphone that allows the player to voice-control the videogame action. "The addition of voice synthesis and recognition marks the first time that this technology has been applied to home-videogame consoles. It provides the consumer with added excitement and involvement," says an Atari spokesman.

Milton-Bradley will also develop codes for a total of 18 Atari cartridges over a three-year period. Most of them will use voice capabilities.

Radio-Electronics

Hugo Gernsback (1884-1967) founder

M. Harvey Gernsback, editor-in-chief

Larry Steckler, CET, publisher

Arthur Kleiman, editor

Josef Bernard, K2HUF, technical editor

Carl Laron, WB2SLR, associate editor

Brian C. Fenton, assistant editor

Jack Darr, CET, service editor

Robert F. Scott, semiconductor editor

Herb Friedman, communications editor

Gary H. Arlen, contributing editor

David Lachenbruch, contributing editor

Earl "Doc" Savage, K4SDS, hobby editor

Danny Goodman, contributing editor

Dan Rosenbloom, production manager

Robert A. W. Lowndes, production associate

Joan Roman, circulation director

Arline R. Fishman, advertising coordinator

Cover photo by Robert Lewis

Radio-Electronics is indexed in *Applied Science & Technology Index* and *Readers Guide to Periodical Literature*.

Gernsback Publications, Inc.
200 Park Ave. South
New York, NY 10003
President: M. Harvey Gernsback
Vice President: Larry Steckler

ADVERTISING SALES 212-777-6400

Larry Steckler
Publisher

EAST/SOUTHEAST

Stanley Levitan
Radio-Electronics
200 Park Ave. South
New York, NY 10003
212-777-6400

MIDWEST/Texas/Arkansas/Okla.

Ralph Bergen
Radio-Electronics
540 Frontage Road—Suite 325
Northfield, Illinois 60093
312-446-1444

PACIFIC COAST Mountain States

Marvin Green
Radio-Electronics
413 So. La Brea Ave.
Los Angeles, Ca 90036
213-938-0166

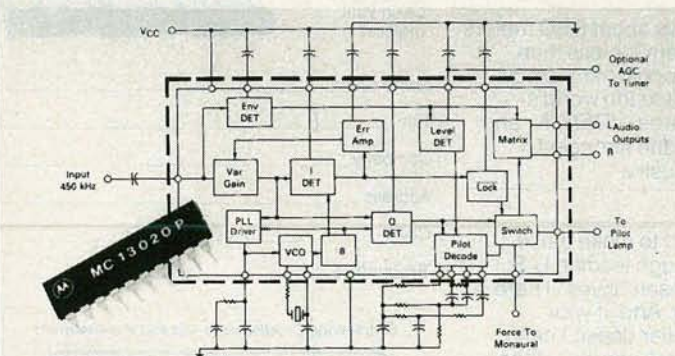

BLOCK DIAGRAM of the new Motorola AM-stereo decoder shows the internal functions of that complex IC.

INTRODUCING the world's first, affordable teaching robot...

HERO¹ the most sophisticated microprocessor-controlled device since the microcomputer.

HERO 1 is a completely self-contained, electro-mechanical robot capable of interacting with its environment. Controlled by an on-board, programmable computer, it has electronic sensors to detect light, sound, motion and obstruction in its path.

Capable of seven axes of mo-

tion, the robot can be programmed to pick up small objects with its arm. It will also speak in complete sentences, using its voice synthesizer.

Remarkable though the robot is,

its companion **Robotics Education Course** is an even more significant "first." It provides

a thorough understanding of robot technologies, including robotics programming. Course features self-test unit reviews, experiments and final exam.

Designed to be used with HERO 1, this 1200 page course is the most complete introduction to robotics available today.

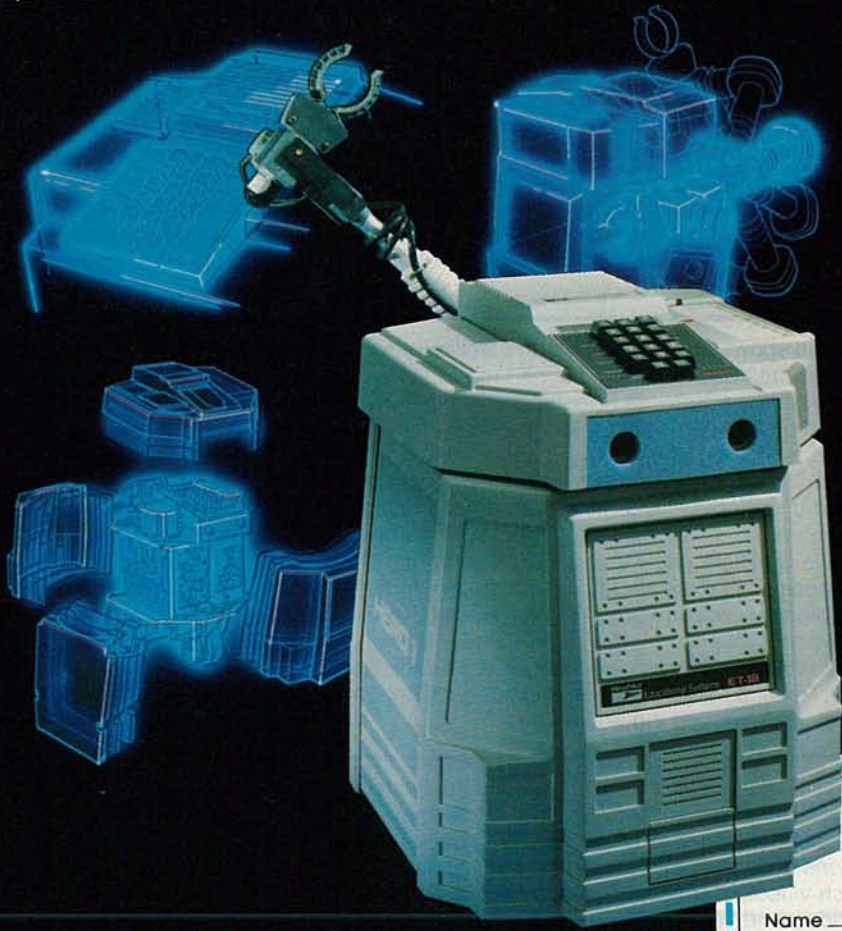
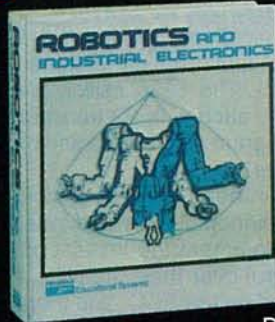

HERO 1 is a computer on wheels.

HERO 1 uses a 6808 microprocessor that controls 13 functions and sense boards. Its on-board processor can take it through complex maneuvers. The programming process is straightforward with provision for step-by-step debugging, enhancement and other corrections.

HERO 1 senses include: sound detection (frequency range 200-5000 Hz); light detection; ultrasonic ranging; ultrasonic motion detection; speech synthesis; and real time, four year calendar clock.

A completely mobile platform robot, HERO 1's motion abilities permit head rotation and arm rotation of 350°, shoulder rotation of 150°, arm extension of 5 inches, wrist pivot of 180° and wrist rotation of 350°. Gripper will open to a maximum of 3½ inches and rotate 90° at extreme extension. Payload capacity of arm is 8 oz. at maximum extension and 16 oz. at normal.

The remarkable HERO 1 robot is in production now, ready for you. Buy assembled or build it from a kit. Kit price is \$1500 and the assembled robot is \$2500, FOB Benton Harbor, or through your nearest Heathkit Electronic Center.

For full information on HERO 1 call 800-253-0570 toll-free. (In Alaska, Hawaii and Michigan, call 616-982-3411.) We'll give you the address of the nearest Heathkit Electronic Center and send you a booklet that gives details about the robot, the content of this course, and other information.

Please send details on the HERO 1 robot and robotics course.

Mail to: Heath Company, Dept. 020-088
Benton Harbor, MI 49022

Name _____

Address _____

City _____

State _____ Zip _____

Heathkit / Zenith Educational Systems is a division of Heath Company,
Benton Harbor, Michigan 49022. RO-100AR1

Heathkit[®]
Heathkit / Zenith
Educational Systems

SATELLITE/TELETEXT NEWS

GARY ARLEN
CONTRIBUTING EDITOR

PRIVATE SATELLITES

Orion Satellite Corp., a new telecommunications firm, wants to launch an ambitious satellite project that would put two birds over the Atlantic, mainly for transmission of *international* video and data between Europe and the U.S. The \$230 million plan envisions lofting the two high-power birds in 1986 or early 1987, each with 22 transponders that would be sold or offered on long-term leases to video-program distributors and private companies who would use the circuits for a variety of purposes.

Orion's plan puts the new company in head-to-head competition with Intelsat, the consortium of 108 nations that now has a monopoly on world satellite services. But officials at Orion insist that their satellites will complement the Intelsat offerings, especially by giving heavy video and data users more control over their circuits.

The Orion proposal must be approved by the FCC, and there is already speculation that government officials will try to discourage the effort for fear that other potential international satellite operators may seek to establish similar services if the Orion plan is approved. The Orion management group has strong ties to the cable-TV and telecommunications industries in the U.S.—posing interesting prospects for the new company. Details, including orbital slots for the birds, launch specifications, and transmission systems, are not yet developed.

WEATHER SATELLITES

The Reagan Administration wants to sell the nation's four weather satellites and a low-flying land-survey satellite to private industry as part of a cost-cutting effort; the private operator would then operate the satellites and sell data back to the government's weather service.

Among the first companies to respond to the plan was Comsat, which put together a proposal called "EarthStar." It calls for spending about \$300 million to buy the weather-satellite system, and then operate it for about \$600 million less during the first five years than it now costs the government. However, Comsat's proposal—and other possible plans—may face legal hurdles from skeptics who don't want the government to give up ownership of those satellites.

NEW SATELLITE PROGRAMMING

More shopping shows are popping up on satellite networks. *The TV Auction*, an hour-long videotape of an auction at the San Jose Flea Market, is carried several times a week on Satellite Programming Network (Westar IV, transponder 11X). Home viewers can phone in orders as the merchandise is auctioned at the flea market, buying products at the auction-sale price. Another shopping show, *The Sharper Image Living Catalog*, features merchandise from the slick *Sharper Image* mail-order catalog; that one is carried on SPN, Modern Satellite Network, and on selected local-origination cable channels.

There's also more music aloft. Satellite Music Network will use the audio subcarrier of Times Mirror's Spotlight pay TV channel (Satcom III, transponder 4) for a number of new formats, extending the three all-day radio formats which SMN now offers. Mutual Broadcasting and Doubleday media are programming *Rock USA*, a new three-hour weekly album-rock program in stereo. Meanwhile, the popular new national newspaper *USA Today* is heading into satellite radio, developing a series of daily radio features drawn from stories in the newspaper. Three 60-second programs will be beamed daily via Mutual radio's satellite network to stations around the country.

TELETEXT AND VIDEOTEX BITS

J.C. Penney, the giant retail chain, has bought the FirstHand videotext system developed by a Minneapolis banking firm and expects to roll the service out as a national facility for electronic home banking, shopping, and information retrieval. Penney will invite other financial institutions and information companies to join in the FirstHand service, which has been using French videotext (Antiope) technology.

United Video and Weatherscan International have set up the first complete satellite-fed weather information service, Zephyr Weather Transmission. The data will be sent via UV's vertical blanking interval to independent meteorologists, airlines, broadcast stations, and others needing instant weather data.

Atari's mystery-cloaked "Project Falcon" is coming out of the shadows—and it will include some teletext-like features. Ataritel, a package of communications services, including a smart electronic telephone/computer system, is expected later this year.

R-E

We gave solderless breadboarding a new name.

Proto-Board® breadboards, by Global Specialties. The leading name in solderless breadboarding.

You find them wherever electronics is important. From labs to production lines to classrooms to home workshop benches. Their name, synonymous with solderless breadboarding. And for good reason.

Proto-Board breadboards introduced engineers, technicians and hobbyists to a new way

of designing and building electronic circuits: as fast as they can think. Testing, modifying and expanding as quickly as new thoughts occur. Saving precious time and money by freeing creativity from manual labor.

Global Proto-Board products are arrays of solderless sockets and bus strips that emulate PC board layouts

while permitting instant insertion and removal of components from the largest DIP to the smallest discretes. With a rugged construction built to provide positive connections and withstand day-in, day-out professional use—even as test fixtures. And mounted on sturdy metal backplanes, for extended high-frequency use and extra durability.

Their value and versatility are why so many professionals and hobbyists are "Proto-Board"-ing. And why you should be, too.

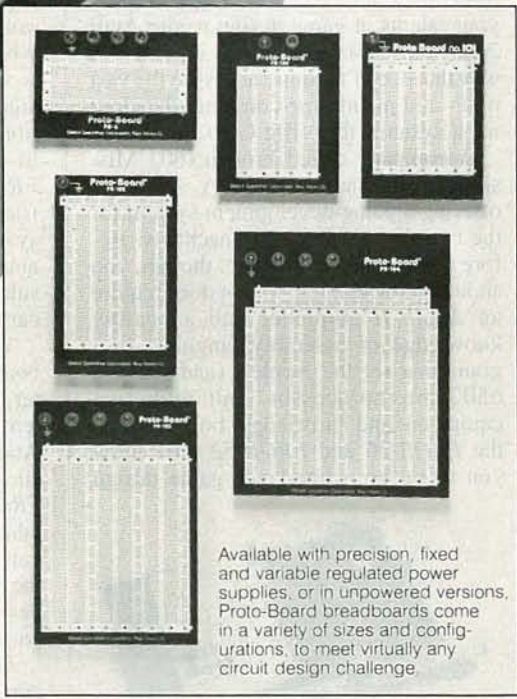
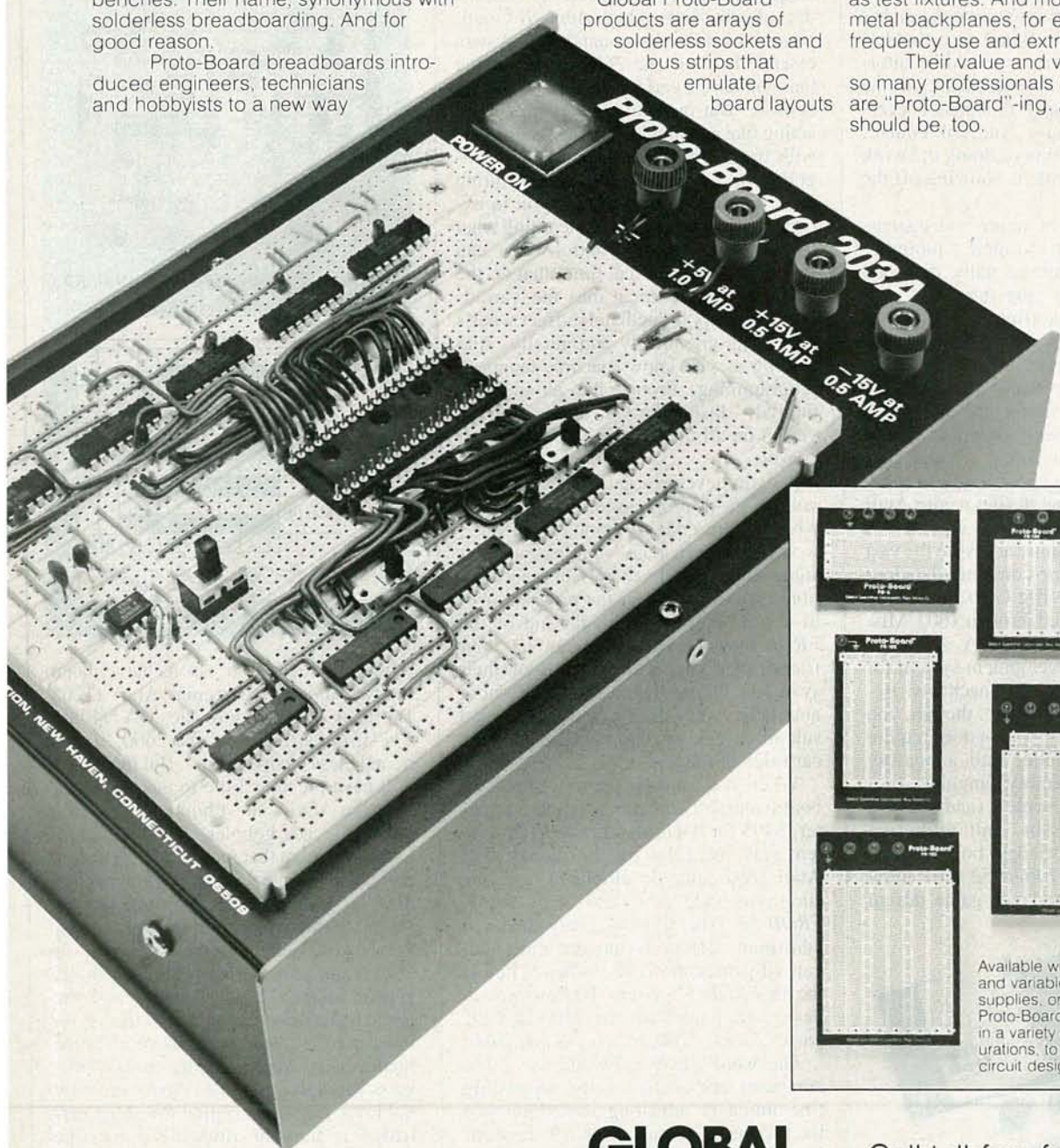

Available with precision, fixed and variable regulated power supplies, or in unpowered versions. Proto-Board breadboards come in a variety of sizes and configurations, to meet virtually any circuit design challenge.

70 Fulton Terr. New Haven, CT 06509 (203) 624-3103, TWX 710-465-1227
 OTHER OFFICES: San Francisco (415) 648-0611, TWX 910-372-7992
 Europe: Phone Safron-Walden 0799-21682, TLX 817477
 Canada: Len Finkler Ltd., Downsview, Ontario

GLOBAL SPECIALTIES CORPORATION

© Copyright 1981 Global Specialties Corporation.

Call toll-free for details
1-800-243-6077
 During business hours

CIRCLE 31 ON FREE INFORMATION CARD

AUGUST 1983

13

VIDEOGAMES

Do-it-yourself games

DANNY GOODMAN, CONTRIBUTING EDITOR

THE DO-IT-YOURSELF PHENOMENON HAS affected almost every aspect of life in this country. If there is a task requiring an expensive professional, you can be sure that someone has written a book, or has packaged a set of tools and parts that lets the weekend carpenter, would-be attorney or shade-tree auto mechanic get the job done more cheaply, though not necessarily more quickly. And, of course, there's the satisfaction of doing the work yourself and the pride in showing off the finished product.

But the world of home videogames may seem off-limits to mere "mortals" who must buy professionally designed game cartridges to plug into their consoles. In the meantime, the "David Cranes" of the industry get all the glory for their design work.

There are surely many game players out there—perhaps you are one—who have great game ideas, or would like to try their hand at inventing a better Pac-Man. Well, now you have a way to apply your talents at game design to the Atari 2600 and 5200 videogame systems—a way that doesn't require access to the vast mini- and mainframe-computer development systems the "Big Guys" use.

A company called Frobco (603 Mission Street, Santa Cruz, CA 95060) is offering a game-development system for the two Atari videogame machines. Before you rush out to buy one, though, you should know that the system does require an Apple II computer and a healthy knowledge of assembly language programming for the Apple's (and Atari's) 6502 microprocessor. But with that equipment and knowledge, both models, the FROB-26 and FROB-52 will allow you to set up a free-lance game design

The FROB-26, shown in Fig. 1, comes with an accessory card for the Apple II computer, a couple of 2600 cartridge adapters, a cable that connects between the cartridge slot and the Apple II board, plus software and manuals. The system essentially fools the 2600 into thinking that you have a cartridge plugged into the console. But in reality, your Apple II is acting like a dynamic cartridge, complete with the ability to download game programs onto disk for retrieval and editing later. FROB software allows you to experiment inside the 2600 by learning what the various registers control. You can program the unit in real time, that is, the instructions you enter into the various 2600 registers immediately affect what's happening graphically and aurally. And as long as you know machine-language programming, Frobco has an in-depth tutorial, "Inside the VCS," that will fill you in on all the technical details of the console.

As you develop a game, you can save your work-in-progress on a disk. And when you're done (a game, like Rome, won't be built in a day—professional designers take months to perfect their creations) you can transfer the program over to a 2732 EPROM with the aid of the FROB-Burner. Then you can let your friends play your game directly on their systems. Or perhaps, if you're more ambitious, you will take the bold step and submit your game to the major videogame cartridge producers.

When you consider the cost of add-on boards and software for the Apple computer, \$495 for the basic 4K FROB-26 system gets you a lot for the money. For Atari 5200 game development, you can simply upgrade the FROB-26 to the 4K FROB-52. That upgrade only costs an additional \$195. To design more advanced games, however, a better buy is the 8K FROB-52 system. It allows you to design 4K games for the 2600 and 8K games for the 5200; the cost is just \$990.

The word "frob," by the way, is a computer enthusiast's term suggesting fine-tuning or adjusting something just for the fun of seeing what will happen. But lest you think the FROB systems are just for mindless computer acrobatics, you should know that serious game designers at Activision, Coleco, and Atari use FROB systems to develop the cartridges you're buying today.

Atari Ms. Pac-Man for Atari 2600



CIRCLE 101 ON FREE INFORMATION CARD

Ms. Pac Man											Atari	
GRAPHICS												
SOUND												
EASE OF LEARNING												
CHALLENGE												
VALUE												
	1	2	3	4	5	6	7	8	9	10		
	Poor		Fair			Good			Excellent			

Although few good words have been uttered about the original Atari (1265 Borregas Ave., Sunnyvale, CA 94086) Pac-Man cartridge for the 2600, it was nonetheless a popular one. But the critics will have precious little to quibble about over the Atari's latest home version of a popular arcade gobbler, Ms. Pac-Man.

It is apparent that more effort went into recreating the arcade aura of the original Ms. Pac-Man. All the characters closely resemble their coin-op counterparts: Ms. Pac-Man herself has a bow in whatever Pac creatures use for hair, the four ghosts appear in their proper colors, and the game features bouncing bonus fruit symbols, not the featureless box of its home predecessor. Mazes change as you progress through the game. About the only holdover from the original Pac-Man cartridge is that the dots are more like dashes.

For those who have not played the arcade version, Ms. Pac-Man differs from Pac-Man primarily in that the maze changes every other time your Ms. Pac-

continued on page 20



FIG. 1

business right from your family's living room.

HITACHI

NLS Non-Linear Systems

HICKOK

WESTON

DATA PRECISION

KEITHLEY

AWS
A.E. SPEER
INSTRUMENTS CO.

FLUKE

PHILIPS

BK PRECISION

VIZ R&A

TRIPLETT

Simpson

LEADER

BECKMAN'S CIRCUITMATE AVAILABLE NOW ALL UNDER \$100

Circuitmate DM 20—3½-digit, pocket-size multimeter; 0.8% Vdc accuracy, diode test, hFE test, conductance, 10 amps AC and DC ranges, auto-polarity, auto-zero, auto-decimal

\$64⁹⁵

Circuitmate DM 40—3½-digit multimeter; 0.8% Vdc accuracy, diode test, auto-polarity, auto-zero, auto-decimal

\$69⁹⁵

Circuitmate DM 25—3½-digit, pocket-size multimeter; 0.5% Vdc accuracy, diode test, capacitance, continuity beeper, conductance, 10 amps AC and DC ranges, auto-polarity, auto-zero, auto-decimal

\$79⁹⁵

Circuitmate DM 45—3½-digit multimeter; 0.5% Vdc accuracy, diode test, continuity beeper, 10 amps AC and DC ranges, auto-zero, auto-polarity, auto-decimal

\$89⁹⁵

HITACHI

A 30 MHz SCOPE AT A 15 MHz PRICE

WE CARRY
A FULL LINE
OF HITACHI
OSCILLOSCOPES

CALL FOR
OUR PRICES

\$549⁹⁵

V-302

Dual Trace w/Delay

All Hitachi Oscilloscopes feature
2 year parts and labor warranty.

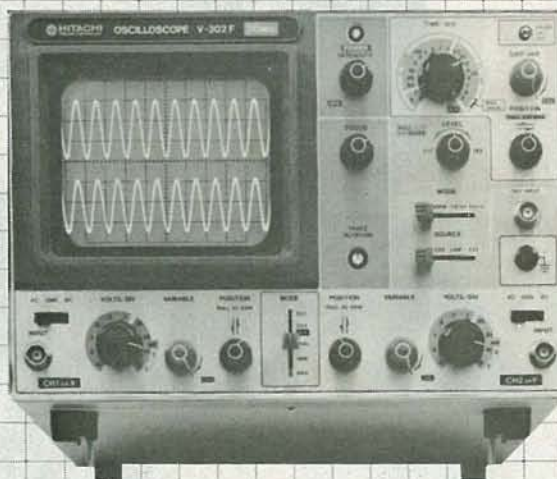

Price does not include probes.
Probes \$50. a pair when purchased with scope. \$10. shipping within continental U.S.

- Mastercharge & Visa shipped within 24 hours.
- Bank checks or Money Orders shipped within 24 hours.
- Personal checks — please allow 3 weeks for check to clear.



TOLL FREE HOT LINE
800-223-0474

THE TEST EQUIPMENT SPECIALISTS

ADVANCE ELECTRONICS

26 WEST 46th STREET, NEW YORK, N.Y. 10036 212-730-7030

Now NRI takes you inside the TRS-80 Model III microcomputer with disk drive to train you at home as the new breed of computer specialist!

NRI Teams Up With Radio Shack Advanced Technology
To Teach You How To Use, Program, and Service
State-of-the-Art Microcomputers.



It's no longer enough to be just a programmer or a technician. With microcomputers moving into the fabric of our lives (over 250,000 of the TRS-80™ alone have been sold), interdisciplinary skills are demanded. And NRI can prepare you with the first course of its kind, covering the complete world of the microcomputer.

Learn At Home In Your Spare Time

With NRI training, the programmer gains practical knowledge of hardware, to design simpler, more effective programs. And, with advanced programming skills, the technician can test and debug systems quickly and easily.

Only NRI gives you both kinds of training with the convenience of learning at home. No classroom pressures, no night school, no gasoline wasted. You learn at your convenience, at your own pace. Yet you're always backed by the NRI staff and your instructor, answering questions, giving you guidance, and available for special help if you need it.

You Explore the TRS-80 Model III Inside and Out

NRI training is hands-on training, with practical experiments and demonstrations as the very foundation of your knowledge. You not only learn to program your computer, you learn all about it . . . how circuits interact . . . interface with other systems . . . gain a real insight into its nature. Under NRI's carefully planned training, you even install a DISK DRIVE verifying its operation at each step.

You also work with a professional

4-function multimeter, featuring full portability and a 3½-digit liquid crystal display. Using it along with the exclusive NRI Discovery Lab® and your TRS-80, you perform over 60 separate experiments. You learn how to troubleshoot and gain greater un-

derstanding of any microcomputer from the information your testing procedures give you.



Now training includes either the TRS-80 Model III Microcomputer with Disk Drive or TRS-80 Color Computer with Computer Access Card; professional LCD multimeter; the NRI Discovery Lab; and hundreds of demonstrations and experiments.

derstanding of any microcomputer from the information your testing procedures give you.

TRS-80 Model III With Disk Drive Is Yours To Keep

As part of your training, NRI sends you the TRS-80 Model III microcomputer plus DISK DRIVE. This functional unit is complete with 65-key keyboard and 12" display in one desk-top unit. Its 32 RAM is internally expandable to 48K and its BASIC language is compatible with most Model I software. It features built-in interface for parallel printer and disk drive which allows for high speed storage and rapid access and manipulation of data. This ensures a powerful and versatile computer at your command.

Along with your multimeter and the NRI Discovery Lab, this latest concept in advanced microcomputers is yours to learn

Same Training Available With Color Computer

NRI offers you the opportunity to train with the TRS-80 Color Computer as an alternative to the Model III. The same technique for getting inside is enhanced by using the new NRI-developed Computer Access Card. Only NRI offers you a choice to fit your specific training needs.

Send For Free Catalog

Get all the details on this exciting course in NRI's free, 104 page catalog. It shows all equipment, lesson outlines, and facts on other electronics courses such as Electronic Design, Industrial Electronics, TV/Audio/Video Servicing . . . 12 different career opportunities in all.

Send today. Prepare to take advantage of the incredible job and earnings possibilities of the microcomputer revolution as you learn on the world's most popular computer. If postcard has been used, write to NRI Schools, 3939 Wisconsin Avenue, Washington, DC 20016.

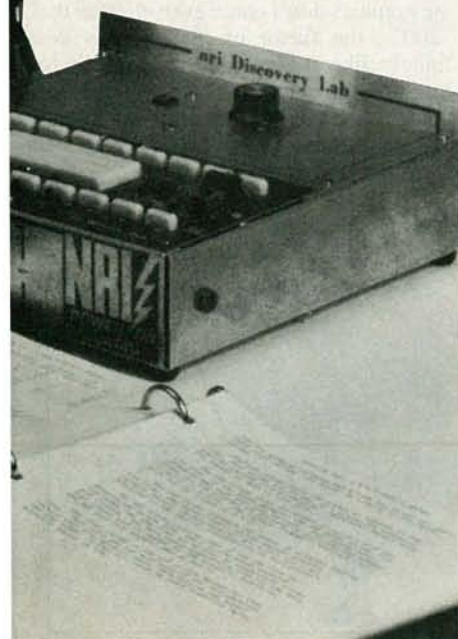
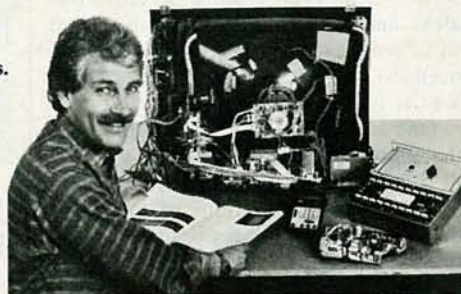

(TRS-80 is a trademark of the Radio Shack division of Tandy Corp.)

NRI **NRI Schools**
 McGraw-Hill Continuing
 Education Center
 3939 Wisconsin Ave.
 Washington, D.C. 20016
We'll give you tomorrow.

VIDEOGAMES

continued from page 14

Man character clears the screen of dots. Three of the four different mazes in the cartridge have two escape tunnels off the sides of the screen. The third maze has a single escape tunnel.

The other major difference is that instead of the bonus fruit appearing as stationary objects below the ghost pen, they bounce around the maze in *Ms. Pac-Man*.

Sound is much improved on this cartridge. When you reset the game from the joystick, the *Ms. Pac-Man* music theme is played in two voices, a programming feat that, until recently, was considered impossible on the 2600.

Game play is not exactly child's play. The ghosts are very aggressive, even on the first couple of screens. Nor are they easily fooled by dodging around corners. According to the instructions, the ghosts' "blue"-time (length of time that the ghosts are blue after *Ms. Pac-Man* gobbles an energy pill) is supposed to decrease with every successful clearance of the board. That is definitely true for the first seven or eight screens. But after that, the blue-time, though indeed short, seems to remain constant. A ghost needs to be right on *Ms. Pac-Man*'s tail for her to catch it after she eats a pill.

One advantage of a home game over the coin-op version—other than the lack of a coin slot—is that the home version can incorporate variations of the game that help newcomers get used to the action. In *Ms. Pac-Man*, there are a total of four variations. There is "regulation play" with four ghosts, and variations with one, two, and three pursuing ghosts. Those last three are identified on the screen legend with one to three teddy-bear heads—presumably intended for children. But there will be non-game playing adults who will rather begin at the one or two-bear level.

Ms. Pac-Man is a fine example of an arcade translation conceived with ample time and thought. If you held off buying the first *Pac-Man* cartridge, don't hesitate about this one. On the other hand, if you already own the male version of the game, you probably won't see enough difference in the female version to make it worth the investment. Just the same, *Ms. Pac-Man* marks a noticeable improvement in the quality of Atari-produced games cartridges for their 2600 videogame system.

Atari Centipede for Atari 5200

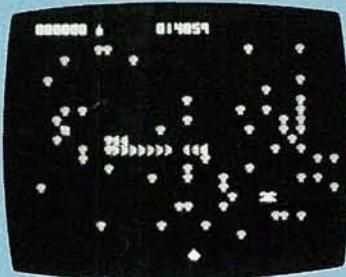

CIRCLE 102 ON FREE INFORMATION CARD

Centipede	Atari									
GRAPHICS	█	█	█	█	█	█	█	█	█	█
SOUND	█	█	█	█	█	█	█	█	█	█
EASE OF LEARNING	█	█	█	█	█	█	█	█	█	█
CHALLENGE	█	█	█	█	█	█	█	█	█	█
VALUE	█	█	█	█	█	█	█	█	█	█
	1	2	3	4	5	6	7	8	9	10
	Poor	Fair	Good	Excellent						

Unlike the endless varieties of maze games, Atari's arcade *Centipede* is not "cute." It is a hard-core gamer's game. So it's not surprising to find an arcade look-alike version for Atari's hard-core gamer's home machine, the 5200. In fact it is so much like the arcade version, someone might put a quarter up on the console to reserve the next turn.

The story behind the action in that game has little to do with what is happening on the screen, so let's just say that you must defend yourself against a variety of insect creatures: centipedes, spiders, fleas, and scorpions. Each creature has its peculiar characteristics, hazards, and point values. It won't take long to learn what they are—provided you get far enough along in the game to even see some of them—but it will be a long time before you have mastered them.

Centipede is a wave-advancement game in that each centipede, winding its way between mushrooms from the top of the screen, represents a wave. To advance

to higher levels you must shoot all the sections of the centipede before you are bitten by any of the creatures (including the centipede if he gets low enough to encounter your on-screen character, which is confined to the bottom quarter of the screen). A pesky spider hovers all around you, trying to bite you, so you've got to keep on the move and not stop too long to take aim at the centipede, the vertically falling flea, or the horizontally roaming scorpion at higher levels. By the way, that scorpion leaves behind poison mushrooms that can send the centipede diving straight down to where your character is. With so much action on the screen, you are not likely to survive long, unless you've had lots of practice.

All is not well, however. This game, like so many others for the 5200, suffers from the impossible non-self-centering joystick. You just can't control the movement of your character the way you'd like to. Of course, the arcade original was designed with a trak ball on the control panel. I have played the 5200-version of *Centipede* with a prototype of Atari's *Trak-Ball* controller accessory, and I must say that it helps immensely. With the *Trak-Ball*, you can take better aim, shoot, and move away to avoid trouble all within a very short instant.

A side note about *Centipede*: Atari also has released a version for the 2600. While the graphics don't come even close to the 5200's, the flavor of the game is definitely like the original. It's easier to reach the higher levels of the game, but the action on screen is among the fastest and most enjoyable I've seen from a 2600 cartridge. **R-E**



HITACHI

NLS Non-Linear Systems

HICKOK

WESTON

DATA PRECISION

KEITHLEY

AWS
A.W. SPERRY INSTRUMENTS INC.

FLUKE

PHILIPS

BK PRECISION

TRIPLETT

Simpson

LEADER

VIZ RBA

**15 MHz DUAL TRACE PORTABLE
W/INTERNAL BATTERY PAK**



**CALL FOR
OUR
SPECIAL
INTRODUCTORY
PRICES**

MODEL
315P

**THE SMALL PORTABLE
WITH BIG FEATURES**

FEATURES

- AC/DC powered • 2mV/Vertical sensitivity • TV (Video) sync filter • 3/4" internal graticule, high brightness CRT • X-Y display mode • Add/Sub mode with ch.2 invert • Automatic and triggered time base • Trace rotation adjustable from front panel • Internal rechargeable pak included • Lightweight 12.1 lbs with battery • Small size (4.4" x 8.8" x 11.7")

SPECIFICATIONS

Vertical System CH. A and CH. B-Deflection Factor, 2mv/div - 10v/div, 12 steps • Frequency Response, DC - 15 MHz (-3 dB) • Risetime, 24 ns • Maximum Input Voltage, 300 V (DC + AC peak) • Input Impedance, 1MΩ ± 5%, 20pF ± 3pF • Display Modes, CH-A, CH-B, DUAL, ADD, CHOP • Internal Horizontal System (Sweep Operation) • Deflection Factor, 0.5μs/div. - 0.5s/div (±5%), 19 steps • Magnification, 5x all ranges • Trigger System - Sources, INT, CH-A, CH-B, EXT • Modes, AUTO, NORMAL • Sensitivity, INT: 1 Div or more, EXT: 1V p-p • Coupling, DC, TV SYNC.

AWS DIGITAL MULTIMETERS

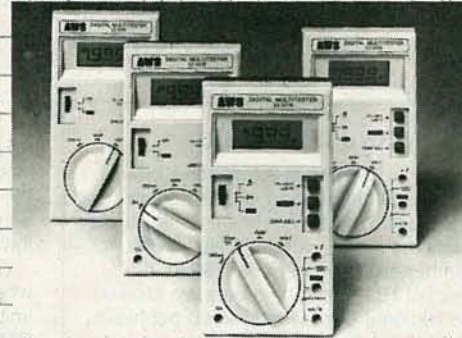

QUANTITIES
LIMITED

- Autoranging on volts and ohms
- Self-contained 10 Amp AC/DC ranges (EZ-6110 & 6220)
- Low power ohm ranges — applied voltage ≤ 0.3V.
- Continuity buzzer (EZ6100 & 6110), 5 settings
- Range hold (EZ6100 & 6110)
- Large 3 1/2 digit LCD display
- 300 hours continuous operation

SPECIFICATIONS

DC Volts: 200 mV, 2 V, 20 V, 200 V, 1000 V
AC Volts: 20 V, 200 V, 200 V, 600 V
Ohms: 200, 2 K, 20 K, 200 K, 2000 K
Low power ohms: 2 K, 20 K, 200 K, 2000 K
AC/DC Amps: 20 mA, 200 mA (EZ-6100)
20 mA, 200 mA, 10 A (EZ-6110)
20 mA (EZ-6200)
200 mA, 10 A (EZ-6220)
Dimensions: 6 2/8" h. x 3.4" w. x 1.1" d.
Weight: 8.8 ozs.

5

**YEAR
WARRANTY**

EZ6110 \$99⁹⁵
reg. \$168.

EZ6220 \$79⁹⁵
reg. \$130.

EZ6100 \$89⁹⁵
reg. \$148.

EZ6200 \$69⁹⁵
reg. \$110.

A.W. SPERRY INSTRUMENTS INC.

FEATURES A FULL 2 YEAR PARTS AND LABOR WARRANTY ON OSCILLOSCOPES.



DIGISNAP DSA-1000
Digital volt—
OHM Snap-Around Ammeter



**Transistor/
Diode Test
Adapter—
HFE-840**



Continuity Test Bugger.
Drop-proof
**AC/DC Multimeter—
Model 316**

**3 1/2 Digit
Handheld Pushbutton Digital
Multimeter—Model 3010**



**TOLL FREE HOT LINE
800-223-0474**

THE TEST EQUIPMENT SPECIALISTS

26 WEST 46th STREET, NEW YORK, N.Y. 10036 212-730-7030

**ADVANCE
ELECTRONICS**

LETTERS

Address your comments to: Letters, **Radio-Electronics**,
200 Park Avenue South, New York, NY 10003

NEW USERS GROUP

A National KAYPRO Users Group, open to all KAYPRO users and other people interested in that machine is being formed, with the National Headquarters in New York.

Membership is \$8 per year (\$6 for the remainder of 1983), and members are entered into a National Database to keep people in touch. They will also receive the quarterly publication, *The Piece of Kayke National Newsletter*, starting with issue #1, dated April 1983. As membership grows, and members submit their own input and applications, it is expected that the newsletter will shift to monthly publication, with corresponding interaction among the local user groups.

The purpose of this Users Group is to unite users, promote interaction, and to supply useful information about the *Kaypro II*—and

future machines in that genre. With approximately 10,000 of the *Kaypro* computers in the field, the pool of *Kaypro* users should double in 1983, with chartered user groups forming in all areas of the country.

Chartered users groups will be recognized when more than six members in close proximity become members.

STEVE BENDER
Users Group #1,
Peoples Computer (of Queens) Kaypro Club,
Box 28360, Queens Village, NY 11428

COMPUTER ARTICLES

I would like to add to the letters that you have been receiving about computer articles or the lack thereof.

For about eight years, I have been receiv-

ing both **Radio-Electronics** and *Popular Electronics*, and during the past year I decided to drop one of the two, because the total of monthly publications was too much to read regularly. But when *Popular Electronics* went over to primarily computer articles, the decision was easy: You won.

Many of us in electronics have to draw the line somewhere. Adding one more hobby or area of specialization each year simply won't work. Considering the cost and vastness of the computer field, several years ago I decided to draw the line there and not try to invest funds and knowledge in computers. Stereo, ham radio, alternate energy, and related experimentation were fully occupying my budget and energy, Photography, computers, and other fascinating fields (even ski-
continued on page 25

2300 MHz VARIABLE DOWNCONVERTER

ANTENNA KIT

\$16.95

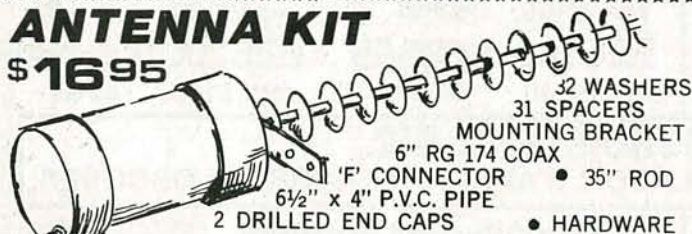

- 32 WASHERS
- 31 SPACERS
- MOUNTING BRACKET
- 6" RG 174 COAX
- 'F' CONNECTOR
- 6 1/2" x 4" P.V.C. PIPE
- 2 DRILLED END CAPS
- 35" ROD
- HARDWARE

POWER SUPPLY KIT

\$16.95



- POWER TRANSFORMER
- COURSE TUNE POT.
- FINE TUNE POT.
- 3 'F' CONNECTORS
- RESISTORS & CAPS
- LED WITH HOLDER
- TERMINAL STRIP

- P.C. BOARD
- RF CHOKE
- KNOB
- WIRE
- 2 SWITCHES
- 4 DIODES
- LM 317 REG.

WOOD GRAIN CABINET WITH SILK
SCREENED front and back \$10.95 Extra
BUILT POWER SUPPLY.....\$34.95

Complete
Down Converter
System
INCLUDES
ANTENNA KIT
POWER SUPPLY KIT
CONVERTER KIT
SPECIAL \$49.95

QUANTITY DISCOUNTS
Any Price in Adv.
10 pcs. 12% off
25 pcs. 18% off
50 pcs. 25% off
100 pcs. 30% off
1000 pcs. 35% off
No Mixing for
Quantity Discount

PARTS

- Converter P.C. Board
Plated through holes
for stability.....\$4.95
- Power Supply
- P.C. Board2.95
- MRF 9012.00
- NEO21354.95
- 2835 Diodes95
- .001 Chip
- Caps. 10/3.95
- Choke Set of 4.....1.95
- LM 317 Regulator 1.25
- 'F' Connectors
- Chassis50
- Wall Transformer
- 12 VAC 700 MA....4.95
- 'U' Bolt95
- BALUN
- 75 to 300 ohm.....1.95
- BALUN
- for rabbit ears....2.95
- *RG 59/U COAX
- WITH CONNECTORS
- FACTORY MADE
- 100 Ft. \$17.50
- 50 Ft. 9.50
- 25 Ft. 5.75
- 3 Ft. 2.50

CONVERTER KIT

\$16.95



P.C. BOARD PRE-DRILLED
SOLDER PLATED WITH
PLATED THROUGH HOLES
FOR A MORE STABLE PICTURE.

- NEW!!
- ... 2137 HOT TRANS...
- 3 MRF 901 TRANSISTOR
- 2 HP 2835 Diodes
- 6 .001 Chip Caps.
- 9 Resistors
- 4 Prewound chokes
- 1 Electrolytic Cap.
- 1 Pre Made Probe

★ WIRED P.C. BOARD TESTED,
READY TO CONNECT TO
CAN WITH PROBE & CABLE
CONNECTOR ATTACHED.
\$24.95

We will tune converter board for \$12.50
trouble shoot
add7.50
trouble shoot
power supply..\$12.50
plus any parts needed.

We will accept telephone orders for Visa & Mastercard
No C.O.D. Orders
To Order Call 800-428-3500 317-291-7262
Complete Kit Weighs 10 pounds. Please add Sufficient Postage
6254 La Pas Trail
Indianapolis, Indiana 46268

ELECTRONIC RAINBOW

YOU SELECT FULL MANUAL
OR FULL AUTORANGING

500 HOUR BATTERY LIFE

HIGH CONTRAST LCD
SHOWS MEASUREMENT
AND FUNCTION

0.25% dc volt
accuracy
Continuity beeper
Diode test
Transient and
overload protected
High energy fuse

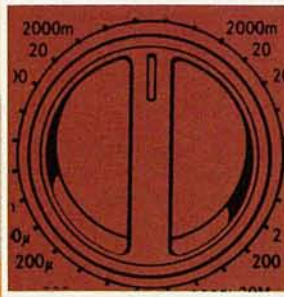

OTHER NEW
DMM MODELS
PRICED
FROM
\$75.00



EASY TO USE... RELIABLE
SINGLE-ROTARY SWITCH
CONTROL

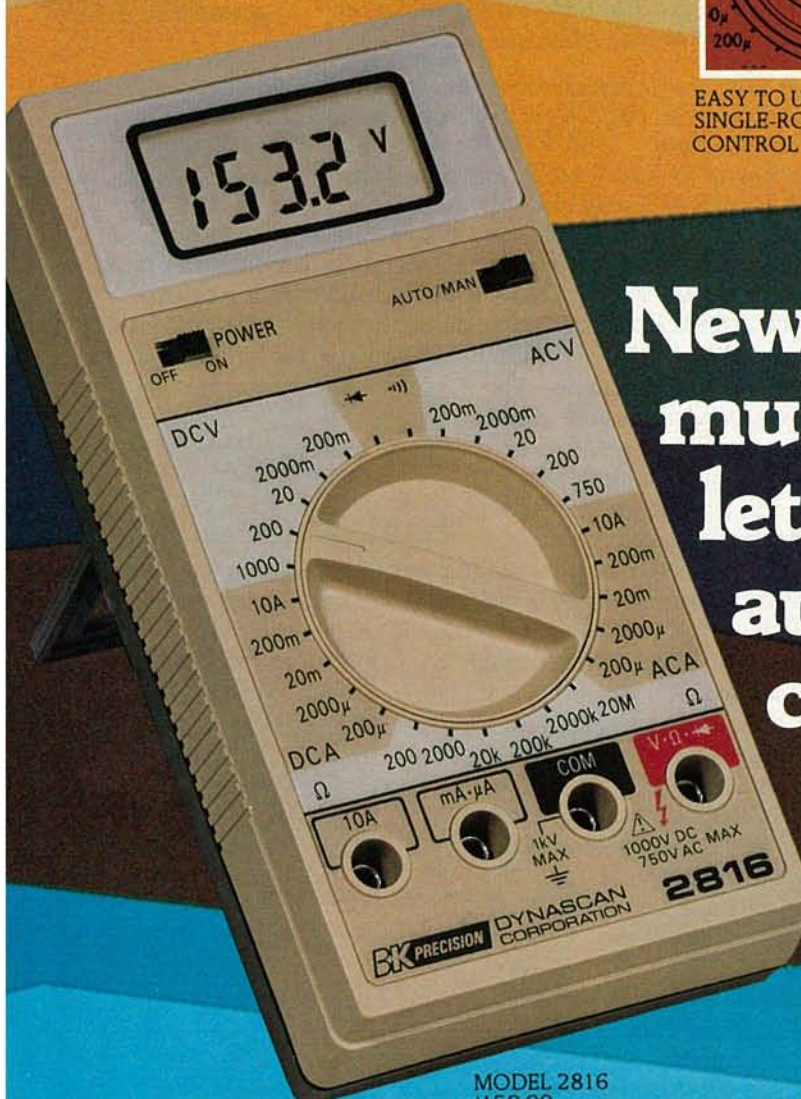

New! A digital multimeter that lets you choose autoranging convenience or manual control

MODEL 2816
\$150.00

To learn more about the 2816
and the complete line of new B&K-PRECISION
DMMs, see your local distributor or call
[1 312 889-9087].

B&K PRECISION DYNASCAN
CORPORATION

6460 West Cortland Street • Chicago, Illinois 60635 • 312/889-9087

International Sales, 6460 W. Cortland St., Chicago, Illinois 60635
• Canadian Sales, Atlas Electronics, Ontario

South and Central American Sales, Empire Exporters, Plainview, NY 11803

CIRCLE 42 ON FREE INFORMATION CARD

TIMEX MAKES THE COMPUTER, BUT WE MAKE IT TICK.

If you own a TS-1000 or ZX-81 computer and want to bring out the power within it, you'll want Memotech. From easier input to high quality output and greater memory, Memotech makes the add-ons you demand. Every Memotech peripheral comes in a black anodized aluminum case and is designed to fit together in "piggy back" fashion enabling you to continue to add on and still keep an integrated system look.

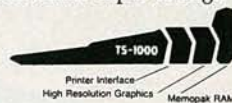

MEMOPAK RAM All Memopak RAMs are directly addressable, user transparent, are neither switched nor paged and no additional power supply is required. You can also choose the Memopak RAM which is just right for your needs. From economy to power. **16K RAM** The Memopak 16K RAM is the most economical way to add memory to your TS-1000. It is fully compatible with the Timex or Memotech 16K RAMs to provide you with up to 32K of RAM. The 16K RAM also offers additional add-on capabilities through its "piggy back" connection. **32K RAM** The 32K Memopak enables you to execute sophisticated programs and store large data bases and like the 16K RAM is fully compatible with Timex's or Memotech's 16K RAMs to give you a full 48K of RAM. **64K RAM** The 64K Memopak is powerful enough to turn your TS-1000 into a computer with capabilities suitable for business and educational use. It accepts such BASIC commands as 10 DIM A (9000). **MEMOCALC** Memocalc, our spreadsheet analysis

software, enables TS-1000 users to perform complex number crunching routines with ease. With the 64K RAM a table of up to 7000 numbers with up to 250 rows or 99 columns can be specified. Quick revisions can be achieved by entering new data to your formula.

MEMOTECH KEYBOARD For ease of operation, the Memotech keyboard is a high quality standard typewriter keyboard, with TS-1000 legends. The keyboard is cable connected to a buffered interface which is housed in a standard Memopak case and plugs directly into the back of the



TS-1000 or other Memopaks. **MEMOPAK HRG** The Memopak High Resolution Graphics, with up to 192 by 248 pixel resolution, enables display of high resolution "arcade game" style graphics through its resident 2K EPROM, programmed with a full range of graphics subroutines.

CENTRONICS PARALLEL AND RS232 INTERFACES

Memotech's Interfaces enable your TS-1000 to use a wide range of compatible printers. The resident software in the units gives the



complete ASCII set of characters. Both Memopak Interfaces provide lower case character capabilities and up to 80 column printing. The RS232 Interface is also compatible with modems and terminals.

SEIKOSHA GP 100A PRINTER The Seikosha GP 100A uses a 5x7 dot matrix printing format with ASCII standard upper and lower case character set. Printing speed is 30 characters/second with a maximum width of 80 characters. The printer uses standard fanfold paper up to 9-1/2 inches wide. The GP 100A is offered as a package including cable and

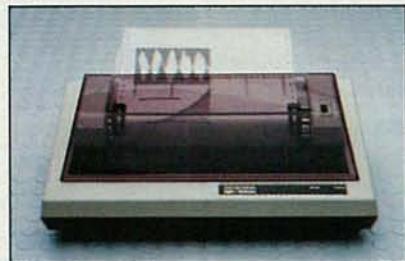

interface. Other printer packages are also available through Memotech.

ORDER AT NO RISK. All Memotech products carry our 10 day money back guarantee. If you're not completely satisfied, return it within ten days and we will give you a full refund. And every Memotech product comes with a six month warranty. Should anything be

defective with your Memotech product, return it to us and we will repair or replace it free of charge. Dealer inquiries welcome. To order any Memotech product use the order coupon or call our toll-free number **800/662-0949.**

TS-1000 is a registered trademark of Timex Corp.

MEMOTECH
CORPORATION

7550 West Yale Avenue, Denver, Colorado 80227, 303/986-1516, TWX 910-320-2917

Mail To: Memotech Corporation, 7550 West Yale Ave., Denver, CO 80227
Code: RE-08

	Price*	Qty.	Total
16K RAM	\$ 49.95		
32K RAM	99.95		
64K RAM	149.95		
Memocalc	49.95		
Keyboard with Interface	99.95		
High Resolution Graphics	99.95		
Centronics Parallel Interface	74.95		
RS232 Interface	99.95		
Printer Cable	19.95		
GP 100A Printer Package**	399.00		
Shipping and Handling	4.95		\$ 4.95
Tax (Colorado residents only)			
TOTAL			\$

*All prices quoted in U.S. dollars. Prices and specifications subject to change without notice.
**Please add an additional \$5.00 for printer shipping charges.
 Check MasterCard Visa

Account No. _____ Exp. _____
Name _____ Phone number _____
Address _____
City _____ State _____ Zip _____

LETTERS

continued from page 22

ing!) had to be passed up, in order for me to succeed with those I had already selected as primary for me.

So, the occasional overview of computer technology and markets in your magazine is welcome as general information, but I would not like to see heavy emphasis on computer circuitry and accessories. The other magazines can serve that need. Finally, we will all have one clear choice in hobby and business electronics reading.

STEPHEN F. WILLEY
Sandpoint, ID

STEREO IMAGE EXPANDER

I am surprised that the two-part article, "Stereo Image Expander," by Joel Cohen (*Radio-Electronics*, June and September 1982) has not generated more comment in your letters department.

I decided to build the image expander, and am I ever glad! Over the years, I have tried to put as little between my ears and the source music as possible, concentrating on obtaining the best speaker systems that I could afford.

Without doubt, next to good speakers, the stereo image expander is the most important component in my system; the improvement in detail and clarity, the general sense of "being there" is just *awesome!* I have used the image expander with Infinity *Monitor IIa's* and with Sander's *Electrostatics*, with excellent results. Naturally, the sonic effect is most realistic with the *Electrostatics*. I can wholeheartedly recommend Mr. Cohen's device to any serious music listener.

One word of caution: In the article, Mr. Cohen explains the importance of carefully determining the optimum speaker placement for best stereo image, even without his device. That very important step must *not* be skipped over if the full potential of the stereo image expander is to be realized.

Thank you for an outstanding construction project and a fine magazine, and don't let the anti-computer people scare you off! I built the Mark 8 successfully in 1974 and enjoy the broad spectrum of your projects.

PAUL FARR
Olivenhain, CA

ACTIVE ANTENNAS

I much appreciate the compact and understandable editing you have done on the VLF Active Antenna articles so far. However, there are some nit-picking problems in labeling and reference to figures in the March 1983 *Radio-Electronics*. Figure 5 on page 67 is not labeled, so the references on page 72 are in error. Figure 5 should be labeled:

- 5a—450kHz lowpass filter
- 5b—100kHz series tuned (Loran-C)
- 5c—60kHz series tuned (WWVB)
- 5d—180 kHz parallel tuned (high Q)
- 5e—180 kHz lowpass filter

Perhaps that could be corrected in a future article or note? There is also a minor error in Figure 3. The arrows pointing to the lines should be labeled f1 - f2 and 2f2 - f1. That is because those lines refer to the magnitude of

the respective 2nd and 3rd order terms at that point, which, by definition, are the terms f1 - f2 and 2f2 - f1 for that example.

I plan to have some circuit boards and the J310 JFET but no other parts available by about April 1st; if any interest develops, I have had correspondence already from some of my friends in the Longwave Club of America regarding the first article in your February 1983 issue. So, thanks again for the editing and effort of your staff here.

R.W. BURHANS
Athens, OH

R/C SERVOS

I just finished reading the article, "How To Interface R/C Servos" in the February 1983 *Radio-Electronics*. It gave me the idea to build a computer-controlled robot arm that can be programmed to move in a precise

fashion pattern.

The application is for a motion-control camera system. My problem is that I need a simple way to program the movement of the servos. The only idea I have is to use the same system that Disney uses on their audio-anamatics. That is: When they want to move an arm, they set it to one extreme of movement and set that position in memory. Then they move it to the other extreme and set that in memory. When they hit the RUN button, the arm moves smoothly from one extreme to the other.

Another way that I've heard it is done is to move the arm through its pattern manually; and the computer "remembers" the pattern. Do you know how either system works and/or an easy way to program a certain pattern in a servo-controlled arm? I would greatly appreciate your help.

RONALD VEDERAME

R-E

STUDIO SPEC™ MAGNIFIER LAMP

AT \$59.95 YOU CAN'T AFFORD TO BE WITHOUT IT



This quality all-metal construction UL recognized lamp uses a standard 22 W fluorescent circline bulb (the bulb is included!). Features of this great buy include a polished, distortion-free glass magnifier (X3); a 4-way, all metal clamp bracket; a full 45" reach. The lamp is available in two colors: Ivory or chocolate brown.

You must agree, it's a steal at only \$59.95 ea. (plus shipping). If you buy 5 or more, it's only \$54.95 (plus shipping). Order No. MX114.

Shipping is only \$5.00 ea. in the continental USA.

SPECIAL BONUS! If you buy one or more of the magnifier lamps, you can get our LTS103 bench lamp for only \$10.95 ea. (plus \$2.80 ea. shipping). The LTS103 is UL listed to 100 W, utilizes a porcelain socket, and includes mounting brackets.

ORA
ELECTRONICS
A DIVISION OF ALLIANCE RESEARCH CORPORATION



To Order Call Toll Free
(800) 423-5336

Calif. Toll Free
(800) 382-3663

Local
(213) 701-5848

"OUR SERVICE MAKES THE DIFFERENCE"

18215 Parthenia Street, Northridge, CA 91325

QTY	ORDER NO.	COLOR	PRICE	SHIPPING	EXT
_____	85-MX114	_____	\$59.95*	\$5.00	_____
_____	85-LTS103	_____	10.95	2.80	_____
_____	85-MX115-FL	_____	5.95	2.00	_____
*Only \$54.95 for 5 or more				TOTAL	_____
Credit Card # _____				Exp. Date _____	
Name (Please print) _____					
Signature _____					

CIRCLE 37 ON FREE INFORMATION CARD

EQUIPMENT REPORTS

Engineering Specialties Model 770 Serial/Parallel Converter

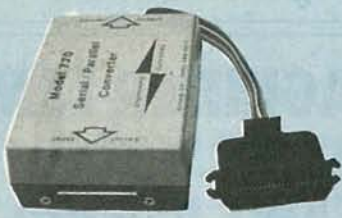

CIRCLE 103 ON FREE INFORMATION CARD

THE MODEL 770 SERIAL/PARALLEL CONVERTER from Engineering Specialties (1501-B Pine St., Oxnard, CA 93030) is a device that matches a computer's serial-

Engineering Specialties 700

OVERALL PRICE	[Bar chart showing price performance]										
EASE OF USE	[Bar chart showing ease of use]										
INSTRUCTION MANUAL	[Bar chart showing instruction manual quality]										
PRICE/VALUE	[Bar chart showing price/value ratio]										
	1	2	3	4	5	6	7	8	9	10	
	Poor			Fair				Good			Excellent

printer output port to a Centronics-type printer.

One of the major problems in upgrading to a better personal-computer system

is that of salvaging the peripherals, in particular the printer. For most of us the printer represented a substantial part of the total cost of our original personal-computer system. Considering how rapidly computer prices have fallen, the price of the printer might now be equal to, or greater than, the cost of the new computer itself; yet more often than not the old printer won't work with the new gear. Many of the most popular early computers were set up to use parallel printers because the lowest-cost printers—the Radio Shack and the Centronics models—were parallel input. Similarly, the parallel version of the Epson MX-80 was priced about \$150 less than the serial model. And let us not forget the IBM Selectric printers retrofitted for personal computers: the majority of them were also parallel "Centronics compatible."

FIRST QUALITY COMPONENTS - NOT MAIL ORDER "SECONDS"

Send for Free Catalog - over 1100 parts.

ARIES ZERO INSERTION FORCE SOCKETS -

cam actuated, true zero insertion - tin plated solder tail pins - capable of being plugged into dip sockets, including wire wrap.

Stock No.	No. of Pins	1-9	10-49	50
11055	24	4.98	\$4.35	\$3.90
11056	28	5.15	4.50	4.05
11057	40	6.81	5.95	5.35
11058	64	12.02	10.50	9.45

IC-KOOLERS from UNITRACK® dissipate over 2 watts of heat from IC's, producing longer life and better performance. Just push IC-Kooler on - heat is collected from top and bottom of IC and dissipated. Won't shake looser!

Stock No.	No. in IC	Price
22225	14	\$.29
22226	18	.29
22227	18	.29
22228	20	.29

WILD ROVER

Touch switch capsule. Operating motion is 005" without the use of a levered arm. Extremely fast on and off with low noise. Normally open - rated 115 VAC, 1.5 amp, 30 milliohm resistance - 61.5 radius by .160 thick.

Stock No.	1-9	10 & Up
12098	\$1.42	\$1.28

60/40 ROSIN CORE SOLDER

Stock No.	Dia.	Length (feet)	Weight (oz.)	Price
50075	062	9	1.5	\$1.16
50076	062	25	4	2.39
50077	062	50	8	4.25
50078	032	33	1.5	1.31
50079	032	80.5	4	2.47
50080	032	175	8	4.57



DIGITAL MULTIMETER
Single rotary switch operation. Large easy to read 5 1/2 digit display. 800 hours operating life with single 9v battery. Seven functions—(DC Volts, DC Amps, Ohms, AC Volts, AC Amps, Diode and Resistor Junction, Audible Continuity Check).

Stock No. 82503 \$79.95 full year warranty

Stock No. 82504 Carrying Case with belt loop \$9.95

TI WIRE WRAP SOCKETS

Tin plated phosphor bronze contact - 3 wrap

Stock No.	No. of Pins	1-99	100-499	500
11301	8	\$.40	\$.36	\$.30
11302	14	.59	.54	.45
11303	16	.64	.58	.48
11304	18	.73	.66	.55
11305	20	.99	.90	.75
11306	22	1.12	1.02	.85
11307	24	1.25	1.14	.95
11308	28	1.52	1.38	1.15
11309	40	2.05	1.86	1.55

TI LOW PROFILE SOCKETS

Tin plated copper alloy 688 contact pins with gas tight seal.

Stock No.	No. of Pins	1-24	25-99	100-999
11201	8	\$.10	\$.09	\$.08
11202	14	.14	.13	.12
11203	16	.18	.15	.14
11204	18	.18	.17	.15
11205	20	.20	.18	.16
11206	22	.22	.20	.18
11207	24	.24	.22	.20
11208	28	.28	.26	.25
11209	40	.40	.37	.33

ELPAC POWER SUPPLIES - DC/DC CONVERTERS

SINTEC Stock No.	ELPAC Stock No.	Input Voltage (VDC)	Output Voltage (VDC)	Output Current (mA)	Dimensions (HxWxD) in Inches	Price
13825	CB3801	3.0-7.0	12±0.6	0-25	.48x.51x3.05	\$ 7.95
13826	CB3811	3.0-7.0	-12±0.6	0-25	.48x.51x3.05	7.95
13827	CB3802	3.0-7.0	15±0.7	0-20	.48x.51x3.05	7.95
13828	CB3812	3.0-7.0	-15±0.7	0-20	.48x.51x3.05	7.95
13829	CB3804	3.0-7.0	28±0.7	0-10	.48x.51x3.05	7.95
13830	CB3814	3.0-7.0	-28±0.7	0-10	.48x.51x3.05	7.95

1.5 W TYPE: 13831 CL3801 4.0-7.0 12±0.6 125 .651x1.2x1.77 \$24.95

13832 CL3811 4.0-7.0 -12±0.6 125 .651x1.2x1.77 24.95

13833 CL3802 4.0-7.0 15±0.7 100 .651x1.2x1.77 24.95

13834 CL3812 4.0-7.0 -15±0.7 100 .651x1.2x1.77 24.95

13835 CL3804 4.0-7.0 28±1.4 50 .651x1.2x1.77 24.95

13836 CL3814 4.0-7.0 -28±1.4 50 .651x1.2x1.77 24.95

13825-1 DATA SHEET FOR DC/DC CONVERTERS 25

13802 SOLV15-5 5 3.0A 4-7/16x4x2 Fixed included \$39.95

13803 SOLV15-12 12 1.5A 4-7/16x4x2 Fixed included 39.95

13804 SOLV15-15 15 1.2A 4-7/16x4x2 Fixed included 39.95

13806 SOLV15-24 24 0.75A 4-7/16x4x2 OVP4 39.95

13808 SOLV30-5 5 6.0A 5-5/8x4-7/8x3-1/16 OVP4 59.95

13809 SOLV30-12 12 4.0A 5-5/8x4-7/8x3-1/16 OVP4 59.95

13810 SOLV30-15 15 3.3A 5-5/8x4-7/8x3-1/16 OVP4 59.95

13812 SOLV30-24 24 3.0A 5-5/8x4-7/8x3-1/16 OVP4 59.95

13802-1 Data Sheet for SOLV Series 25

Special of the Month!

BREAKABLE SOCKET STRIPS WITH MACHINED COLLET PINS!

Strips can be broken by hand into desired number of contact pins. Solder tail version features gold collet/in shell, wire wrap features gold collet/gold shell.

Stock No.	No. of Pins	Style	Sale Price
10240	25	Solder tail	\$1.75
10241	25	Wire wrap	3.25

NEW! Stock No. 10200 \$14.95 (ANTI-STATIC MODEL)

ONE TOOL DOES 8 thru 40 PINS! Stock No. 11059 \$12.95

MODUTEC

Miniclamp AC Volt-Ammeter allows singling one conductor out of many without disarrangement.

ACCESSORY LINE SPLITTER allows fast readings of AC power consumption of plug in equipment without separation of leads. Stock No. 13727 \$9.95

POCKET SIZED BATTERY TESTER for all types of small batteries from 1.35v to 4.5v Stock No. 13733 \$13.95

VOLT-I-CATOR automotive diagnostic meter plugs into lighter socket and indicates battery condition and charging rates. Stock No. 13736 \$15.95

AC VOLTAGE TESTER plugs into any 110v service receptacle to check line voltage over 50-150 VAC Stock No. 13735 \$14.95

VOM-MULTITESTER versatile Volt-Ohm-Milliammeter in small package Stock No. 13729 \$13.95

OK MACHINE AND TOOL

IC INSERTION/EXTRACTION KIT
Includes DIP IC extractors and inserters to accommodate all IC's from 14 to 40 pins. Tools that engage conductive surfaces are CMOS safe and include grounding lugs. Stock No. 13309 \$37.74

SOCKET WRAP ID
DIP socket sized plastic panels with numbered holes in pin locations. Slip onto socket before wire wrapping to identify pins. Also write on them for location, IC part number, function, etc. Simplifies initial wire wrapping, trouble shooting and repair. \$1.82 per pack

IC EXTRACTOR
One-piece, spring steel construction. Will extract all LSI, MSI and SSL devices with 8 to 24 pins. Stock No. 13313 \$2.10

SINTEC co. Drawer Q Milford NJ 08848-9990



TOLL 800-526-5960 FREE in NJ (201) 996-4093

We accept VISA, MC, C.O.D., CHECK, or M.O. INCLUDE SHIPPING CHARGES - 0 to \$100 - \$3.00 \$100 to \$250 - \$4.00 over \$250 - \$5.00

CIRCLE 82 ON FREE INFORMATION CARD

Two facts you'll find hard to believe . . .

1. **This phone, with engineering for the year 2001, is yours right now.**
2. **Your cost is only \$99.95.**

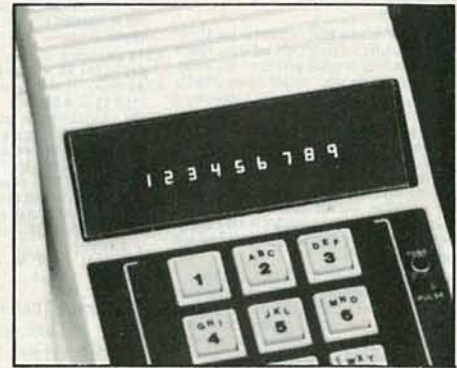

LED Display Shows No. Being Dialed.

The ELECTRONIC SECRETARY-PHONE

\$99.95 complete

SAVE \$20.00! Two for \$179.90
(+ \$2.50 per total order for shipping)

Some of the brightest electronic engineers in the world decided to build a telephone that makes all others obsolete.

This phone would have a **big** memory to remember (and dial with one or two buttons) a lot of phone numbers.

It would handle one or two lines, with a "hold" button, for big-phone performance and convenience.

It would work with rotary pulse or Touchtone®, so you can use it to talk to a computer or to use MCI, Sprint, or any of the tone-code long distance services.

It would display the number being dialed in LED-illuminated figures, to prevent errors even in the dark.

Most of all —

It would be beautiful, a magnificent sleek instrument to enhance any room.

Ladies and gentlemen, we give you...

The Electronic Secretary-Phone

- Takes Two Lines; "Hold" Button
- Remembers 32 Numbers
- Speakerphone with Volume Adjustment
- Sleek Contemporary Styling
- Selectable Pulse or Touchtone Dialing
- LED Display Shows No. Being Dialed

Every other state-of-the-art phone we've seen handles either just one line or (bulkily) five lines.

The ELECTRONIC SECRETARY-PHONE is about half the size of most phones, but its innards are crammed with advanced electronic technology.

What a timesaver! It "remembers" up to 32 numbers! Enter them just once — then call any of them by pushing one or two buttons.

Two-In-One, with "Hold" Button

You control two separate phone lines, which means you can have a true multi-line conference call without involving the phone company.

Talk on Line 1; or put the call on Line 1 on hold while you talk on Line 2; or tie both lines together by depressing both buttons!

Best of all, you can touch one key and you'll have a hands-free speakerphone whose sound fidelity is surprising. Your phone has a volume control, of course.

Before we tell you how little it costs, here a few more timesavers and conveniences built into your Electronic Secretary-Phone:

Elegant, Expensive-Looking, Easy!

We've seen phones you need an engineer's degree to operate. A child will have no trouble putting this wonder-phone through its paces.

You won't dial a wrong number because an LED display shows you, digitally, the number you're calling.

You can call MCI, Sprint, your computer, or anywhere you need the touchtone signal. A touch of your finger switches back and forth from pulse to touchtone.

Automatic redialling of the last number? Of course. No jangling ringer-bell; the ringer is a pleasant electronic tone.

But we think what you'll like most about the Electronic Secretary-Phone is its beauty. If ever a phone could win an award for design, this is it. You'll be proud to have this phone in your home or office.

Get It Far Below Market Place

We originally planned to sell this phone for \$169.95, and it would be a bargain at that price. When we decided to feature it in our catalog, we lowered the price to \$129.95.

Now we've been able to contract for enough of them that you can own an Electronic Secretary-Phone for only \$99.95! At that price, while we have them, you should order two.

Our absolute guarantee means you'll have a month to use this phone and see for yourself that our claims about it are true. Enjoy it!

WE ABSOLUTELY GUARANTEE!

Plug in the ELECTRONIC SECRETARY-PHONE. Use it for up to 30 days. If you decide for any reason you don't want to keep it, return it for a 100% refund.

Order TOLL-FREE

For fast delivery on credit card orders call toll-free 24 hours a day, 7 days a week:

1-800-824-7888

Ask for Operator 551
(in California call: 1-800-852-7777)

Or send check or money order.
Please add indicated shipping cost.

NEW HORIZONS

Dept. RE-8 1 Penn Plaza / Suite 100
New York, NY 10119

NOW!

GET IBM-PC Capacity at a Fraction of IBM's Price!

New NETRONICS 16 Bit EXPLORER 88-PC Kit
Starts at Just \$399.95 - Accepts All IBM Peripherals.

It's true! Now you can enjoy the power of the Intel 8088—the same microprocessor which powers the IBM-PC—and run any program compiled for the IBM-PC...starting at only \$399.95!

Take this easy, low cost way to learn 16-bit technology! Two-board system features:
 1. 8088 mother board with 5-slot expansion bus; accepts any hardware designed for IBM-PC; and
 2. 64K memory board, expandable to 256K; with IBM compatible RS232 communications port.

Any disk-operating system which works on the IBM will work directly on the EXPLORER 88-PC, and all programs compiled for the IBM will run on it.

The system monitor ROM included in the Starter system features a user-friendly operating system that allows easy program generation and debugging. The commands include display/modify memory...display/modify registers...input/output data to I/O ports...block moves...single-step trace mode...go/run with optional breakpoint and register reports...cassette load/save with file labels...plus a complete system test program that tests and reports condition of ROM, RAM, cassette interface, timer, DMA controller, interrupt controller, and the communications port. These test programs not only allow easy debugging of software but they serve as hardware and software learning tools.

The EXPLORER 88-PC STARTER KIT includes a mother board, memory/I/O board, all components needed, sockets for IC's used, one 62-pin bus connector and complete assembly/test instructions. All you need is a soldering iron, solder, a power supply, and a standard RS232 terminal (Netronics has 2 low-cost ones to choose from).
Explorer 88-PC Starter Kit...\$399.95

- + 10.00 p&i
 - (wired & tested, add \$100.00)
 - Extra 62-pin connectors at \$4.25 ea. + 1.00 p&i.
- Use your own terminal with the EXPLORER 88-PC or, if you plan to expand it to be fully IBM compatible, we offer our IBM compatible keyboard and an IBM compatible color graphics board (only available wired and tested).

- IBM compatible keyboard...\$299.95 + 10.00 p&i.
- IBM compatible color board...\$299.95 + 10.00 p&i.
- Additional ROM required...\$35.00.

Set your own pace! Invest and learn, at the rate YOU want! Add to your EXPLORER 88-PC: Deluxe heavy-duty steel cabinet that houses either two 5 1/4" floppies or a 5 1/4" hard disk with one floppy. This cabinet features a brush-finish front panel and a wood-grained sleeve.

- EXPLORER 88-PC Cabinet...\$199.95 + 18.00 p&i.

A heavy-duty open frame power supply with fan that can be used in your own cabinet or installed into the Netronics cabinet is available as follows:

- 10 amp power supply for system + 2 floppies...\$149.95 + 8.00 p&i.
- As above + extra power for 1 hard disk...\$169.95 + 8.00 p&i.
- IBM compatible disk controller board. Controls four 5 1/4" floppy drives (w/2 drive cable). Available—wired and tested only...\$250.00 + 8.00 p&i.
- Monitors and BIOS source listings: available on either disk or hard copy at \$35.00. Please specify format and system required.
- INTEL 8086/8088 user manual...\$15.00 + 1.50 p&i.
- THE 8086 BOOK by RECTOR & ALEX...\$16.00 + 1.50 p&i.

- Special IBM compatible system: with keyboard, color graphics board, floppy disk controller, 64K RAM, cabinet, standard power supply and a single 5 1/4" floppy drive...\$1899.95 + 25.00 p&i.

IBM compatible hard disks, built-in modern board, eeprom burner, print buffer system plus more will be available shortly.

Over 100 EXCLUSIVE Products and Kits—including the 'Speak Easy' universal voice synthesizer, a Diagnostic card with built-in logic probe for the IBM-PC, terminals, monitors, the ELF and EXPLORER 85 computers, and much more, are described in our upcoming catalog. It's yours FREE if you check here



"p&i" stands for "postage and insurance".

CALL TOLL FREE 1-800-243-7428 for Charge Card Orders.
 In Conn., call 203-354-9375, Conn. res. add sales tax.

TO ORDER BY MAIL, CHECK BOXES FOR PRODUCTS DESIRED AND MAIL ENTIRE AD TO:

NETRONICS R&D LTD.
 333 Litchfield Rd., New Milford, CT 06776

Amount enclosed OR Charge my VISA MASTERCARD
 Acct. No. _____ Exp. Date _____
 Signature _____
 PRINT NAME _____
 Address _____ City _____ State _____ Zip _____

Radio-Electronics REPRINT BOOKSTORE

- Build Your Own Satellite TV Receiver \$7.00
- 8-Ball Satellite TV Antenna \$5.00
- Build Your Own Robot \$12.00
- TV Descrambler (January, February 1981) \$3.00
- Radio-Electronics back issues (1983) \$3.00
 (January, February 1983 not available)
 Write in issues desired _____
- Radio-Electronics back issues (1982) \$3.00
 (January 1982 not available)
 Write in issues desired _____
- Radio-Electronics back issues (1981) \$3.50
 (March, December 1981 not available)
 Write in issues desired _____
- Special Projects (Winter 1980) \$4.00
- Special Projects (Spring 1981) \$4.00
- Special Projects #4 (Summer 1982) \$4.00
- Special Projects #5 (Winter 1983) \$3.00
- Special Projects #6 (Spring 1983) \$3.00
- Radio-Electronics Annual 1983 \$2.50
- How to Make PC Boards \$2.00
- All About Kits \$2.00
- Modern Electrics (Vol. 1, #1) \$2.25
 April 1980
- Electro Importing Co. Catalog \$4.95
 (1918) (176 pp)

To order any of the items indicated above, check off the ones you want. Complete the order form below, include your payment, check or money order (DO NOT SEND CASH), and mail to Radio-Electronics, Reprint Department, 200 Park Ave. South, New York, NY 10003. Please allow 4-6 weeks for delivery.

If you need a copy of an article that is in an issue we indicate is unavailable you can order it directly from us. We charge 50¢ per page. Indicate the issue (month & year), pages and article desired. Include payment in full, plus shipping and handling charge.

ARTICLE _____
 MONTH _____ YEAR _____
 PAGES _____
 TOTAL PAGES _____ @ 50¢ each TOTAL PRICE _____

MAIL TO: **Radio-Electronics** 8 83
 Reprint Department, 200 Park Ave. South, New York, NY 10003 **All payments must be in U.S. funds**

Total price of order \$ _____
 Sales Tax (New York State Residents only) \$ _____
 Shipping & Handling (U.S. & Canada only) (Includes FIRST CLASS POSTAGE) \$1.00 per item \$ _____
 All other (\$2.00 per item, sea mail) \$ _____
 (\$4.00 per item, air mail) \$ _____

Total Enclosed \$ _____
 Name _____
 Address _____
 City _____ State _____ Zip _____

Unfortunately, most of the very latest personal computer models come with serial outputs for serial printers; a parallel printer port is often an optional accessory at an extra cost, if it's available at all. Considering that printers have virtually no trade-in value and very little resale value (regardless of what anybody tells you), the best thing you can do is convert your parallel-input printer to a serial-input one with a "serial-to-parallel converter" such as the model 770.

Admittedly, the history of outboard serial-to-parallel converters is not outstanding—many earlier ones worked with only a very few printers. But even more frustrating was the fact that even those converters that worked well with dot-matrix printers could not handle the low effective baud-rate of the inexpensive slow-speed daisy wheel and *Selectric* printers. The result was that those printers would drop every third character or so.

What was happening was that the printer was mechanically incapable of keeping up with flow of data from the computer. What was needed was some type of memory, or buffer, that would store the data until the printer could process it. That need has been answered in this converter; the inclusion of just one byte of memory allows the unit to be used with dot-matrix, slow-speed daisy wheel, and *Selectric* printers.

Description

The model 700 is housed in a plastic cabinet measuring approximately 3/4 x 4 1/4 x 1 1/2 inches. A standard RS-232 serial input D-connector is mounted on one end. A 12-inch ribbon cable terminated in a parallel Centronics-compatible connector comes out the opposite end of the cabinet. If your printer does not use the standard Centronics-type connector, the converter can be ordered without a connector (you supply your own) for \$79.95. With a Centronics connector, it retails for \$89.95.

The converter requires a five-volt, 25-mA power source; that is normally provided by the printer through pin 18 of the Centronics connector. However, not all Centronics-compatible printers provide five-volts at the connector; the Smith-Corona *TP-1*, for example, does not provide an operating voltage of any kind for printer accessories. To handle that kind of power situation the converter is wired to allow the supply voltage to be brought in from the computer through the serial input-connector (more on that shortly). If that is not possible the user must provide a regulated five volts from a small external power-supply.

The serial input connections are standard RS-232: pin 1 is the chassis ground, pin 3 is the signal input from the computer, pin 7 is the logic common (signal

continued on page 31

THE POMONA PROMISE

We provide the design engineer with the best banana plugs and jacks made in this country.
Or anywhere.

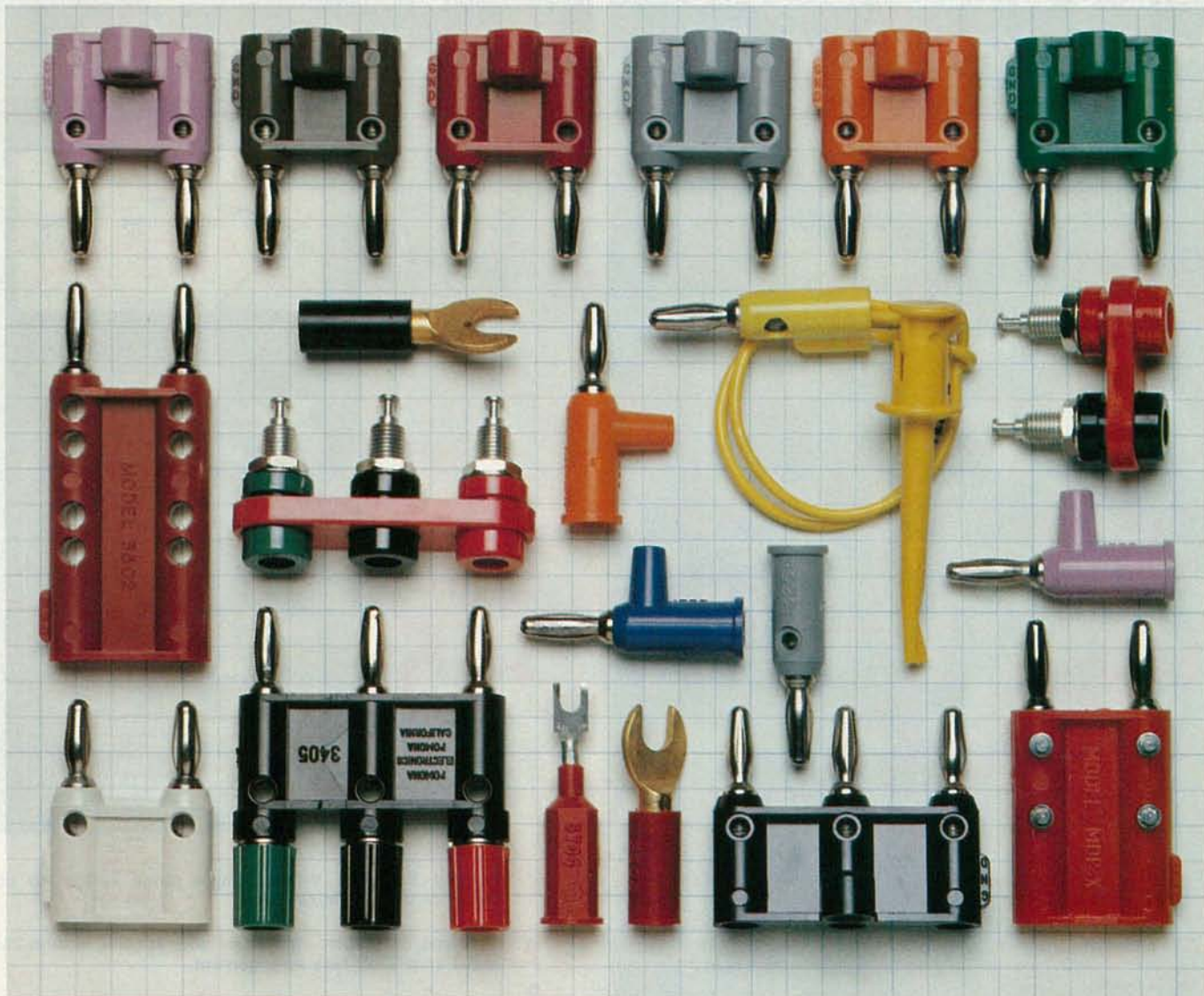

And we've been doing it for a long time. Since 1951 in fact.

That's when we promised there wouldn't be anyone in the world who could design and produce banana plugs and jacks the way we could.

The world agreed.

Naturally, as the years have passed, we've improved upon our original designs. So much so that today, our banana plugs and jacks are out there alone. In their own class.

The same can be said for every other product we design and

produce. And each and every one of them is trusted by the professionals of the electronics industry.

At ITT Pomona Electronics, we know there is no such thing as standing pat. We also know that your needs change and your expectations become greater as the demands become more severe. To this end we will continue to create a better way. A better product.

That's a promise.

All of our products are described and illustrated in our General Catalog, and it's free. Just call (714) 623-3463 or 623-6751.

TWX 910-581-3822. Write to us at ITT Pomona Electronics, a Division of International Telephone and Telegraph Corporation, 1500 E. Ninth St., Pomona, CA 91766.

In Europe: ITT CANNON BELGIUM S.A./N.V. Rue Colonel Bourg Str. 105 Space A (B.3) 1140 Brussels, Belgium. Phone: 02-735-6094.

Our products are available through your favorite electronics parts distributor.

ITT Pomona Electronics

CIRCLE 5 ON FREE INFORMATION CARD

THE performer.

The Triplet Model 3500..
Simple to use—Choose
Auto or Manual ranging.

NEW

only
\$140

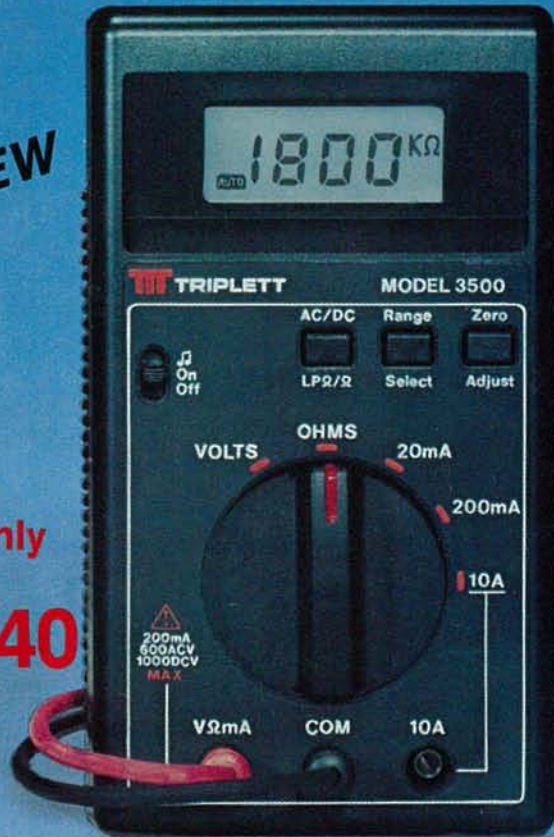

1. Autorange DMM—features simplest and easiest operation with auto or manual range selection plus range annunciators; only two jacks make all measurements except 10A range.
2. Zero Adjust—relative reference feature (offset) works with all DMM functions to display subsequent readings as \pm deviations from the stored input.
3. Overload Protection—with special .3A/250V and 2A/600V fuse arrangement; HI and Low Power ohms on all ranges plus audible continuity tone selection.
4. Manual range readings to 2999.

The new Model 3500 is loaded with features. Choose either the auto range mode or manual mode. Included is a Zero Adjust for offset measurements, overload protection, 10 Amp range, audible continuity tone, readings to 2999 for greater resolution and many more.

For a demonstration, contact your Triplet distributor, Mod Center or representative.

Triplet Corporation, One Triplet Dr., Bluffton, OH 45817. (419) 358-5015; TWX (810) 490-2400.



Triplet performance . .
a tough act to follow

TTT TRIPLETT

CIRCLE 4 ON FREE INFORMATION CARD

THE NEW performer.

The Triplet Model 50...
a High Quality—Low
Cost Versatile VOM

NEW

only
\$55



1. Rugged 12 range V-O-M; single range switch for convenience and minimizes error.
2. Overload Protection—protected with special $\frac{3}{8}$ amp 250V and 3 amp 600V fuse arrangement.
3. Snap off battery compartment access, built in tester stand.

The Model 50 has been especially designed for the hard usage of the industrial and maintenance environment, vocational Tech schools and commercial electrical measurements use.

For a demonstration, contact your Triplet distributor, Mod Center or representative.

Triplet Corporation, One Triplet Dr., Bluffton, OH 45817 (419) 358-5015, TWX (810) 490-2400.



Triplet performance...
a tough act to follow

TTT TRIPLETT

CIRCLE 14 ON FREE INFORMATION CARD

INTRODUCING

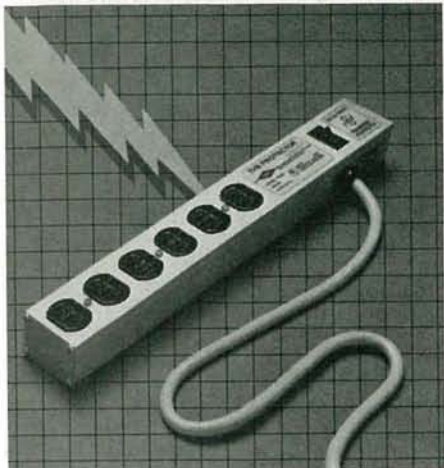

THE PROTECTOR 6000™

TOTAL PROTECTION FOR YOUR SENSITIVE ELECTRONIC EQUIPMENT.

Something that you can't even see may be slowly but surely killing your expensive electronic equipment. It's transient voltage, and it can be fatal to computers, medical equipment, electronic games, videotape recorders, electronic test equipment, electronic cash registers — almost any of today's sophisticated solid state equipment.

THE TRANSIENT VOLTAGE PROBLEM.

Most of this modern electronic equipment uses LSI and MOS semiconductor devices which are extremely sensitive to voltage transient surges or "glitches." In fact, a large percentage of equipment failures can be directly linked to the damaging effects of over-voltage line transients to unprotected, highly fragile components.

THE PROTECTOR 6000™ SOLUTION.

Not to be confused with other transient voltage protection units available today, THE PROTECTOR 6000 uses state-of-the-art solid state components and exclusive circuitry to provide you with complete and total protection from transient voltage surges of up to 6,000 volts. THE PROTECTOR 6000 uses silicon PN junction devices — proven to provide the fastest response to surges! They have a statistical life expectancy of over 20 years. THE PROTECTOR 6000 has a maximum clamping voltage of only 335 volts, well below the voltage rating of other transient protection devices which commonly use much less effective MOV's or gas discharge tubes. It also provides full protection from electro-magnetic and radio frequency interference. The unit operates in both common and differential modes, and is outfitted with a circuit breaker to guard against severe current overloads over 15 amps.

Why take chances with your expensive electronic equipment? For full details contact your local NTE distributor or write:



NEW-TONE ELECTRONICS, INC.
44 Farrand St., Bloomfield, NJ 07003
THE PEOPLE WHO BRING YOU THE TCG
LINE OF SEMICONDUCTORS.

© 1983 New-Tone Electronics, Inc.

EQUIPMENT REPORTS

continued from page 28

ground), and pin 20 is the DTR (Data Terminal Ready) line; it provides a high logic-level to the computer when it is ready to accept data. A wire with a push-in terminal is connected to the internal five-volt supply rail. It can be inserted into the RS-232 connector at whatever pin-location you might select for the input-connector power source.

The only other user-selectable option is selection of the baud rate. Inside the cabinet are pairs of terminal pins that allow you to select rates of 150 to 19.2K baud, in standard steps of $\times 2$. The baud rate that you want is selected simply by installing a push-on jumper across the appropriate pins.

How it works

As we alluded to before, the reason why many serial/parallel converters fail when used with slow-speed printers is that the computer is transmitting the next character before the printer has even returned a "not ready" signal for the first character, or the "not ready" is late on a carriage return or a line feed. The model 770, however, stores the second character and "not-readies" the computer from its one-byte memory, thereby allowing the printer to complete the previous character and get ready for the next. Surprisingly, that scheme works out very well. Even the *TP-1* printer, whose timing diagram indicates a late "not-ready" signal to begin with, works superbly with that unit. Essentially, it's as if the printer port were serial to begin with. We tried the converter with several unusually slow printers and had absolutely no printing problems to as high as 1200 baud, a more or less standard speed for personal computers. In general, the converter worked well in most cases to as high as 4800 baud, but since it was sometimes a little shaky at that speed, especially when used with a retrofitted *Selectric* we have, such operation can not be totally recommended. But we can state with confidence that reliability is 100% to at least 1200 baud.

If there is any complaint with the converter it's the documentation, which does not spell out clearly and distinctly that parallel inputs can be very fussy, requiring that every single return (common) line be tied to the converter's signal ground at the parallel connector. You can spend hours looking for trouble that doesn't exist if a return line isn't connected. Do not assume they are connected inside the printer—that is rarely the case. If the printer doesn't work, or outputs one character and then appears to lock up, check to see if you have tied all the return lines together at the converter's parallel connector.

R-E

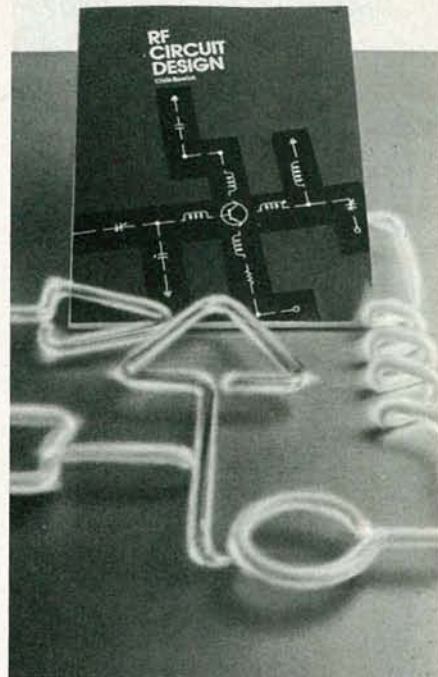

PRACTICAL RF DESIGNS BEGIN WITH SAM'S.

Let Sams' RF CIRCUIT DESIGN help you bridge the gap between RF circuit theory and real-world applications!

Unlike other circuit design books, RF CIRCUIT DESIGN presents a detailed, practical approach to RF circuitry. It's a cookbook for builders, an excellent reference book for designers and engineers, and a complete sourcebook for students.

RF CIRCUIT DESIGN is entirely user-oriented, and includes many hands-on examples that cover such topics as RF amplifiers, filters, oscillators, components and impedance matching networks. It utilizes a minimum of complex math.

Practice Sams practical approach with your own copy of RF CIRCUIT DESIGN, No. 21868 at only \$22.95. To order or get the name of your Sams retailer, call 800-428-3696 or 317-298-5566 and ask for Operator 409.



SAMS BOOKS AND SOFTWARE

HOWARD W. SAMS & CO., INC.
4300 West 62nd Street, P.O. Box 7092
Indianapolis, IN 46206

Offer good in USA only and expires 11/30/83.
Prices subject to change without notice. In
Canada, contact Lenbrook Electronics, Markham,
Ontario L3R 1H2.

AD409

CIRCLE 32 ON FREE INFORMATION CARD

Phillips Model PM 3207 Oscilloscope



CIRCLE 104 ON FREE INFORMATION CARD

Phillips		PM 3207											
OVERALL PRICE													
EASE OF USE													
INSTRUCTION MANUAL													
PRICE/VALUE													
		1	2	3	4	5	6	7	8	9	10		
		Poor			Fair			Good			Excellent		

IT'S BEEN SAID THAT THE OSCILLOSCOPE is one of the most useful, and most often used pieces of equipment on a test bench. We've recently seen one dual-trace scope

that certainly fits that description and is sure to be a welcome addition to any test bench. The scope is the Philips (85 McKee Dr., Mahwah, NJ 07430) model PM 3207.

It boasts a relatively wide 15-MHz bandwidth, making it useful for a wide range of service, educational, and research applications. The unit is lightweight (10.5 pounds) and measures approximately 14.5 x 11.7 x 5 inches excluding the handle and feet. The large bail-type handle also serves as a tilt stand.

Although the unit is certainly portable, there are no provisions for battery operation. The power supply can handle line voltages of 110, 220, or 240 volts AC, plus or minus 10%, at line frequencies between 45 and 66 Hz.

The unit we received came complete with a brief instruction manual, written in seven languages; an extensive service manual, which we will discuss in more depth shortly; and a set of probes including a 1:1 standard probe and a 10:1 attenuator probe. Those probes can handle input voltages of up to 1000 (DC + AC peak).

The capacitance of the 10:1 probe can be varied over a range of 10 to 55 pF by rotating the body. That compensation can be easily done using the PROBE ADJUST

terminal on the front of the scope. That terminal provides a pulse train that is synchronized to the timebase. For a correctly compensated probe, this signal is displayed as a straight line. For an uncompensated probe, the leading edge of the trace bends either up or down.

Scope operation

Using the scope was straightforward and provided few surprises. After a reasonable warm-up period, the brilliant blue trace is rock steady. The CRT graticule is marked off in an 8 x 10 cm-per-division grid.

All the controls are laid out in a logical manner and are grouped more-or-less by function. The first group of controls, at the far left-hand side of the control panel, include the POWER switch, the trace FOCUS, and the trace INTENSITY. There is also a PROBE ADJUST terminal previously mentioned.

Vertical amplifiers

Moving from left to right, the second and third groups of controls are for the A- and B-channel vertical amplifiers, respectively. In each group, the order of controls from top to bottom is trace POSITION, VOLTS/DIV, and the AC/DC switch. The AC/DC switch is used to select the

continued on page 38



A PRACTICAL DIGITAL ELECTRONICS KIT FOR LESS THAN \$40 ! Suitable for Beginners

Meet the challenges of today's incredibly rapid changes in electronics quickly and easily. This innovative kit is as exciting as the circuits you build and explore.

Learn the wonders of digital electronics and see how quickly you are designing your own circuits with the SUPERKIT which contains:

Seven TTL integrated circuits, breadboard, LED's, and all the DIL switches, resistors, capacitors and other components to build interesting digital circuits; plus a very clear and thoroughly tested instruction manual. This course teaches Boolean logic, gating, R-S and J-K flipflops, shift registers ripple counters and half adders. You will learn about fault finding, improvisation and sub-system checking and the manual asks plenty of questions, but never leaves you stuck for an answer. You don't even need a soldering iron! Using the same breadboard you may construct literally millions of different circuits \$39.95
Order one of our written Courses to complement your SUPERKIT.

Digital Computer Logic & Electronics - An introduction to digital electronics designed specifically for the raw beginner. If you're just starting with Digital Electronics this is the Course for you \$13.95
DIGITAL COMPUTER DESIGN - A totally revised and updated Course using the programmed learning system. This book is not intended for beginners but is ideally suited to engineers, technicians and hobbyists who want to know more about digital electronics. \$17.95

TO ORDER BY MAIL

Just send your check or money order to the address below. Make sure you enclose your address and specify which Courses you are ordering. Payment must be in US Dollars drawn on major US Bank. Mass. Residents add 5% sales tax. Company Purchase Orders also accepted.

PHONE ORDERS - FREE

To order by phone call (617) 664-3657 with your credit card information. It won't cost you a dime, because we'll deduct the cost of the call from the cost of the Courses you order.

NO RISK GUARANTEE

There's absolutely no risk to you. If you're not completely satisfied, simply return your order within 30 days. We'll send you a full refund.

AIR MAIL

The prices shown include surface mail postage. For Airmail shipment please write for additional cost, specifying Courses to be ordered.

CAMBRIDGE LEARNING Inc.

P.O. BOX 307, North Reading, MA 01864

CIRCLE 35 ON FREE INFORMATION CARD

SEE YOUR DEALER TODAY

FROM



HERE'S A TIP THAT'S PERFECT!

AM/FM AUTO RADIO AND CB

'Firestik' II

GOLDEN SERIES

BARE-HANDS TUNABLE "NO TOOLS NEEDED" HIGH PERFORMANCE ANTENNAS

ALSO ANTENNAS FOR CORDLESS TELEPHONES MONITOR SCANNERS

Dealer & Distributor Inquiries Invited SEND FOR FREE CATALOG

'Firestik' Antenna Company
2614 East Adams/Phoenix, AZ 85034

Name _____
Street _____
City _____
State _____ Zip _____

Serving the CB and Communications Market Since 1962.

5-YEAR REPLACEMENT WARRANTY

CIRCLE 40 ON FREE INFORMATION CARD

The best 60MHz scope costs only \$1150. It's from Kikusui.



That's right. Only \$1150 for Kikusui's top-of-the-line 5060 model oscilloscope. And we also have four other scopes for as low as \$600 in our new 5000 Series.

Not only that, we're offering a two year warranty on each of them, compared to other big name companies' limited one year warranties.

When it comes to performance, our 5000 Series has the edge over the Tektronix 2200 Series in lab quality, chop frequency, and trigger view. Ours also have more display modes, higher acceleration for better brightness, and sharper focus for better resolution.

Each scope in our 5000 Series is crafted so that it can be used for production, field service, consumer electronics servicing, or even personal use. The 5060 is a 60MHz scope with 3 channels, eight traces, delayed sweep, delay line and alternate sweep, and priced at \$1100. Models 5040 and 5041 are 40MHz, dual channel scopes, featuring peak-to-peak automatic triggering, automatic focus control and a delay line. If you're interested in a 20MHz scope, we have our 5020 and 5021 models with features similar to our 40MHz scopes. Both the 5041 and 5021 also have delayed sweep. Prices at \$920 for the 5041, \$795 for the 5040, \$690 for the 5021 and \$595 for the 5020. So, whatever model suits you best, you can't get a better scope for the money.

Of course, there's a reason we're able to offer these bargains and quality. We're one of the biggest manufacturers of scopes in the world, with over 30 years in the business. Another reason is KIK's nationwide network of lab quality maintenance facilities.

Write us and we'll send complete specifications back to you. Or just take a little time to call us. It's a small price to pay to get big time quality and service.

For sales and technical information
call toll free **800-421-5334**
(in Calif., Alaska, Hawaii 213-515-6432).

Order Toll Free
800-421-5334



17819 Figueroa Street
Gardena, Calif. 90248
TWX 910-346-7648

☛ In Canada call: Interfax Systems, Inc. 514-366-0392



Subsidiary of Kikusui Electronics Corp., 3-1175 Shinmaruko-Higashi, Nakaharu-Ku, Kawasaki City, Japan (044) 411-0111

CIRCLE 48 ON FREE INFORMATION CARD

If you have put off learning more electronics for any of these reasons, act now!

- I don't have the time.
- High school was hard for me and electronics sounds like it may be hard to learn.
- I can't afford any more education.
- I have a family now.
- I'm here. You're there. I've never learned that way before. I'm not sure it will work for me.

Read the opposite page and see how you can get started today!

Be honest with yourself. Are the reasons really excuses? You already know enough about electronics to be interested in reading this magazine. So why not learn more? If you need encouragement, read on and see how excuses can be turned into results.

You don't have the time. Be realistic. All you have in life is a period of time. Use it. Try to know more tomorrow than you do today. That's the proven way to success. CIE studies require just about 12 hours of your time a week, two hours a day. You probably do have the time.

Electronics sounds like it may be hard to learn. You already know something about electronics or you wouldn't be reading this. Now, build on that. CIE Auto-Programmed® Lessons help you learn. Topics are presented in simple, logical sequence. All text is clear and concise for quick, easy understanding. You learn step by step, at your own pace. No classes to attend. Nobody pressures you. You can learn.

You can't afford any more education. Actually, you can't afford NOT to gain the skills that can put you ahead of the others. You know what inflation is doing to you now. Education—learning a skill—is an inflation-fighter that can be yours. If you are not able to pay full tuition now, CIE will lend you funds on a monthly payment plan.

You have a family now. All the more reason why you have the responsibility to advance yourself. For the sake of your family. Do you want them to have what you had or have more than you had? The choice is yours. Electronics is a rewarding career choice. CIE can help you to get started on that career.

You're there. We're here. How does CIE help you learn? First, we want you to succeed. You may study at home, but you are not alone. When you have a question about a lesson, a postage stamp gets you your answer fast. You may find this even better than having a classroom teacher. CIE understands people need to learn at their own pace. When CIE receives your completed lesson before noon any day of the week, it will be graded and mailed back the same day with appropriate instructional help. Your satisfaction with your progress comes by return mail. That's how CIE helps you learn.

NOW, IF YOU AGREE CIE TRAINING CAN WORK FOR YOU, HOW ELSE CAN CIE HELP YOU?

Cleveland Institute of Electronics is the largest independent home study school in the world that specializes exclusively in electronics. Although "big" does not always mean "best," it is evidence that CIE is a strong, successful institution with the people and resources to help you succeed.

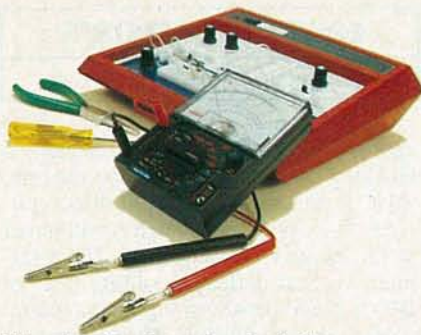

Step-by-step learning includes "hands-on" training.

The kind of professional you want to be needs more than theory. That's why some of our courses include the Personal Training Laboratory, which helps you put lesson theory into actual practice. Other courses train you to use tools of the trade such as a 5MHz triggered-sweep, solid-state oscilloscope you build yourself—and use to practice troubleshooting. Or a Digital Learning Laboratory to let you apply the digital theory that's essential today for anyone who wants to keep pace with electronics in the eighties.



Your FCC License can impress employers.

For some electronics jobs, you must have your FCC License. For others, employers usually consider it a mark in your favor. Either way, your License is government-certified proof of your knowledge and skills. More than half of CIE's courses prepare you to pass this exam. Surveys show that some 80% of CIE graduates who take the exam are successful.

Find out more! Today. Now.

There's a card with this ad. Fill it in and return. If some other ambitious person has already removed it, use the coupon.

You'll get a copy of CIE's free school catalog, along with a complete package of personal home study information.

For your convenience, we'll try to arrange for a CIE representative to contact you to answer any questions you may have.

If you are serious about a rewarding career, about learning electronics or building on your present skills, your best bet is to go with the electronics specialists—CIE. Mail the card or coupon today or write CIE (please mention the name and date of this magazine), 1776 East 17th Street, Cleveland, Ohio 44114.

This could be the best decision you've made all year.

Associate Degree

Now, CIE offers an Associate in Applied Science Degree in Electronics Engineering Technology. In fact, all or most of every CIE Career Course is directly creditable towards the Associate Degree.

"If you're going to learn electronics, you might as well learn it right?"

*John Cunningham
Senior Technical Director*



CIE Cleveland Institute of Electronics, Inc.

1776 East 17th Street, Cleveland, Ohio 44114
Accredited Member National Home Study Council

YES... I want to learn from the specialists in electronics—CIE. Send me my FREE CIE school catalog...including details about the Associate Degree program...plus my FREE package of home study information.

Print Name _____

Address _____ Apt. _____

City _____

State _____ Zip _____

Age _____ Phone (area code) _____

Check box for G.I. Bill bulletin on Educational Benefits: Veteran Active Duty

MAIL TODAY!

RE-66

Digital Features.



Analog Prices.

Now you can get all the measurement capability you've been looking for in a digital multimeter for the price of an analog.

Priced as low as \$59.95, the Circuitmate™ Series DMMs from Beckman offer a superior combination of standard features including:

- DC + AC Volts
- DC + AC Amps
- Resistance
- Diode Test
- 0.8% or 0.5% DC Accuracy (depending on model)
- Single Rotary Selection Switch

Depending on the model you choose—you can enjoy the added capability and convenience of 10 Amps AC + DC, audible continuity checking, hFE testing, capacitance and conductance capability.

Get your hands on a Circuitmate™ DMM today. For the dealer nearest you, write or call Beckman Instruments, Inc., Instrumentation Products, 2500 Harbor Blvd., Fullerton, CA 92634, (714) 993-8803.

BECKMAN

CIRCLE 78 ON FREE INFORMATION CARD

EQUIPMENT REPORTS

continued from page 32

appropriate input. If AC is selected, a blocking capacitor is inserted in the line; if DC is selected, the signal is direct coupled. The VOLTS/DIV switch is calibrated in the usual 1-2-5 sequence. The minimum vertical deflection setting (AC or DC) is 5 mV-per-division; the maximum is 10 volts-per-division. The accuracy is $\pm 5\%$.

There are also two additional switches located between the second and third groups of controls. When the one labeled \pm is in the + position, operation is normal. When it is in the - position, an inverted channel-B signal is displayed. The switch labeled A + B/ADD is used to select between displaying either both channels (chopped when the timebase is in the millisecond range; alternated when it is in the microsecond range), or the sum of the channels displayed. If the scope is set to display an inverted channel B as previously discussed, the add mode is especially useful in finding the difference between two signals.

Timebase and trigger controls

The fourth and last group of controls deals with the triggering, timebase, and

X-position of the trace. Going again from top to bottom, left to right, those controls are X-POSITION, LEVEL, μ S/MS, TIME/DIV, 1X/5X, and four triggering-control slide switches, A/B, \pm , INT/EXT, and AC/TV.

The level switch is used to set the point on the input signal at which the trigger signal is derived. The sensitivity for an internally derived signal is 0.75 division at 100 kHz; for an external trigger signal, it is 0.75 volts at 100 kHz.

Looking at the TIME/DIV switch, the time coefficients range from 0.2 seconds-per-division to 0.5 microseconds-per-division. The switch is calibrated in the usual 1-2-5 sequence with an accuracy of $\pm 5\%$. Using the 5X position on the 1X/5X switch extends the maximum sweep rate to 100 nanoseconds; it also increases the error by $\pm 2\%$.

One of the positions on the TIME/DIV switch is labeled X VIA A. Instead of a separate external horizontal input, when the switch is set to that position, the horizontal deflection is determined by the input to channel A.

Of the triggering control switches, the one labeled A/B selects which channel's signal is to be used for triggering. The \pm switch is used to select between triggering on the positive- or negative-going slope. The INT/EXT switch is used to select between trigger-signal sources. In the INT position, the signal is derived from either channel A or B; in the EXT it is derived from an external signal applied to a BNC connector. The scope is rated to accept external trigger signals of up to 400 volts (DC + AC peak). Finally, the AC/TV switch is used to select between normal triggering and TV-line or -frame synchronization.

Manuals

As mentioned previously, the sample we received came with two manuals. The operating manual was very brief and a bit disappointing. The service manual was quite a different story, however; it contains a wealth of information. Among other things it includes a complete circuit description including block and simplified schematic diagrams. There is, of course, a complete schematic. Also provided is complete testing, calibration, and maintenance information, as well as PC-board layouts and parts lists for the unit. There's even a comprehensive, easy-to-use listing of test points, with an accompanying location chart, for simplified troubleshooting. Rounding out the manual is a listing of Philips sales and service centers world-wide. It would make life so much easier if all pieces of electronics test equipment were so well documented.

The PM 3207 appears to benefit from a well thought-out, well-executed design. It has a suggested retail price of \$725, and all-in-all this scope looks like a real winner.

R-E

continued on page 40

If you need

QUARTZ CRYSTALS

—one or hundreds—

YOU NEED JAN

- high stability
- prompt service
- cost savings

- General Communication
- Industry
- Marine VHF
- Scanners
- Amateur Bands
- CB Standard
- CB Special
- Microprocessor

JAN CRYSTALS

Call or Write
JAN CRYSTALS

P.O. Box 06017
Fl. Myers, Fl. 33906-6017
All Phones (813) 936-2397

CIRCLE 54 ON FREE INFORMATION CARD

EXTRA EXTRA VALUES

MONEY SAVING SALES SPECIALS



Cobra® TELEPHONES

PORTABLE CORDLESS EXTENSION TELEPHONE

• Exclusive clear call selector allows optimum voice clarity within operation range

89⁹⁵ ea.
MODEL CP205S

• Portable handset allows you to place or answer calls up to 600 feet from base unit... inside or outside.



CORDLESS TELEPHONE-CLOCK RADIO

119⁹⁵ ea. MODEL RP-740S

• For inside or outside your house (up to 100 ft.)
• Automatically redials last telephone number called.
• Mute button for privacy.

AM-FM ELECTRONIC DIGITAL CLOCK RADIO FEATURE: • Large LED time display
• Hi-Lo dimmer switch • Snooze alarm • Walnut styling • Slide rule dial indicator.



CORDLESS TELEPHONE

88⁰⁰ ea.
MODEL CP-110S

• Mute button on handset allows you to talk to someone in room without party on line listening to conversation. Remote Rechargeability • Works up to 600* feet from base unit.



CORDLESS SPEAKERPHONE

149⁹⁵ ea.
MODEL CP-130S

• Speakerphone is built into base unit. Allows entire family to speak and listen without passing around the handset. You get Hands Free Conversation • 9 Number Automatic Dialer • Last number redial • 2-Way Intercom with Hold • Works Up to 600* feet • Exclusive Clear Call Selector



PAIR-O-PHONES: COMPLETE PHONE SYSTEM

165⁰⁰ ea. MODEL CP-140S

• 1 Cordless Telephone with memory that stores and automatically dials up to 9 numbers plus last number redial • 2-Way intercom that allows paging from remote handset and base, plus hold • 1-Standard Telephone with 10 foot cord and RJ-11 modular plug, mute button and last number redial button • 1-Telephone Wall Holster • 1-Remote Charger.



Cobra® CB RADIOS & ACCESSORIES

AM CB RADIOS

119⁹⁵ ea.
MODEL 29LTD

"The Truckers Choice" with an instant emergency channel 9 switch • Delivers maximum power output, 100 per cent modulation and fine receiver sensitivity. Features: SWR bridge and antenna warning indicator.



SUPER HETERODYNE RADAR DETECTOR

139⁹⁵ ea.
MODEL RD-4000

Dual Band Super Sensitivity/Dual Alarm... Audible and Visual with exclusive SIGNAL

ELIMINATES FALSE ALARMS • Responds to X and K band Speed radar frequencies. The only one approved by the FCC.



SSB MOBILE

179⁹⁵ ea.
MODEL 148GTL

Precision AM/SSB mobile unit for CB. Features: DynaMike, Volume, ON/OFF control. Squelch, RF gain, SWR CAL control, Voice Lock, S/RF/CAL/SWR switch, LSB/AM/USB mode switch, switchable automatic noise limiting and noise blanking, CB/PA switch and much more.



40-CHANNEL CB 2-WAY MINI-MOBILE RADIO

39⁹⁵ ea.
MODEL 19XS

• Combination Squelch/PA/CB Control
• ANL Switch automatically reduces the high-pitched noises • S/RF PWR Meter
• Off/On/Volume • PA



S.O.S. 40 CHANNEL EMERGENCY 2-WAY RADIO

55⁰⁰ ea.
MODEL 39LTD

Needs no installation. Simply plug into cigarette lighter. Features a built-in microphone, LED channel display, emergency channel 9 indicator plug a host of others.



FORDHAM

260 Motor Parkway, Hauppauge, N.Y. 11783

■ Master Charge
■ VISA ■ COD
■ Money Order
■ Check

N.Y. State residents add appropriate sales tax.

COD's extra (required 25% deposit)

ADD FOR SHIPPING AND INSURANCE	
\$250.00	\$4.50
\$251.00 to 500.00	\$6.50
501.00 to 750.00	8.50
751.00 to 1000.00	12.50
over 1000.00	15.00

TOLL FREE
(800) 645-9518
in N.Y. State call 800-832-1446

Guitar Tuner \$34.95

easy to build kit
\$49.95
assembled

Accurate

Easy to use

Unbelievably inexpensive



... that's our new BANANA quartz guitar tuner kit. Thru-jacks let you tune electric guitars without unplugging. Acoustic guitars tune with built in condenser mic. Internal speaker produces by-ear tones if you want them.

Two easy to use tuning indicators — a meter to indicate pitch deviations up to 1/2 semi-tone and LED go-no-go indicators, both with quartz accuracy.

Runs for months on a single AA penlight and one 9v. battery. Easy to assemble kit with step-by-step instructions.

No. 9700 only \$34.95 plus \$2.00 shipping.
No. 9700A Assembled & Tested... \$49.95
Order yours today...

CHARGE TO VISA OR MC TOLL-FREE
1-800-654-8657 9AM to 5PM CST MON-FRI

Ask for your free PAIA Kit catalog
Direct mail orders and inquiries to: Dept. 8R

PAIA Electronics, Inc.

1020 W. Wilshire, Oklahoma City, OK 73116 - (405)843-9626

CIRCLE 52 ON FREE INFORMATION CARD

Global Specialties Model 3002 Capacitance Meter

WHEN WE ARE EVALUATING TEST EQUIPMENT, we are always on the lookout for that rare instrument that is both easy to use and useful. One such instrument is the Global Specialties (70 Fulton Terrace, PO Box 1942, New Haven, CT 06509) model 3002 autoranging digital capacitance-meter.

That hand-held instrument is no bigger than a VOM, yet is capable of performing just about any capacitance measurement you might need. It boasts a tremendous range, from 1.0 pF up to 19.99 mF (that's millifarads—one thousand microfarads), and a very high accuracy. (The accuracy is stated to be 0.2% on the lowest range (1 to 199 pF,) and 1.0% on all others.)

The front panel is simplicity itself. It features a nice, large, 3 1/2-digit readout; LED range-indicators are located just to the right of that display. Below the display are the ON/OFF switch and the ZERO-ADJUST control. The jacks for the test leads, and contacts to which a capacitor can be directly connected, are at the bottom.

As simple as that panel is, using the unit is even simpler. There are just two steps; turn on the unit, and connect the capacitor. The meter does the rest; there's no range switch, or anything else, to set.

CIRCLE 105 ON FREE INFORMATION CARD

Global Specialties		3002											
OVERALL PRICE													
EASE OF USE													
INSTRUCTION MANUAL													
PRICE/VALUE													
		1	2	3	4	5	6	7	8	9	10		
		Poor			Fair			Good			Excellent		

The capacitance is read directly from the LCD display, and the LED range-indicators show the units.

Capacitors can be connected to the device in one of two ways; either through test leads that plug into the front-panel jacks, or directly to the front-panel contacts. Those front-panel contacts can save a great deal of time in situations where large numbers of capacitors must be checked. The only care that must be taken is to be sure to observe the polarity when checking electrolytics. If a polarized capacitor is reversed, the display will read "000.0." If you are unsure of the polarity, which is quite possible when dealing with the small low-voltage types, just hook them up and the readout will tell you whether you are right. Leaky capacitors can be spotted because their readings will be far higher than their rated capacitances. Be aware, however, that the capacitance of electrolytics can vary at least ±20% from their rating.

Using the meter

The circuitry that makes all this possible is ingenious; Global uses a dual-slope integrator like those found in many VOM's. A very precise reference voltage is applied to the capacitor, the time needed to charge it is "counted," and that



FREE
10
L.E.D.s
A \$2.00 VALUE

You can now receive ten prime T-1¾ or T-1 red LEDs absolutely free. It is our way of introducing you to the quality parts we offer.

ETRONIX

14803 N.E. 40th Dept. RE1102
Redmond, WA 98052

Yes, Please send me 10 Free LEDs, plus your brochures on additional products available. I prefer T-1 T-1¾.

NAME _____
ADDRESS _____
CITY _____ ST _____ ZIP _____

Please include \$1.00 to help cover postage and handling.

CIRCLE 10 ON FREE INFORMATION CARD

CABLE TV

CONVERTERS DESCRAMBLERS

Largest Selection
of Equipment Available
\$ Buy Warehouse Direct & Save \$



36 channel
converter
\$45⁹⁵

36 channel
wired remote
converter
only
\$88⁹⁵



Send \$2 for complete catalog
of converters and unscramblers

Quantity Discounts • Visa • Master Charge
Add 5% shipping—Mich. residents add 4% sales tax

C&D Electronics, Inc.
P.O. Box 21, Jenison, MI 49428
(616) 669-2440

Slashes Fordham Lowers Prices on B&K PRECISION Test Equipment

Now Fordham is passing on to customers the hugest savings possible on test instruments. To help celebrate the opening of our new 40,000 square foot facility on Long Island, we've purchased an extra large inventory of B&K Precision products.

We're offering the quality of name brand products and the benefits of our volume purchasing power. While supplies last we guarantee these unbelievably low prices.

3 1/2 Digit LCD Autoranging DMM

Model 2845
Reg. \$175.00

Now **\$79⁹⁵** each

B&K PRECISION

- Fully automatic, auto-ranges on all functions.
- Range lock holds any range.
- 0.1% accuracy.
- Fast reading.
- 0.5" LCD display.
- Autozeroing.
- Autopolarity on all ranges.
- Audible continuity indicator.
- Varistor and fuse over-load protection.
- RF shielded.
- Meets UL 1244 safety standards.



8-Trace, 4 Channel 100 MHz Dual Time Base Scope

Model 1500

Reg. \$2575.00

Now **\$1489⁰⁰** each

B&K

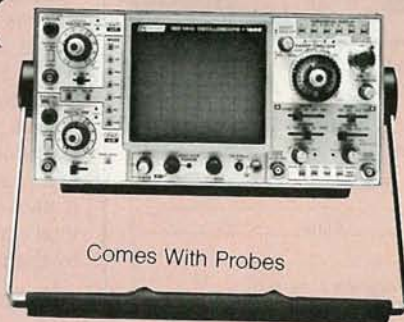

Comes With Probes

- 100 MHz response, 3.5nS rise time • 2nS/div. sweep rate with 10X magnifier • Trigger views or four separate inputs • Dual time base • 1 M ohm inputs or 50 ohm inputs • 1 mV/div sensitivity to 100 MHz • CH 1 frequency counter output • Delayed sweep, 20 nS to 0.5 seconds • Alternate timebase
- Switching power supply • Selectable chop frequencies • Voltage and current probe calibrators.

Low Distortion Function Generator

Model 3010
Reg. \$220.00

Now **\$187⁵⁰** each



- Generates sine, square and triangle waveforms • Variable amplitude and fixed TTL squarewave outputs • 0.1 Hz to 1 MHz in six ranges • Typical sine wave distortion under 0.5% from 0.1 Hz to 100 kHz • Variable DC offset for engineering applications
- VCO external input for sweep-frequency tests.

Dynapeak Transistor Tester

Model 520B
Reg. \$239.00

Now **\$199⁷⁵** each



- Fast testing • Hi/Lo drive • Works in-circuit when others won't • Identifies leads of bipolars and FET's • Random lead connection • Audible test OK 'beep'
- Automatic NPN/PNP and Si/Ge identification.

CRT Restorer/Analyzer

Model 467
Reg. \$495.00

Now **\$420⁷⁵** each



- Restores color and b/w picture tubes like new! Uses the most powerful restoration method known with minimal danger to the CRT • Exclusive multiplex test technique tests all three guns of color CRT's simultaneously under actual operating conditions, even CRT's with common G1 and G2, with real dynamic tests • Instant, automatic tracking.

FOR ORDERING OR PRICING ON OTHER TEST EQUIPMENT

Call Toll Free
(800) 645-9518

N.Y.S. (800)832-1446

FORDHAM

260 Motor Parkway, Hauppauge, N.Y. 11788



■ Master Charge ■ VISA ■ COD
■ Money Order ■ Check
\$50.00 minimum order
COD's extra (required 25% deposit)

N.Y. State residents add appropriate sales tax.

ADD FOR SHIPPING AND INSURANCE	
\$250.00 \$4.50
\$251.00 to 500.00 6.50
\$501.00 to 750.00 8.50
\$751.00 to 1000.00 12.50
over 1000.00 15.00

AUGUST 1983

41

YOUR EXCITING NEW HOBBY!

- Enjoy fantastic savings by assembling your own organ or piano.
- It's easy. No technical knowledge required.
- Just follow our clear, pictured instructions.
- Choose from many models from portables to consoles.
- Ask about our interest-free installment plan.

WERSI

ORGAN & PIANO KITS

For Free Information Pack M40

Call Toll Free
800 233 3865
In PA 717 299 4327

or send
coupon
below



WERSI Dept. M40 P.O. Box 5318
Lancaster, PA 17601

- Free Info. Pack: Organ Piano
 Catalog & Demo Record (enclose \$6)

Name _____

Address _____

City _____ State _____ Zip _____

Phone (____) _____

Rep inquiries invited

CIRCLE 95 ON FREE INFORMATION CARD

ANYONE CAN!

CUSTOM BUILD YOUR OWN ...

ONLY! \$49.95

ASSEMBLY REQUIRED

FOOT SWITCH

8-CHANNEL METER

... ELECTRONIC PANELS OR METAL BOXES WITH THIS EASY TO OPERATE SHEET METAL BENDER, EASILY BENDS MOST ANY LIGHT GAUGE SHEET METAL UP TO AN 18" WIDTH. ALSO INCLUDED, FREE WITH PURCHASE, ARE EASY TO FOLLOW PLANS TO CONSTRUCT THE 3 ENCLOSURES SHOWN.

PLEASE SEND CASHIER'S CHECK OR MONEY ORDER AND RETURN ADDRESS PLUS \$4.50 SHIPPING AND HANDLING, MS. RES. ADD 5% SALES TAX. (VISA & MASTERCARD ONLY. INCLUDE, ACCT.# & EXPIRATION DATE, OR CALL DIRECT, ANY TIME 1-601-957-3407.)

MAIL ORDERS TO: HANIDY MAN, INC., P.O. BOX 12284 JACKSON, MS. 39211

count is fed to an A/D converter. The result is displayed on the readout.

For small capacitors, that doesn't take much time. For larger ones, the instrument should be allowed to run through about three count-cycles for greatest accuracy, but even that takes only a few seconds. The ZERO ADJUST control can be used to cancel out stray capacitances in the instrument, as well as in the test set-up, for greater accuracy when checking very small values.

Power is supplied by six "AA" cells, preferably nickel-cadmium, although the alkaline type can be used. The unit can also be powered from the AC line through the use of the MMA-2 AC adapter/charger, or from your car battery using a cigarette-lighter plug. A selector switch inside the battery compartment sets the circuit for the battery type; you can charge nickel-cadmium cells using the AC adapter, but not alkaline cells. Current consumption is low, about 75 mA, and the batteries will last for 16 hours of continuous use. If the LO BAT annunciator shows up on the display, the voltage is below 5.9 volts, and the batteries should be recharged or replaced.

Lots of tricks can be done with the instrument. You can measure the length of a coax cable if the capacitance per foot is known. That's done by measuring the total capacitance of the cable; divide that by the per-foot rating and you have your

length. You can also find an open conductor in a multi-conductor cable; that's one of the toughest jobs around! Just make sure the opposite end of the cable is open and measure the capacitance of each wire. When you find the one that's much lower, you've got it. With its high sensitivity, you can even use the meter to read the capacitance between two conductors on a PC board! That could be invaluable for those who design or make their own.

There is one precaution that should be taken before measuring a capacitor: The capacitor should be discharged first, especially if it's a large-value electrolytic. There is adequate protection in the form of a fuse and clamp diodes, but it's always easier to discharge the capacitor than to replace the fuse.

In general, then, this is quite a handy and accurate little instrument that is very easy to use. It comes with a good instruction manual that covers everything you need to know about the device including applications and theory. The model 3002 sells for \$210.00. **R-E**

ACTIVE RECEIVING ANTENNA

Gives excellent reception, 50 KHz to 30 MHz.

New MFJ-1024 Active Receiving Antenna mounts outdoors away from electrical noise for maximum signal.

Gives excellent reception of 50 KHz to 30 MHz signals. Equivalent to wire hundreds of feet long. Use any SWL, MW, BCB, VLF or Ham receiver.

High dynamic range RF amplifier. 54 in. whip. 50 foot coax. 20 dB attenuator prevents receiver overload. Switch between two receivers. Select auxiliary or active antenna. Gain control. "ON" LED. Remote unit, 3x2x4 in. Control, 6x2x5 in. 12 VDC or 110 VAC with optional adapter, MFJ-1312, \$9.95.



\$129.95
(+\$4.00 shipping)

Order from MFJ and try it. If not delighted, return within 30 days for refund (less shipping). One year unconditional guarantee. Order today. Call TOLL FREE 800-647-1800. Charge VISA, MC. Or mail check, money order. Write for free catalog. Over 100 products.

CALL TOLL FREE 800-647-1800

Call 601-323-5869 in Miss., outside continental USA, tech/order/repair info. TELEX 53-4590.

MFJ ENTERPRISES, INCORPORATED

Box 494, Mississippi State, MS 39762

CIRCLE 66 ON FREE INFORMATION CARD

Heath Semiconductor Devices Course



CIRCLE 106 ON FREE INFORMATION CARD

Heath Semiconductor Course											
OVERALL PRICE											
EASE OF USE											
INSTRUCTION MANUAL											
PRICE/VALUE											
		1	2	3	4	5	6	7	8	9	10
	Poor		Fair		Good		Excellent				

THE HEATH COMPANY, LONG A MANUFACTURER OF electronics kits of every description, is a name associated with quality. Its products are often used as the standard to which other products, both kit and assembled, are compared.

One factor that has greatly contributed to Heath's (Benton Harbor, MI 49022) success is its highly detailed assembly manuals. The descriptions and illustrations provided are so clear and complete that even a first-time kit builder should have little trouble with most of them. If the manuals have any failings, it is that

their theory-of-operation sections tell you *what* is going on in the kits they refer to, but not *why*.

Heath has not ignored those kit builders who want to know "why." They offer an extensive line-up of educational electronics courses that carry on the company's tradition of quality. The courses cover a wide range of topics, including such things as basic and advanced electronics and components, microcomputers, programming, robotics, and amateur radio. We recently investigated one of their offerings, their *Semiconductor Devices Course*, and would like to tell you about it.

Subjects covered

That course, like most from Heath, is a self-contained unit. It is part of a basic electronics series, and uses information taught in the first two parts of that series; it does not, however, require that the earlier parts have been bought. As such, it is suitable for someone with some electronics background who wishes to brush-up on semiconductor fundamentals, or for the complete novice as part of a total educational program.

The course begins with a review of semiconductor-material and atomic fundamentals and then discusses the diode, the simplest semiconductor device. Among the things discussed are how that device works, and how it is used in a circuit. Also covered are special diode-devices, including Zeners, tunnel diodes, and varactors.

In similar fashion, the course deals with a variety of other semiconductor devices including bipolar and FET transistors, thyristors, IC's, and optoelectronic devices. The sections on bipolar transistors include discussions of the characteristics of those devices, as well as how they are used and how they behave in various types of circuits. The look at FET's includes a review of the features of the various types of FET's (JFET, IGFET, and MOSFET).

All of the units in the course cover their topics in sufficient depth to give a novice a thorough, practical understanding of the device in question. Consider the chapter on thyristors, for example. It describes the conditions necessary to turn on or off a silicon controlled rectifier, and explains the forward- and reverse-breakdown voltages of those devices. It then moves on to a discussion of the bidirectional triode-thyristor, and describes the basic operator of a bidirectional trigger-diode. The final part of the unit discusses in detail unijunctional transistors and their characteristics.

The section on integrated circuits discusses when and why they should—and should not—be used. Among the other topics covered are the differences among monolithic, film-type, and hybrid IC's, as well as linear and digital IC's, the types of IC packaging, and small-scale,

FORDHAM CUTS PRICES ON HITACHI SCOPES

SPECIAL

\$569⁹⁵
with probes

30 MHz Dual Trace



Model V-302F

High sensitivity. Bright screen. Rise time 12ns (for x 5) 70ns. Comes with probes.

20 MHz Dual Trace



Model V-202F

.55" square CRT • Vertical sensitivity 5m V/div to 5 V/div and 1m V/div to 1V/div with 5X amplifier • Display modes Ch1, Ch2, Dual, Add, Diff. • Comes with probes.

Model V-203F – Same as above but with Delayed Sweep.

35 MHz DUAL TRACE



Model V-352F

Vertical sensitivity 5m V/div to 5V/div and 1m V/div to 1V/div with 5X amplifier • Trigger modes Automatic, Normal, TV(+), TV(-) • Comes with probes.

Model V353F – Same as above but with Delayed Sweep.

60 MHz DUAL TRACE DELAYED SWEEP



Model V-650F

\$995
with probes

High sensitivity • 1 mV/div (10MHz) • 5 ns/div sweep rate • 3rd channel display (trigger view) • Variable trigger hold-off • Full TV triggering • Single sweep • Automatic focus correction • Comes with probes.

100 MHz QUAD TRACE DELAYED SWEEP

\$1590
with probes



Large, bright 8x10 cm screen • Quad trace operation/Ch1, Ch2, A trigger and B trigger • High sensitivity 500 μ V/div (5 MHz) • Full TV triggering • Comes with probes.

MINI-PORTABLE DUAL TRACE



Model V-209

3-way power supply, compact, lightweight package • High sensitivity 1m V/div at 10m Hz and fast sweep times 50 ns/div • Built-in TV sync separation circuit/TV-V & TV-H modes • Auto-focus • Comes with probes.

CALL FOR SPECIAL INTRODUCTORY PRICES TOLL FREE (800) 645-9518 in N.Y. State 800-832-1446

FORDHAM



- Master Charge
- VISA
- COD
- Money Order
- Check

260 Motor Parkway, Hauppauge, N.Y. 11788

SAVE!

MONEY • TIME • FREIGHT

QUALITY STEREO EQUIPMENT
AT LOWEST PRICES.

YOUR REQUEST FOR QUOTA-
TION RETURNED SAME DAY.

FACTORY SEALED CARTONS—
GUARANTEED AND INSURED.

SAVE ON NAME BRANDS LIKE:

PIONEER	JVC
KENWOOD	TEAC
MARANTZ	SANSUI
TECHNICS	SONY

AND MORE THAN 50 OTHERS
BUY THE MODERN WAY
BY MAIL—FROM

illinois audio

BANK CARDS ACCEPTED

12 East Delaware

Chicago, Illinois 60611

312-664-0020

800-621-8042

CIRCLE 94 ON FREE INFORMATION CARD

Put Professional Knowledge and a
COLLEGE DEGREE
in your Electronics Career through

HOME STUDY

Earn Your DEGREE

No commuting to class. Study at your own pace, while continuing your present job. Learn from easy-to-understand lessons, with help from your home-study instructors whenever you need it.

In the Grantham electronics program, you first earn your A.S.E.T. degree, and then your B.S.E.T. These degrees are *accredited* by the Accrediting Commission of the National Home Study Council.

Our *free* bulletin gives full details of the home-study program, the degrees awarded, and the requirements for each degree. Write for *Bulletin R-83*.

Grantham College of Engineering
2500 So. LaCienega Blvd.
Los Angeles, California 90034

medium-scale and large-scale integration.

The last part of the course deals with optoelectronic devices. It discusses the characteristics of light and explains the difference between radiometric and photometric measuring systems. Light-sensitive as well as light-emitting devices are described.

From the description of the course, you can see that it is set up in building-block style. One section logically follows the next and provides the user with all the basics needed as he progresses. If one wishes, the learning processes can be greatly aided through the use of an optional audio-visual package and the optional *ET3100B* trainer (we'll have more on that later).

The course comes complete with a soft-cover, looseleaf binder, which contains the course study material; various components for experiments, including resistors, transistors, diodes of various types, electrolytic capacitors, a small lamp, and a small plastic container to hold those parts, and an optional final exam.

Options

Heath suggests using its *ET3100B* trainer with this course. That unit consists of an experimenter's breadboard, dual variable power-supplies, and a dual-range variable sinewave and squarewave generator. Using that Heath trainer certainly does make performing the experiments easier, and helps you to learn the course material easier. The device should prove valuable later on after you complete the course when you are breadboarding your own designs. The course also requires the use of a good VOM or, at the student's option, an oscilloscope.

All the different parts of the course play a key role in helping the student learn. The loose-leaf binder study guide is written in an easy-to-follow style. Brief quizzes, to help assure the student that he completely understands the material presented, are scattered throughout the text and each unit concludes with a brief exam. The optional audio-visual package (cassette tapes and a picture-book) provides further reinforcement and the trainer provides valuable hands-on experience. With diligent study, this course assures the student mastery of the subject.

The course concludes with a final exam. Taking that exam is optional, but if it is completed and submitted to Heath, and if the score on that exam is at least a 70, the student earns three Continuing Education Units, a nationally recognized measurement of achievement in non-credit secondary education, as well as a certificate of achievement from Heath. It may also be possible to earn college credit for the course at some institutions.

The integration of all the course materials into a very effective instructional program is what makes taking the *Semicon-*

ductor Devices Course such a positive and rewarding experience. The basic course itself sells for \$54.95; when ordered with the *ET-3100B* trainer kit, the package can be purchased for \$134.90, which is a \$10 saving. (The trainer alone costs \$89.95 in kit form; \$159.95 assembled.) Add the \$19.95 audio-visual package, and you have a complete program for under \$155.

When the value and importance of the material is considered, and the cost compared to that of other programs currently available, that is not an unreasonable price to pay. **R-E**

• DISCOUNT HOME APPLIANCES •



"Sir, this goes with it—an emergency fire extinguisher."

Vital protection for PC Boards



Be safe. Desolder PC components with Endeco irons. Get *proper* HEAT TO MELT and *strong* VACUUM ACTION TO LIFT solder and *cool* both PC board and component without damage.

These PC components replaced fast with Endeco desoldering or soldering tools.



Endeco professional features include safety light that denotes *high*, *low* and *off* on switch models. SS construction for long life, light weight and balance for easy use.

Contact your distributor for Endeco desoldering and soldering irons, kits and equipment—or write us today.

Enterprise Development Corp.

5127 East 65th Street
Indianapolis, IN 46220
Phone: (317) 251-1231

CIRCLE 15 ON FREE INFORMATION CARD

VIDEO EQUIPMENT QUALITY • LOW PRICES OFF-THE-SHELF DELIVERY

from **FORDHAM** of course.

**BUY
OF THE
MONTH**



MODEL V-1880

BP STABILIZER/IMAGE ENHANCER/RF CONVERTER/ VIDEO FADER/2-WAY DISTRIBUTION AMPLIFIER

OUR PRICE **\$119.95** each

Most versatile video processor. Contains five units in one: stabilizer (video guard remover); image enhancer; video to RF converter; video fader; and dual output distribution amplifier.

Stabilizer Will correct entire range of copy guard distortion such as jitter, vertical roll or black bar travelling through picture.

Enhancer Lets you attain best picture for your own preference.

RF Converter Allows your TV set to receive video and audio signals from your image enhancer, guard stabilizer, video camera, computer, VCR, etc. The direct video signal from any video component can be fed into the V-1880 and converted to a usable RF signal that can go to your TV antenna terminals.

Video Fader Used to produce professional fade ins and fade outs.

BP VIDEO GUARD STABILIZER

MODEL V-1875



OUR PRICE **\$45.00** each

Has self contained A&B and bypass switch. Many movies, concerts and special programs for sale or rental are copy guarded. This removes copy guard and allows you to make copies. Many TV sets will not play prerecorded tapes because copy guard causes picture to roll and jitter, turn to snow or disappear. Video Guard Stabilizer removes copy guard from signal.

BP VIDEO GUARD STABILIZER/ RF CONVERTER

MODEL V-1877



OUR PRICE **\$69.95** each

Same as above but with a built-in RF Converter that gives the model V-1877 an RF output which can be fed directly to the antenna terminals of a TV set. This enables you to remove the copy guard from a pre-recorded tape and view it on a TV using only a VCR.

Use as an RF Converter only. Used in conjunction with your TV, you can feed direct audio and video signals from any video device such as video camera, computer, portable VCR, etc.

BP VIDEO SELECTOR CENTER

MODEL V-4803

OUR PRICE **\$49.95** each

A switcher that can accept 6 inputs and direct them to 3 outputs. Utilizes switch similar to one used on home VCR's. You avoid signal loss incurred by using splitters.



JERROLD 60 CHANNEL CORDLESS TV CONVERTER

MODEL DRX-3-105

OUR PRICE **\$110.00** each

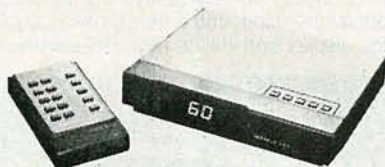

- Receive up to 60 TV channels
- Remote TV Control
- Attach to any age or model TV in minutes.
- No tools required.
- On/Off button.
- Channel selection.
- Channel Stepping.
- Fine Tuning.

JERROLD JRX TV REMOTE CONVERTER

MODEL JRX-3C105 (SWITCH)

OUR PRICE **\$74.95** each

Consists of two units - a receiver and transmitter. 20 ft. connecting cord is detachable at one end to help you position the unit. May be attached to any age or model TV in minutes. No tools required.

- Receive up to 36 channels.
- Remote TV control.



BP VIDEO CONTROL CENTER

MODEL V-4802

OUR PRICE **\$16.95** each

Provides remote control access of all Video, TV or Cable inputs to TV or Big Screen TV from one location by flipping switch.

- One output, your TV set or Big Screen TV
- Four inputs
- Completely passive, i.e. no AC power required to operate
- Auxiliary input and output provides added flexibility.



BP UHF CONVERTER FOR TV AND VTR

MODEL V-5736

OUR PRICE **\$24.95** each
5 FOR **\$100.00**

Use your VCR to its maximum capability. Record VHF, UHF, Cable or Pay TV while watching any other mode.

- FEATURES**
- 36 channels
- Allows complete programming of VTR
- Super color quality
- Watch or record any combination of selectable channels.
- Receives midband, superband/Pay and all VHF channels on UHF.
- For Beta/VHS type recorders or TV set
- Record and use TV's remote control.



BP IMAGE ENHANCER

MODEL V-1860

Dramatically improves performance of video cameras and VCR's (off-the-air or second generation recordings),

by compensating for deterioration of detail and sharpness. Includes video distribution amplifier with two video outputs, allowing you to make two copies at once without loss in signal level.



OUR PRICE **\$59.95** each

BP RF CONVERTER/MODULATOR

MODEL V-1885

OUR PRICE **\$39.95** each

Allows your TV to receive video and audio signals from image enhancer, guard stabilizer, video camera, computer, VCR, etc.

The outputs of many video components cannot be directly hooked up to the VHF antenna terminals on your TV set. This problem is solved by using the Model V-1885 RF Converter. Converts video signal from any video component to adjustable RF signal at antenna terminals. Allows your VCR output to feed two TV sets at the same time, with virtually no signal loss.



FORDHAM

260 Motor Parkway, Hauppauge, N.Y. 11788

- Master Charge
- VISA
- COD
- Money Order
- Check

N.Y. State residents add appropriate sales tax.

ADD FOR SHIPPING AND INSURANCE

\$250.00	\$4.50
\$251.00 to 500.00	6.50
501.00 to 750.00	8.50
751.00 to 1000.00	12.50
over 1000.00	15.00

COD's extra (required 25% deposit)

TOLL FREE (800) 645-9518

in N.Y. State call 800-832-1446

TRAIN AT HOME IN SPARE TIME!
NO PREVIOUS EXPERIENCE NEEDED!

FOR HOME OR BUSINESS! WHAT...WHEN...HOW



LEARN HOW TO USE A COMPUTER

Learn how and why a computer can help you. Learn to write your own computer programs. See how easy it is to use different programs already available. See how they fit into your home or business operations...budgeting, real estate, bookkeeping, inventories, expenses, pricing, profit margins, investments, interest, taxes, shopping lists, vacation planning, addresses, phone numbers, routing...hundreds more including foreign languages, computer games and graphics. Never again be at the mercy of a so-called "computer expert." Know what really happens when you get a computer problem from a bank, store, loan company, oil company, utility or anyone else. You'll be able to talk their language...understand why and how things happen...be able to take the offensive when you're the victim of a computer error.

**EXPERTS SHOW YOU WHAT TO DO,
HOW TO DO IT...TO MAKE YOUR LIFE EASIER**
Everything is explained in easy-to-understand language with plenty of examples. Step-by-step directions take you through basic computer programming. You learn everything you need to know to use the computer. You'll be able to understand computer experts and talk their language...storage, systems, terminals...you'll learn it all and much, much more.

NOW...ALL THIS IN ONE COURSE!

- Computer Training • Computer Programming
 - Computer Applications • Computer Games
- Find out what you need to know about computer operations



**TIMEX COMPUTER
INCLUDED WITH
YOUR TRAINING**
Plugs into any TV!

**SEND FOR
FREE FACTS!**

ICS
SINCE 1891

COMPUTER TRAINING, Dept. DE073
Scranton, Pennsylvania 18515

Please rush me free facts and color brochure that tells how I can learn computer applications, programming and operation at home in spare time. NO SALESMAN WILL CALL.

Name _____ Age _____
Address _____
City/State/Zip _____

NEW PRODUCTS

For more details use the free information card inside the back cover

MULTIFUNCTION COUNTER model 1805, measures frequencies from 5 Hz to 80 MHz. Resolution may be selected from .1 Hz for frequencies below 10 MHz to 1 Hz resolution for frequencies to 80 MHz.

The period mode can be used to measure low frequencies from 5 Hz to 2 MHz accurately. The totalize mode counts individual events from 0 to 99,999,999 plus overflow LED. That mode is helpful in applications where a specific number of cycles occurs, such as gated tone bursts.

For lessened susceptibility to noise and undesirable high-frequency components, a front-panel switchable 100-kHz lowpass filter is incorporated in the counter. All operating modes, resolution ranges, and functions are front-panel selectable. The model 1805 incorporates a switchable $\times 10$ attenuator, HOLD switch to freeze the display at the present reading, and a RESET switch to clear the display and initiate new measurement.



CIRCLE 111 ON FREE INFORMATION CARD

The model 1805 has a suggested price of \$290.00.—**BK Precision, Dynascan Corporation**, 6460 West Cortland Ave., Chicago, IL 60635.

CRT TESTER, model CR70, is the first CRT tester designed to test all CRT's with only six adaptors. It handles electrical variations with five setup switches, one for each element of the electron gun. Its second exclusive feature is its "CRT-type" switch which makes it the only CRT tester/restorer that works with scope CRT's and projection CRT's as well as with standard video and computer-display CRT's. Setting that switch to the proper position mechanically adjusts the sensitivity of the test circuits and the current supplied during cathode restoring for safe, reliable results.

Other exclusive model CR70 features include: (1) The industry's only dynamic-emission test, testing the electron gun for true beam current at both the black and white emission levels; (2) a patented color-tracking test that automatically calculates the emission-current ratios to industry standards for a color CRT or for the three CRT's of a projection system; (3) five levels of "pro-



CIRCLE 112 ON FREE INFORMATION CARD

gressive restoration", guaranteed to improve the performance of nine out of ten CRT's encountered with shorts or weak emission; (4) the ability to determine setup data directly from a schematic for CRT's not listed in the setup book, and (5) complete protection from shorted CRT's or CRT's with high voltage.

The model CR70 is priced at \$975.00. To make it truly obsolete-proof, there is an optional universal adaptor to connect to non-standard CRT bases or to newly introduced bases. The adaptor is priced at \$30.00.—**Sencore**, 3200 Sencore Drive, Sioux Falls, SD 57107.

ENHANCEMENTS for the Timex Sinclair 1000 computer, are the *Memotech Keyboard* (shown), the *Memocalc*, the *Memotext*, and the *Memopak Assembler*.

The *Memotech Keyboard* with interface is a professional standard (typewriter) keyboard with Sinclair legends. It is housed in an enclosure, and the interface is buffered and housed in a Memopak case, which plugs directly into the back of the Sinclair, and does not inhibit the use of further add-on units. It is priced at \$99.95.

The *Memocalc* is a tool to assist you with reports and financial forecasts. This spreadsheet analysis software, on EPROM, enables users to perform complicated number-crunching routines easily. With the 64K RAM, a table of up to 7000 numbers, up to 250 rows or 99 columns can be specified. Quick revisions can be achieved by entering new data to your formula; then, by entering the command CALCULATE, the information is re-evaluated and displayed. The *Memocalc* is priced at \$49.95.

The *Memotext* word processor brings com-

MOVING?

Don't miss a single copy of **Radio-Electronics**. Give us:

Six weeks' notice

Your old address and zip code

Your new address and zip code

ATTACH
LABEL
HERE

name (please print)

address

city state zip code

Mall to: Radio-Electronics
SUBSCRIPTION DEPT., P.O. BOX 2520,
BOULDER, COLO. 80322

CANCER. NOT KNOWING THE RISKS IS YOUR GREATEST RISK.

A lot of people think cancer is unbeatable.

That simply isn't true. In fact, over two million people have had cancer and survived to lead happy, normal lives.

And not only can cancer be beaten, it can also be prevented.

There are definite precautions that have been proven to decrease your risk of getting certain cancers.

Ask your local American Cancer Society to send you a free booklet about cancer risks.

Learn the facts about cancer.

And make not knowing the risks, one less risk.

AMERICAN CANCER SOCIETY
How you live may save your life.

This space contributed as a public service.

FREE!

**ELECTRONICS™
WAREHOUSE**

BI-MONTHLY CATALOG AVAILABLE NOW.

*Hundreds of products offered
from test equipment to
computers and accessories.*

MAIL TO:

ELECTRONICS WAREHOUSE, INC.
Catalog Subscription Dept.
Box 624, Old Lyme,
CT 06371
(203) 434-8308

CIRCLE 33 ON FREE INFORMATION CARD

Radio Electronics

COMPUTERS - VIDEO - STEREO - TECH

Build this
DIGITAL IC TESTER
for your workbench

How to
ETCH PC BOARDS
at home

Back-to-school series
OP-AMPS
How to properly use them

How to
INTERFACE PROCESSORS
and make them useful

Build a
LOW-BAND CONVERTER
and listen in below 535 kHz



PLUS:
State-Of-The-Art
Digital lock circuit

New Idea
Budget sound effects generator
Service Clinic
Computer Corner
Equipment Reports

This will be coming to you when you subscribe to **Radio-Electronics**:

- HELPFUL CONSTRUCTION ARTICLES
- NEWS ON NEW TECHNOLOGY
- FASCINATING "HOW TO DO IT" ARTICLES
- HOW YOU AND THE COMPUTER CAN BE FRIENDS
- NEW AUDIO DIMENSIONS FOR YOUR PLEASURE
- TV WONDERS FOR YOUR FUTURE
- AND you also get regular MONTHLY FEATURES

Get it all!

Radio-Electronics covers all aspects of the fast moving electronics field...featuring
COMPUTERS • VIDEO • STEREO • TECHNOLOGY
• SERVICE • COMMUNICATIONS • PROJECTS

Subscribe today to **Radio-Electronics**. Don't miss a single issue and...you save as much as \$7.03 off the newsstand price.

When you select one of the subscription offers listed on the handy coupon—you'll be assured of having your copy reserved even if it sells out on the newsstand. Make sure you get all the excitement in every issue of **Radio-Electronics**, every month, by filling in and mailing the coupon, today.

Every Month! Get the Best—Mail Today!

Mail to: **Radio-Electronics**, 7HH32
P.O. Box 2520, Boulder, CO 80322

- 1 year—12 issues only \$14.97 (You save \$3.03 off newsstand price.) Payment Enclosed
 2 years—(Save More)—24 issues—\$28.97 (Save \$7.03 off the newsstand price.) Bill Me

Name _____ (please print)

Address _____

City _____ State _____ Zip Code _____

Offer Valid in U.S. Funds Only
Allow 6-8 weeks for delivery of first issue

Canada add \$3.00 per year
All other countries add \$7.50 per year

AUGUST 1983

The "OUT FRONT" DMM



HICKOK'S LX-306 PIED PIPER with exclusive Vari-Pitch®

... combines the best of DMM's, analog meters, logic probes, tracers and continuity testers into one compact unit. The LX-306 offers 0.25% accuracy and all functions and ranges featured by other leading DMMs; PLUS, VARI-PITCH, the audible DMM tone system that obsoletes all others.

VARI-PITCH changes tone proportionate to the signal input. Its usage is limited only by your imagination. Imagine:

- Troubleshooting by character or "signature" sound.
- Detecting ripple or noise on the power supply line.
- Quickly locating intermittents.
- Locating and testing capacitors in a circuit.
- Making analog-type peaking and nulling adjustments.
- Reducing troubleshooting time by 25% or more.

The LX-306 is the ideal DMM for tough jobs and busy schedules. Built to fit your hand and your budget!

LIST PRICE ~~\$155.00~~

LIMITED TIME OFFER \$139.00

See your Hickok distributor, or contact:



THE HICKOK ELECTRICAL INSTRUMENT CO.
10514 Dupont Avenue • Cleveland, Ohio 44108
(216) 541-8060 • TWX: 810-421-8286

CIRCLE 85 ON FREE INFORMATION CARD

mercial standards of text editing to the TS-1000 computer. Text is first arranged in 32-character lines for the screen, with comprehensive editing facilities. On output, the user simply chooses the line length for printing, and the system does the rest. The Memotext is priced at \$49.95.



CIRCLE 113 ON FREE INFORMATION CARD

The Memopak Assembler is for those who want to control the power of their computer precisely. It lets you code and edit a source program in Z80 assembly language, and then assemble in machine code. You can now write flexible and economic programs, tailor-made in every detail to your own needs, and free from the extravagant use of time and space that goes with the BASIC high-level code. The editor mode allows you to code directly in the right format, manipulate individual lines, and control the exact placing of source and machine code. Routines may be merged or listed (even to a commercial printer with Memotech's printer interfaces.) The Memopak Assembler is priced at \$49.95.—**Memotech Corporation**, 7550 West Yale Avenue, Denver, CO 80227.

CAR AMPLIFIERS, model HPA-51 and model HPA-71 (shown) are high-power, low-distortion car-stereo amplifiers, designed to be trouble-free. Both models feature self-protection circuits such as a speaker transient-protection relay, output short-circuit protection, and output thermal-overload protection. Both have provision for low-level or high-level inputs.



CIRCLE 114 ON FREE INFORMATION CARD

The model HPA-51 produces 100 watts total (50 watts per channel) at 0.5% THD or less from 20-20,000 Hz into a 4-ohm load. Its suggested retail price is under \$200.00.

The model HPA-71, designed to appeal to the higher-power performance enthusiast, produces 140 watts total (70 watts per channel) at 0.5% THD or less from 20-20,000 Hz. Its suggested retail price is under \$270.00.—**Concord Electronics**, 6025 Yolanda Avenue, Tarzana, CA 91356.

TEMPERATURE PROBE, model 15, offers fast response time, Fahrenheit or Centigrade temperature measurements with $\pm 2^\circ\text{C}$ nominal accuracy. Portable and plug-in adaptable to any analog or digital multimeter



CIRCLE 115 ON FREE INFORMATION CARD

with 10 megohms or more input impedance, the battery-operated model 15 is suited for many industrial-, commercial-, or service-oriented temperature-measurement applications.

The fast-responding silicon sensor provides temperature measurements ranging from -58°F to 302°F , -50°C to 150°C with $\pm 2^\circ\text{C}$ accuracy over 0°C to 100°C . Output voltage is 1 millivolt DC per degree, F or C. The model 15 has a life of approximately 3500 hrs when powered by two 1½-volt "AA" alkaline batteries. There is a battery-check function that lets the user know the status of the battery instantaneously. A single switch provides $^\circ\text{C}$, $^\circ\text{F}$, or battery-check/OFF functions. The model 15 is priced at \$75.00.—**Triplett Corporation**, Bluffton, OH 45817.

MICROPHONE, the model SP19, is designed to provide a high level of performance and is suitable for a wide variety of applications, especially home reel-to-reel and cassette recording. It is also useful for general-purpose use in schools, hospitals, churches and other public-address applications, musical groups, etc.

The model SP19 also features a pop-resistant, multi-stage steel-mesh grille assembly, an on-off switch, a 15-foot permanently attached cable, and a professional accessory swivel adaptor. It is built to withstand rough treatment.

The model SP19 is available in two versions: SP19H-C (high impedance, with a ¼-inch phone plug at the cable's equipment end) and SP19L-CN (low impedance, with a



CIRCLE 116 ON FREE INFORMATION CARD

professional 3-pin connector at the cable's equipment end). The suggested retail price is \$48.00 for each model.—**Shure Brothers, Inc.**, 222 Hartrey Avenue, Evanston, IL 60204. **R-E**

The complete library of replacement semi's.

ECG212L
Suggested Price \$3.25

• ECG[®] Semiconductors

Master Replacement Guide

- Entertainment • Industrial • Commercial
- Equipment Maintenance and Repair



**If it's ECG, it fits.
And it works.**

Sylvania Electronic Components

Here's the one guide that has it all—the new ECG[®] Master Guide. It's 545 pages, packed with over 3000 ECG semiconductors that replace over 200,000 industry numbers. And our replacements meet or exceed the specs of the original parts. So if it's ECG, you can count on it to fit and work.

Reduce equipment downtime and save yourself endless hours of parts hunting. For everything from analog amplifiers to zener diodes, go with replacement semiconductors from ECG. Get your new ECG Master Guide and our "Counterpoints" product updates from your nearest distributor. For his name and number, call 1-800-225-8326 toll-free (in Massachusetts, dial 1-617-890-6107). Or just send \$3.25 for your ECG Master Guide to Philips ECG, Inc., Dept. RE, 70 Empire Drive, West Seneca, NY 14224.

**If it's ECG, it fits.
And it works.**

Philips ECG

A North American Philips Company

SOLTEC®

DESIGNER'S NOTEBOOK

SOLTEC MODEL 5100 100MHz OSCILLOSCOPE

- 4 Channels / 8 traces
- Fast sweep speeds from 2nS/DIV
- Dual Time Base
- High sensitivity from 2mV/DIV
- Glass epoxy circuit boards
- 15,000 MTBF
- Brilliant intensity, domed-mesh CRT
- Patented AUTO-FIX circuit for easy triggering
- Jitter-free trigger circuit
- Two year parts and labor warranty

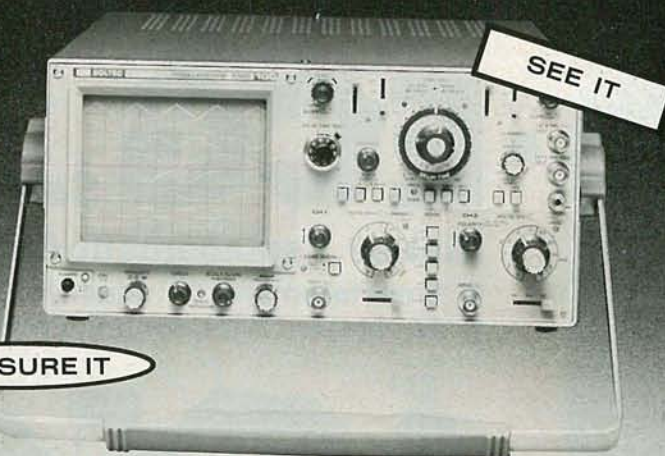

MEASURE IT

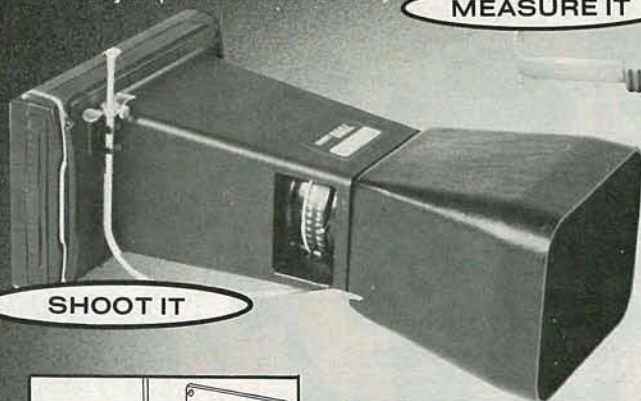

SHOOT IT

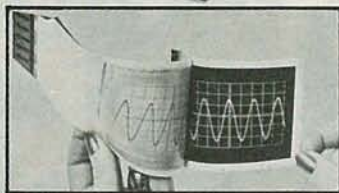
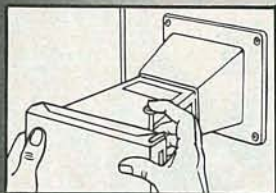

SOLTEC 7000 OSCILLOSCOPE CAMERA FAST AND EASY TO OPERATE

- Fits all Oscilloscopes and most Logic Analyzers
- Can be hand-held or mounted
- Uses standard Polaroid® film
- Variable aperture control: f3.5 - f32
- Variable shutter speeds: 1 second to 1/125th & B
- Built-in "X" contact for event triggering
- \$397.00 complete, hand-held with hood

QUANTIFY IT



NEW SOLTEC BENCH TOP MULTIMETERS

- 3½ - 4½ - 5½ - Digit Resolution
- Ultra high accuracy
- Auto-ranging and manual operation
- Built-in battery charger - all units
- BCD and Analog output available, all units
- Expanded over-range protection
- Metal case eliminates RFI, adds durability
- One year parts and labor warranty

GP-IB



NEW SOLTEC BENCH TOP COUNTER/TIMERS

- 100MHz, 110MHz and 150MHz
- Optional 1.2GHz prescalers
- Channel ratio and time interval comparison
- Interval self-check

SOLTEC® CORPORATION

11684 Pendleton Street
Sun Valley, California 91352 U.S.A.
(213) 767-0044 • 800 - 423-2344

OSCILLOSCOPES

SCOPE CAMERAS & PROBES

DMMS & FREQUENCY COUNTERS

The Life and Times of

ASK ANY ELECTRICAL ENGINEERING STUDENT today to tell you something about Nikola Tesla, and you are likely to get a blank stare. Or the counter-question: Who was Tesla? It seems preposterous that our educators should have ignored entirely the "father" of our AC age, but such is the fact. Something should be done about our technical education system.

Born July 9, 1856 in the village of Smiljan in what is now Yugoslavia, Tesla rose from relative obscurity to a top position in the scientific world. He became a millionaire at age 32 through his important inventions, but later faded into obscurity and died nearly penniless.

His father was a clergyman. His mother, though she never learned to read and write, was known in the community as an inventor of domestic labor-saving devices, and it is to her that Tesla attributed much of his inventive genius. The young Tesla, opposing his father's urging to study for the ministry, insisted on a career in engineering. His mother encouraged him. He attended the polytechnic school at Graz (now part of Austria), specializing in physics and mathematics, and continued his education at the University of Prague. There he took a course in foreign languages so that he would be able to read foreign technical literature. He became proficient in English, French, and Italian, in addition to German and his native Serbian.

Finishing at Prague in 1880, he took a post-graduate course in Budapest, where he debated the merits of alternating current with his professors. He then went to work for a Paris telephone company, where he acquired considerable experience with DC dynamos and motors.

In those early days, direct current was universally acknowledged to be the only practical medium for generating, transmitting, and using electricity for heat, light, or power. But DC resistance losses were so great that a power plant was needed for every square mile served. Early incandescent lamps, glowing none too brightly on 110 volts even close to the power plant, became pitifully dim on the power that dribbled from the lines less than a mile away. And everyone believed that motors could run only on DC. An alternating-current motor was considered an impossibility.

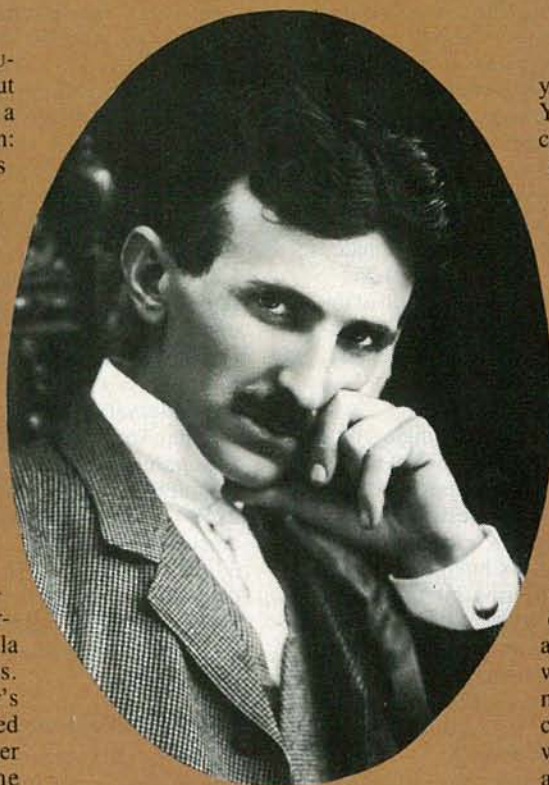

NIKOLA TESLA

Although now largely forgotten, Nikola Tesla was either responsible for, or predicted, much of the technology we now take for granted. Here's a look at the life and achievements of that fascinating man.

That was the picture when, in 1884, young Tesla stepped off a ship in New York, his head full of ideas, and four cents in his pocket. His experience had convinced him that the commutator in direct-current motors and dynamos was an unnecessary complication, causing endless troubles. He realized that the "DC generator" actually produced AC, which was converted to DC by the commutator. Then, to get that DC to produce rotary motion in a motor, the process had to be reversed. The armature of each electric motor was equipped with a rotating switch (commutator) that changed the polarity of its magnetic poles just at the right instant as it rotated to supply AC to the motor.

To Tesla, that was sheer nonsense. It seemed much more logical to eliminate the commutator at both generator and motor, and use AC through the whole system. But no one had ever built a motor that could operate on alternating current, and Tesla struggled mentally with the problem. Then one day in February, 1882, while strolling with a classmate named Szigetti in a Budapest park, he suddenly blurted out: "I've got it! Now watch me reverse it!" At that moment he had visualized the rotating magnetic field, which would revolutionize the whole electrical industry. He saw the magnetic pull racing around the stationary field (stator) of his motor while the armature (rotor), attracted by the moving field, chased around after it faster and faster until it was revolving at the same rate. He would need no switching to the rotating element—no commutator!

Subsequently he worked the whole alternating-current electrical system out in his mind—including alternators, step-up and step-down transformers for economical transmission and delivery of electric power, and AC motors to supply mechanical power. Impressed by the wealth of available water power going to waste around the world, he visualized the harnessing of that great supply with hydro-electric plants capable of distributing the power to where it was needed. He startled fellow-students in Budapest by announcing: "Some day I will harness Niagara Falls."

The opportunity and fortune Tesla sought in the promised land did not come easily. When he met Edison, then actively engaged in developing a market for his incandescent lamp through his pioneer Pearl Street plant in New York, Tesla

launched with youthful enthusiasm into a description of his alternating-current system. "You are wasting your time on that theory," the great man told him, dismissing the idea promptly and finally.

For a year the tall, gaunt Yugoslav struggled to keep from starving in this strange land. At one point he dug ditches to make a living. But the foreman of the Western Union ditch-digging project on which he was working listened to the visionary descriptions of new electrical systems that Tesla related during lunch hours, and introduced him to a company executive named A.K. Brown. Fascinated by Tesla's vivid plans, Brown and an associate decided to take a flyer. They put up a limited amount of money, with which Tesla set up an experimental laboratory at 33-35 South Fifth Avenue (now West Broadway). There Tesla set up a complete demonstration of his system, including generator, transformers, transmission line, motors, and lights. He worked tirelessly, and without drawings; the plans for every detail were indelibly etched in his mind. He even included two-phase and three-phase systems.

Professor W.A. Anthony of Cornell University examined the new AC system, and promptly announced that Tesla's synchronous motor was equal in efficiency to the best DC motors.

Alternating-current arrives

Tesla attempted to patent his system under a single comprehensive patent covering all its components. The Patent Office would not approve the all-in-one application, insisting on separate applications for each important idea. Tesla's applications, filed in November and December of 1887, resulted in the granting of seven U.S. patents in the next six months. In April 1888, he filed for four more patents, covering his polyphase system. Those too were promptly granted, as were 18 more U.S. patents later in the year. Numerous European patents soon followed. Such an avalanche of patents, so promptly issued, was without precedent. But the ideas were so novel—completely absent was any element of interference or "anticipation"—that the patents were issued without a single challenge.

Meanwhile Tesla staged a spectacular lecture and demonstration of his AC system—single-phase and polyphase—at a meeting of the AIEE (now the IEEE) in New York. The engineers of the world were made aware that the limitations on electric-power transmission by wire had been removed, opening the door to tremendous expansion.

But who would adopt this obviously better system? Certainly not the established Edison-General Electric organization—it would have made their whole investment obsolete. Apparently Tesla was stuck with no market, no customer for what he had to offer.

It was at that moment that George Westinghouse walked into Tesla's laboratory and introduced himself. Tesla was then 32 years old, Westinghouse 42. Both were capable inventors, accomplished engineers, and electrical enthusiasts. Westinghouse listened to Tesla's explanations, watched his demonstration, and quickly made up his mind.

"I will give you one million dollars cash for your alternating current patents, plus royalties," offered Westinghouse.

"Make that royalty one dollar per horsepower, and it's a deal," replied Tesla, without apparent excitement. As simply as that, the two men arranged the historic deal and shook hands on it.

Tesla had arrived. But he was not a man to forget those who had placed their faith in his ideas, and promptly signed over half his million-dollar fee to Brown and his associate, who had financed his laboratory. Although Westinghouse's backers later forced him to get a release from Tesla on the dollar-per-horsepower part of the agreement, such was the friendship that had developed between the two men that an amicable settlement was quickly reached. Tesla relinquished the royalties that would have supported him and his research efforts for the rest of his life.

The phenomenal success of the Westinghouse AC-systems across the nation made it clear to General Electric engineers that

they would have to get a license from Westinghouse if they were to keep up with the rapidly expanding electrical industry. The license—negotiated at a handsome fee—was a feather in Tesla's cap; he never forgot Edison's statement that there was no future in alternating current and that experimenting with it would be a waste of time.

A dream realized

In 1890, the International Niagara Commission began its search to find the best way of using the power of Niagara Falls to generate electricity. The scientist Lord Kelvin was appointed chairman of the Commission, and immediately announced that a DC system would obviously be best! It was not easy to challenge that world-famous authority, but Kelvin eventually came to realize that if power were to be transmitted even the 26 miles to Buffalo, AC would be necessary. Thus, it was decided to use Tesla's system and generate AC with massive water turbines. Bids were invited by the newly formed Cataract Construction Co. in 1893. Westinghouse won the contract for the ten 5000-horsepower hydro-electric generators, and General Electric the contract for the transmission system. The whole system including the line and the step-up and step-down transformers followed Tesla's two-phase design. He designed the big alternators with external revolving fields and internal stationary armatures, to minimize the weight of the moving members.

That historic project created a sensation, for nothing of that magnitude had been attempted up to that time. The ten big 2250-volt alternators, revolving at 250 rpm and delivering 1775 amperes each, produced an output of 50,000 horsepower, or 37,000 kilowatts, 25 Hz, two-phase. The rotors were 10 feet in diameter and 14 feet long (actually, 14 feet high in those vertical generators) and weighed 34 tons each. The stationary members weighed 50 tons each. The voltage was stepped up to 22,000 for transmission.

Remote radio control

Tesla's pioneer work in radio ("wireless" as it was then called) went beyond just Morse code communication. In 1898 he staged a spectacular demonstration of remote control without wires at the original Madison Square Garden in New York City. The first annual Electrical Exhibition was then in progress, and in the center of the vast arena where Barnum and Bailey's circus usually performed he had a large tank built and filled with water. Afloat on that small lake he had a 3-foot iron-hulled boat. Inside the hull was a radio receiver and an assortment of electric motors, driven by a storage battery, to perform various ship-functions. The receiver's antenna was mounted on the boat's mast.

From the opposite end of the auditorium, Tesla put the vessel through a variety of maneuvers, including sailing forward, steering left and right, stopping, reversing, and lighting the lights in its rigging in response to audience requests. The impressive demonstration of course "stole the show" and made the front page of the daily newspapers. But how many dreamed that one day, using those same radio-remote-servo-control principles, we would land a man on the moon?

Mathematical wizardry

Tesla's mathematical genius stood him in good stead in the design of the AC equipment for Westinghouse and GE. (In his early student days, he solved complex problems in his head, without pencil and paper. His teachers suspected him of cheating, but young Tesla, it turned out, had memorized whole logarithmic tables!) The now established frequency of 60 Hz stems from Tesla's mental calculations, which convinced him that it was the most practical frequency for commercial use. At higher frequencies, AC motors would become inefficient; at lower frequencies they would require too much iron. Lights would also flicker at low frequencies.

Though the original Niagara Falls plant was designed for 25 Hz to accommodate the limitations of the early Westinghouse turbine generators, subsequent expansion included conversion

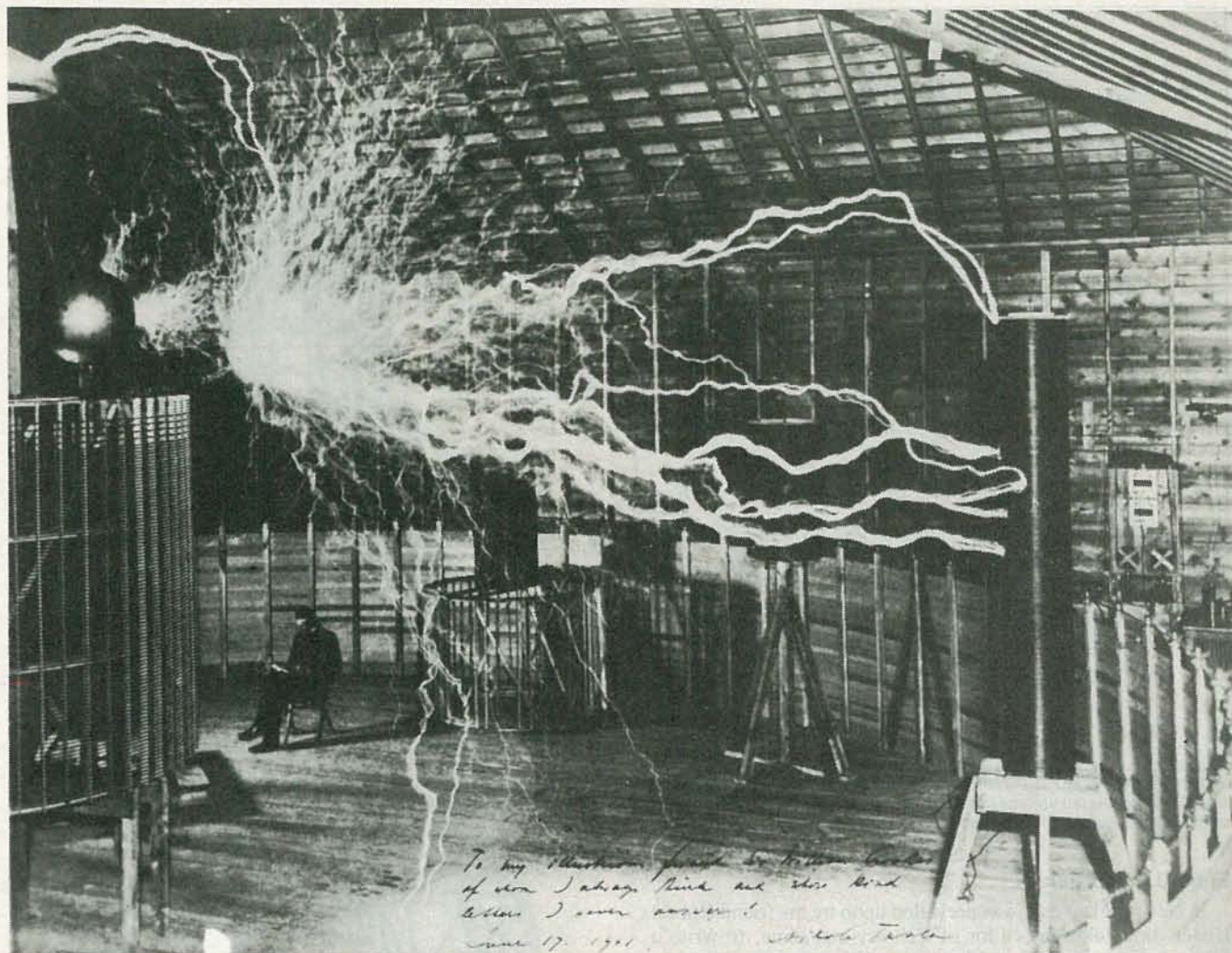

FIG. 1—TESLA AND HIS COILS. Tesla sits in his Colorado research station while 12 million volts of manmade lightning slash around him.

to 60 Hz. Today power from Niagara is transmitted all the way to New York City, 360 miles away, and at times is fed over the Northeast power grid for much greater distances. Remember, when Tesla arrived in New York, the limit for efficient power transmission was less than a mile!

High-frequency pioneering

During his research in high voltage and high frequency, Tesla adopted a most sensible practice. When handling high-voltage apparatus, he always kept one hand in his pocket. He insisted that all his laboratory assistants take that precaution, and to this day that is always done by sensible experimenters when working around potentially dangerous high-voltage equipment.

Tesla's work with high frequencies and in the field of high voltage paved the way for modern electronics, although the word had not yet even been coined. With his unique high-frequency transformers, now called Tesla coils (see Fig. 1), he showed that he could actually pass millions of volts harmlessly through his body to glow-tube lamps held in his bare hands. They would light up to full brilliancy from the high-frequency, high-voltage currents. In those early days he was actually demonstrating neon-tube and fluorescent-tube lighting!

Tesla's experiments with high and low frequencies sometimes had unexpected results. Studying slow mechanical vibrations, he caused a virtual earthquake in the vicinity of his new laboratory on Houston St. in New York City. His mechanical oscillator, operating at close to the natural period of the building itself, threatened to tumble the old structure. Furnishings in a

police station over a block away began to dance around mysteriously as Tesla confirmed his mathematical theories of resonance, vibration, and "natural periods."

World's most powerful transmitter

Investigations of high-voltage and high-frequency electrical transmission led Tesla to build and operate the world's most powerful radio transmitter on a mountain near Colorado Springs (see Fig. 2). Around the base of a 200-foot mast, he built a 75-foot diameter air-core transformer. The primary was only a few turns of wire. The secondary within it was 100 turns, 10 feet in diameter. Using power from a generating station several miles away, Tesla created the first man-made lightning. Deafening bolts 100 feet long leaped from the 3-foot copper ball at the top of his mast. He was using voltages of the order of 100 million—a feat not to be equalled for half-a-century.

Tesla burned out the power-plant generator with his first experiment, but repairing it, continued his experiments until he was able to transmit power without wires for a distance of 26 miles. At that distance he was able to light a bank of 200 incandescent lamps—a total of 10 kilowatts. Fritz Lowenstein, later to become famous for his own radio patents, witnessed that spectacular accomplishment, as Tesla's assistant on the project.

By 1899, Tesla had somehow spent the last of the money he got from Westinghouse for his AC patents. Colonel John Jacob Astor came to his financial rescue, and put up the necessary \$30,000 for the Colorado Springs experiments. Now that money was also gone, and Tesla returned to New York.

*To my Mother, friend & brother
of whom I always think and who kind
allows I ever succeed!
June 17, 1901 Nikola Tesla*

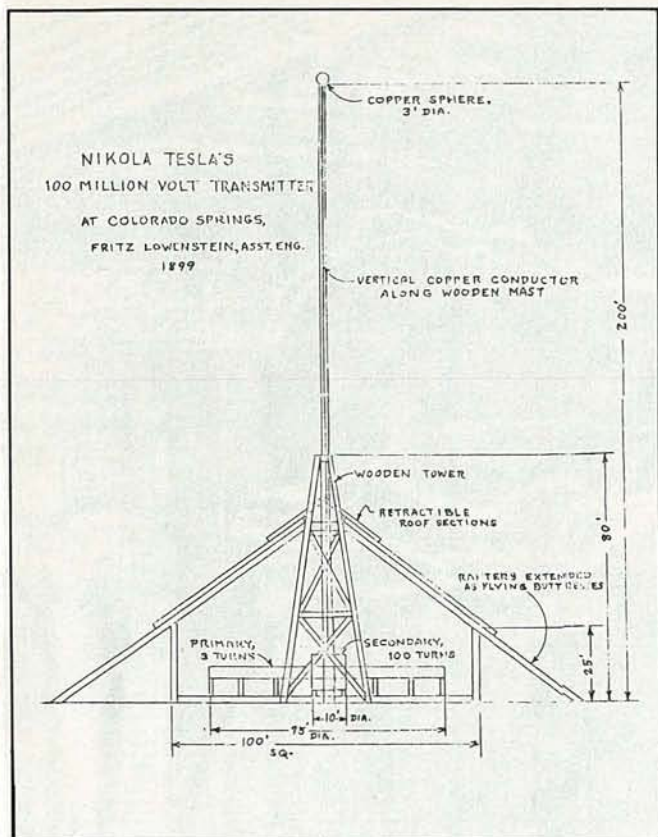

FIG. 2—WORLD'S MOST POWERFUL TRANSMITTER. Using this installation, Tesla generated voltages on the order of 100 million, a level not to be equalled for nearly half a century.

Enter J.P. Morgan

In New York, Tesla was prevailed upon by his friend Robert Underwood Johnson, editor of *Century* magazine, to write a feature story describing his accomplishments at Colorado Springs. But the story Tesla turned out proved to be an involved discourse on the subject of philosophy and "the mechanical process of humanity." Although of the highest literary quality, the treatise said little about the powerful transmitter at Colorado Springs. Johnson had to return the manuscript three times before getting some coverage of the subject he had requested.

In the end, the article was published under the title "The Problem of Increasing Human Energy." It created a sensation when it appeared in print. One of the readers who was deeply impressed was John Pierpont Morgan, who had financed the General Electric Co. in its pioneer DC days, and later in its part in the Niagara Falls project. Morgan was fascinated by the genius of Nikola Tesla, by his spectacular accomplishments, and by his winning personality. Tesla soon became a regular guest at the Morgan home. Impeccably dressed, always the polished gentleman with European manners and cultured speech in several languages, Tesla became a favorite of New York and Newport society. Many prominent matrons regarded him as a "good catch" for their daughters, but Tesla insisted that there was no room in his life for women and romance—they would interfere with his research efforts.

Historians differ on what motivated Morgan to finance Tesla's next big project. Some believe that he was genuinely interested in the wireless transmission of power. Others argue that—in the light of subsequent developments—it seems obvious that Morgan's interest was in getting control of Tesla and his achievements to protect the Morgan investments in the electrical industry.

Finding that Tesla was broke again, Morgan agreed to underwrite Tesla's project of transmitting electric power without wires. In 1904, Tesla acknowledged in *Electrical World and Engineer*: "For a large part of the work I have done so far I am

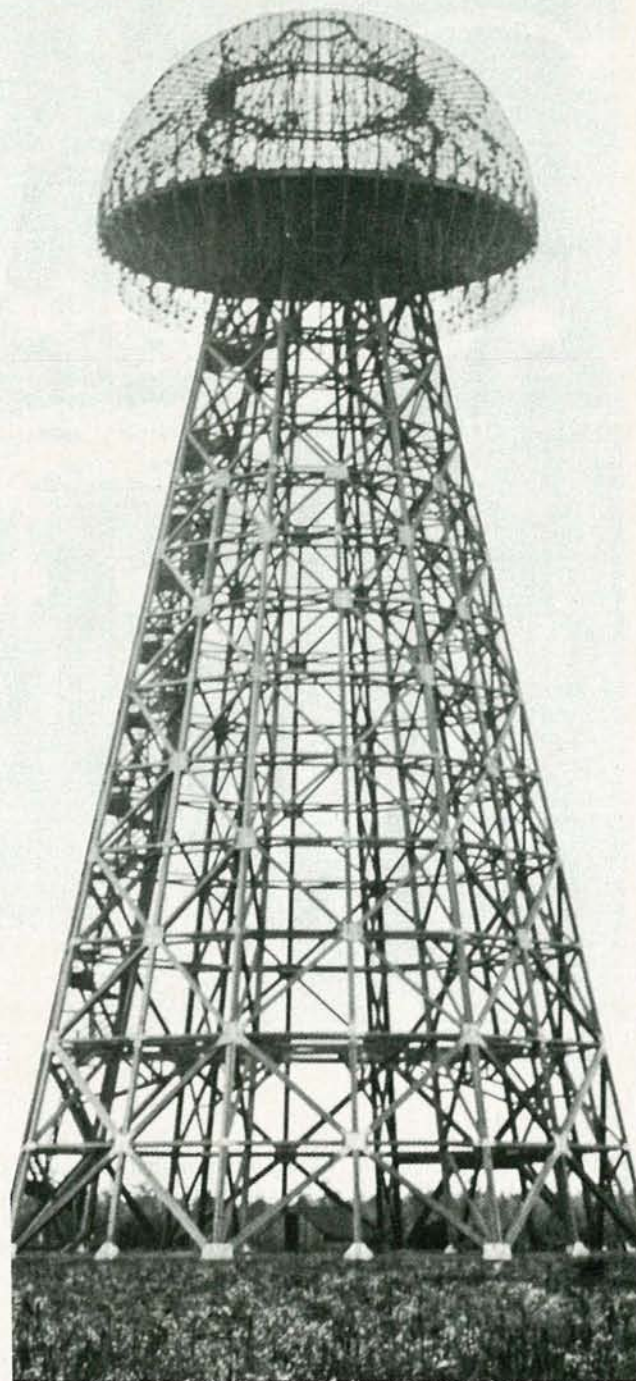

FIG. 3—THE WORLD-WIDE WIRELESS TOWER. Built on Long Island, the mysterious project was never completed.

indebted to the noble generosity of Mr. J. Pierpont Morgan."

From that alliance sprouted the fantastic "world-wide-wireless" tower erected on Long Island; that tower is shown in Fig. 3.

World-wide wireless

The strange structure that slowly rose near Wardencllyffe, in the hilly portion of Long Island, mystified all observers. Resembling a huge mushroom, except that it was not solid, it had a lattice-work skeleton, broad at the base and tapering toward its 200-foot top. There it was capped by a 100-foot diameter hemisphere. The structure was made of stout wooden members joined by copper gussets bolted to the wood with sturdy bronze bolts. The hemispherical top was draped over its upper surface with copper mesh. There was no ferrous metal in the entire structure.

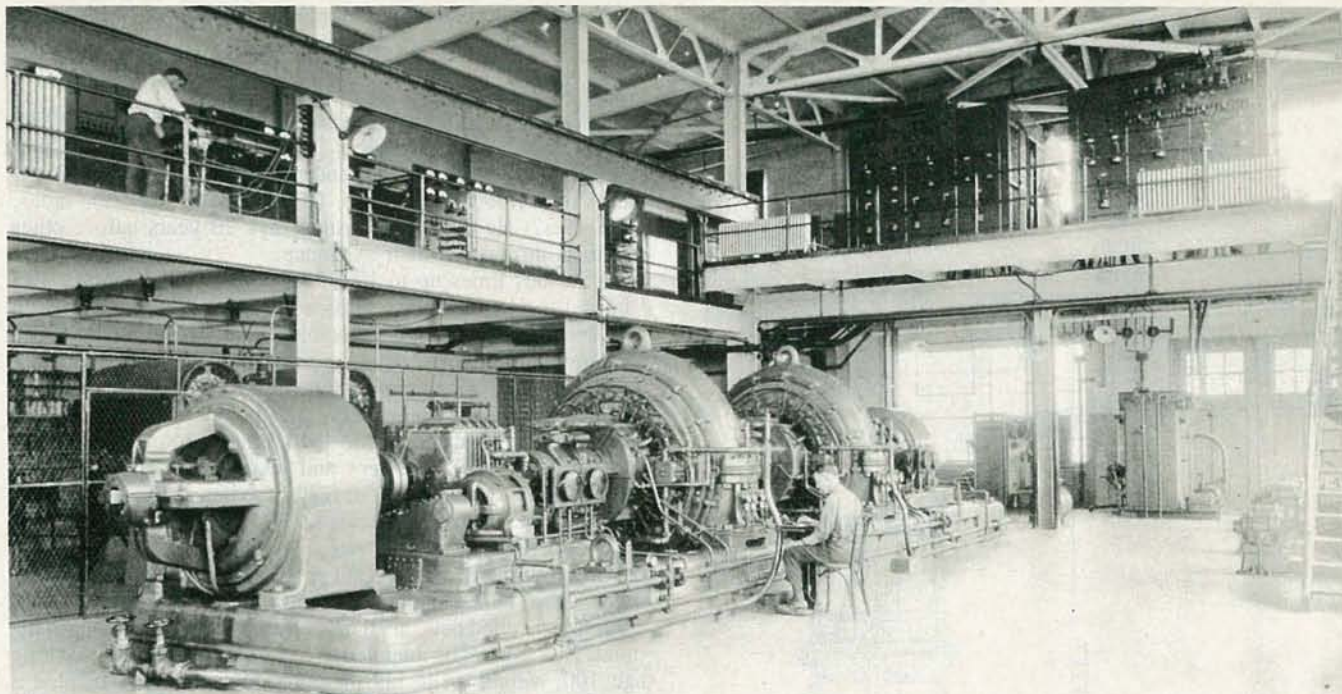

FIG. 4—RF ALTERNATORS, such as this first one installed in New Brunswick, NJ, provided the first reliable transatlantic radio communications.

The famous architect Stanford White became so interested in the project that he did the design work without charge, assigning one of his best designers, W.D. Crow, to the task.

Tesla commuted daily to the construction from his quarters in the old Waldorf-Astoria Hotel on 34th St., riding the streetcars to the East 34th St., ferry, then the paddle-wheel steam ferry to Long Island City and the Long Island Railroad to Shoreham. The railroad's dining service prepared special meals for him so that his supervision of the project would not be interrupted.

When the 100-foot-square brick power plant was completed near the base of the big tower, Tesla began moving his Houston St. laboratory into the structure. Meanwhile, various annoying delays were encountered in the manufacture of the radio-frequency generators. Several glassblowers were busy fashioning special tubes, the design of which remains a mystery to this day.

Tesla's vision

Meanwhile, Tesla issued a descriptive brochure that revealed his far-reaching insight into the future of the great industry that at that time (1904) was limited to dot-and-dash telegraphy. That document has persuaded many that the man was actually clairvoyant. He announced that the world-wide wireless system was being prepared to provide a variety of facilities, most of which we take for granted today. They included the interconnection of the existing telegraph exchanges all over the world; the establishment of a secret and non-interferable and non-interfering government telegraph service; the interconnection of all telephone exchanges in the world; a worldwide news distribution service in connection with the press; a worldwide private communication service, the interconnection of all stock tickers of the world; inexpensive clocks that required no attention yet were very accurate; the transmission of typed or handwritten characters; the establishment of a marine navigation system, and more. Much of what he described became reality within his lifetime.

Morgan's support ends

In the *Electrical World and Engineer* of March, 1904, Tesla revealed that the Canadian Niagara Power Co. had offered him inducements to locate his wireless power-transmission project at

their plant, and that he proposed to use those facilities to distribute 10,000 horsepower at a potential of 10 million volts.

The Niagara project never materialized, but may have had some influence on the fate of the spectacular Long Island project. For reasons that have never come to light, J.P. Morgan had a change of heart, and Tesla's financial fountain suddenly went dry. At first Tesla refused to believe that Morgan would not arrange for the nearly finished job's completion, but Morgan's withdrawal was abrupt and final. Historians of the industry wonder why. Did Morgan lose patience? Did engineers of high repute convince him that Tesla's visions, so openly revealed in the brochure, were nonsense, and that he was wasting his money on a hopeless dream? Did he suspect that Tesla was diverting time and money to the Niagara project? The facts will probably never be known. Tesla said, however, that Morgan "carried out his generous promise to the letter and it would have been most unreasonable to expect from him anything more." But almost in the same breath, Tesla said, "I am unwilling to accord to small-minded and jealous individuals the satisfaction of having thwarted my efforts. These men are to me nothing more than microbes of a nasty disease. My project was retarded by laws of nature. As for the tower, it was dismantled, although with considerable difficulty, for "security" reasons during World War I.

The radio-frequency alternator

As early as 1890 Tesla built high-frequency AC generators. One, which had 384 poles, produced a 10-kHz output. He later produced frequencies as high as 20 kHz. More than a decade was to pass before Reginald Fessenden developed his RF alternator, which had an output of 50 kilowatts. That machine was scaled up to 200 kilowatts by General Electric, and put on the market as the Alexanderson alternator, named after the man who had supervised the job, and who had built some of Fessenden's earlier alternators.

When it appeared that British interests (already in control of most of the world's cables) were about to acquire the patents for that machine, the Radio Corporation of America was organized at the urgent suggestion of the United States Navy. The new company was formed in 1919, around the Marconi Wireless Telegraph Co. of America, and the powerful but inefficient

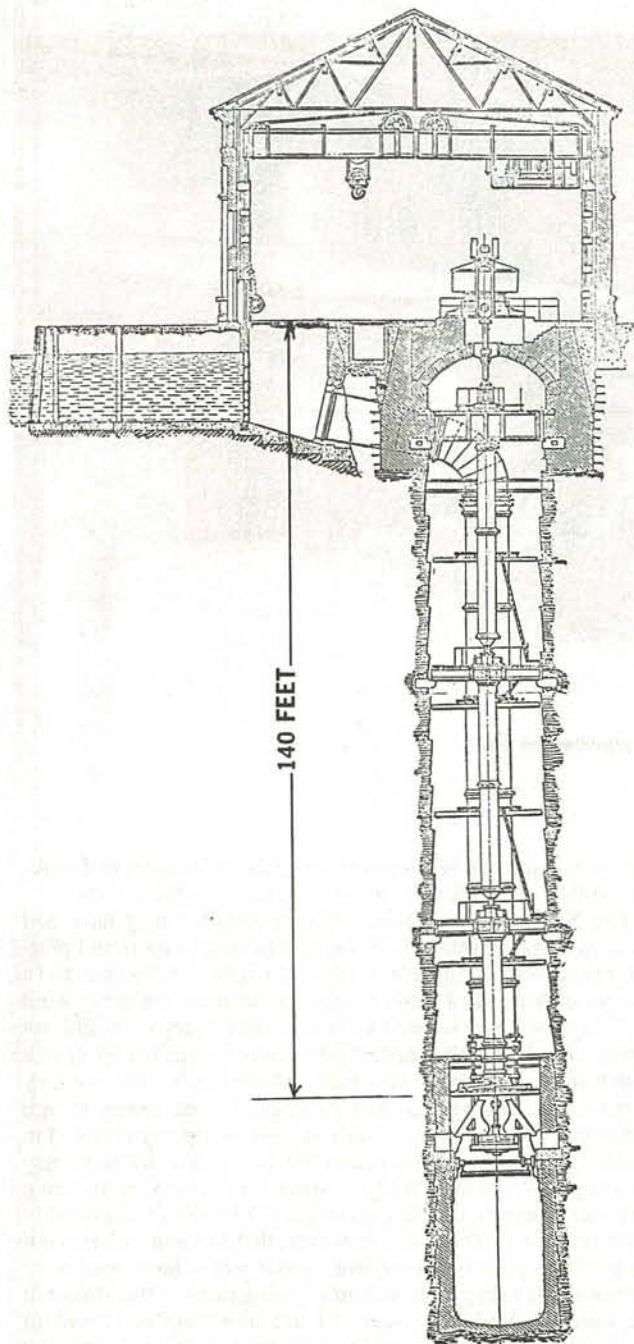

NIAGARA FALLS HYDRO-ELECTRIC power plant, the largest of its time. One of the 5000-horsepower Niagara Falls units built by Westinghouse.

Marconi spark transmitters were replaced by the highly successful RF alternators. The first one, shown in Fig. 4, was installed in New Brunswick, N.J. at station WII. It produced a 200 kilowatt, 21.8-kHz signal, and handled commercial business that previously was transmitted over cable. That was the first continuously reliable trans-Atlantic radio service. Those alternators performed so well that a whole battery of them was ordered; they were installed at Radio Central, Rocky Point, Long Island. Ironically, it would have been almost in the shadow of Tesla's tower, if that structure had still been standing.

Thus Nikola Tesla's world-wide wireless dream was fulfilled some three decades after he initiated the project, and right where he started it, using the type of transmitter he devised.

One of the giant radio-frequency alternators has been preserved in the Smithsonian Institute. That one originally served at

Author's note: I am indebted to the late Hugo Gernsback, friend and confidant of Nikola Tesla; to *Prodigal Genius*, the biography of Tesla by John J. O'Neill; to the *Proceedings of the AIEE*, and to various publications for their help and information.

trans-Atlantic transmitter station WSQ at Marion, Massachusetts.

Radar and turbines

Tesla continued active research in many fields. In 1917 he suggested that distant objects could be detected by sending shortwave impulses to them and picking up the reflected impulses on a fluorescent screen. (If that doesn't describe radar, what does?) He described cosmic rays 20 years before other scientists discovered their existence.

At various times up to 1929, he devoted his attention to a "bucketless" high-speed turbine for steam or gas. Friction between the increasingly irascible Tesla and some of those working with him on tests at the Edison Waterside power plant and in the Allis-Chalmers factory did not help his cause, but many respected engineers today agree that we have not heard the last of the Tesla turbines with their smooth rotor discs.

As the years passed, less and less was heard from him. Occasionally some reporter or feature writer would look him up and manage to get an interview. His prophecies became increasingly strange and involved, leaning toward the abstract and delving into the occult. He never acquired the habit of writing notes, always claiming (and proving) that he was able to retain complete detailed data on all his research and experiments in his mind. He said that he intended to live to 150, and upon reaching age 100, would write his memoirs, which would include a detailed record of all of the data he had compiled. At his death, during World War II, the contents of his safe were impounded by military authorities, and nothing has been heard since as to what records, if any, were there.

One of the peculiar inconsistencies of Tesla's character was revealed when two high honors were offered him, and he rejected the one but accepted the other. In 1912 it was announced that Nikola Tesla and Thomas A. Edison had been chosen to share the Nobel Prize, including the \$40,000 honorarium. Tesla could well have used the \$20,000 at the time. Nevertheless, he flatly refused to share an honor with Edison. However, when in 1917 the AIEE's Edison Medal—founded by anonymous friends of Edison—was awarded to Tesla, he was persuaded to accept it, after first refusing.

The esteemed eccentric

Tesla's natural demeanor was that of the aristocrat. With the passage of time and depletion of his resources, he sank into a condition of genteel poverty. Continuing to live in the best hotels, his credit would become exhausted and he would be forced to seek other quarters. Finally, moving into the newly opened New Yorker, he found his problems solved. Some of the organizations for which he had made millions arranged with the hotel management to take care of the aging genius.

Tesla insisted on carefully wiping each item of silverware, china, and glass before starting a meal, using a fresh napkin for each. In view of that effort to achieve perfect sanitation, it seems inconsistent that the maids reported Tesla's room to be an "unholy mess." It wasn't Tesla's untidiness they complained about—it was the pigeons! When he was not feeding them out in the park, he fed them in his room, where he left the window open so they could come and go.

The gold-plated telephone beside his bed, over which he could speak to anyone anywhere in the world without charge, was the roost of his favorite pigeon, a white one with grey-tipped wings. "When she dies, I will die," predicted Tesla. And so it was that one day in January 1943, that favored bird paid him her last visit. "She was dying," lamented the lonely, unhappy Tesla. "I got her message, through the brilliant beam of light from her eyes."

One of the maids, observing that the "Don't Disturb" sign had been hanging on Tesla doorknob for an unusually long time, used her pass key to investigate. Tesla had passed to his reward, leaving his gaunt 87-year-old frame peacefully in bed. The maid fed the mourning pigeons, gently ushered them out, and closed the window.

R-E

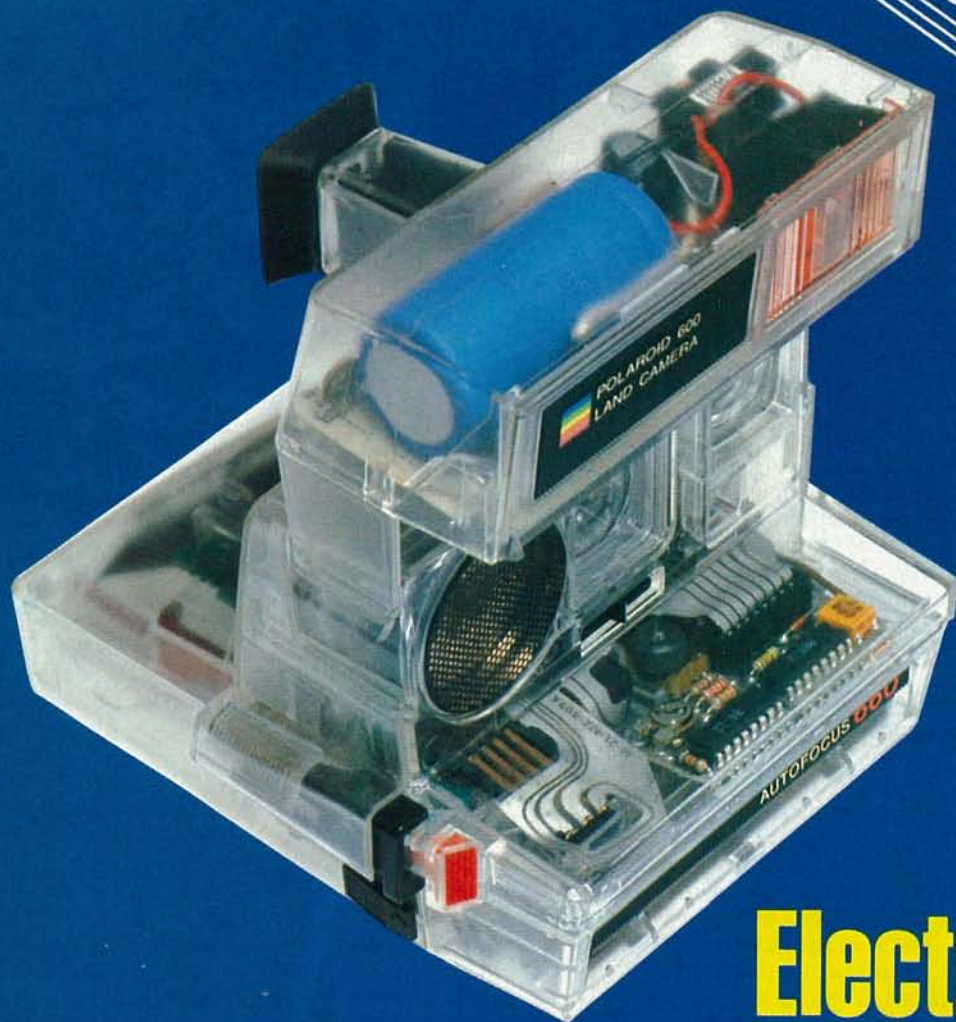

Electronics and Photography

MARC STERN

Picture taking—and all areas of photography—have benefited from the introduction of electronics into the equipment used. In this special section we'll examine some recent advances in this area.

WHILE MANY CAMERAS ON THE MARKET TODAY LOOK MUCH the same as cameras some 25 years ago, they are hardly in the same class. Cameras today are "smart." All a photographer has to do is bring the camera up to his eye and press the shutter release. No longer does he have to worry about whether a scene is too bright or too dark. Photosensors take care of reading the brightness of a scene, setting the exposure, and even activating strobe circuits if extra light is needed.

Some cameras on the market even save the photographer from worrying about focusing. Instead, using sonar or one of several infrared rangefinding-techniques, they determine the camera-to-subject distance and cause the lens to be focused for the photographer in a fraction of a second. There are cameras available from Kodak, Polar-

oid, and other companies that have this feature.

All these cameras allow the photographer what is known as "decision-free" photography, freeing him to be creative. In other words, it's point-and-shoot photography, just as in the days of the box Brownie, but now the cameras are far more sophisticated and the results are much better.

In fact, the whole picture-taking process is far simpler, because "decision-free" photography also extends into the realm of accessories. There are now light meters on the market that do virtually all the thinking for the photographer. He no longer has to spin dials or match needles; instead, a liquid-crystal display gives him all the information he needs.

It's much the same with strobe units, too. Instead of letting the photographer worry about distances, lens openings, and other factors that can affect a flash exposure, dedicated strobe units communicate directly with the camera, presenting exposure information through the accessory "hot shoe." The camera's logic circuitry handles the input from the strobe and sets the correct exposure. If a strobe is not designed to connect directly to the camera, it will present its information on an LCD display so the photographer just has to dial it in.

Further, using photosensors, the strobe will determine when it has delivered enough light, and then shut itself off.

"Decision-free" photography even extends to the darkroom, where the photographer will find microprocessor-driven enlargers that remember correct exposure settings. There are also digital color-analyzers that interface with enlargers and set the correct color-filter combinations. That leaves the photographer free to create. (For the photographer who likes more control of things, there are still manual adjustments that can override the settings determined by the microprocessor.)

How we got here

To be fair, some cameras were fairly automated a few years ago, but they still required a great deal of work on the part of the photographer. For example, light meters have been an integral part of cameras for years. However, they have usually required the photographer to handle either setting the aperture or shutter speed, or both, himself. In the late 1960's, an advanced camera might have had a match-needle system that determined the correct exposure. The photographer had to change aperture or shutter speed settings until the needle was centered. The needle was electrically actuated, but mechanically linked to the camera's aperture- and speed-setting mechanisms.

Autofocus, too, was available some years ago, but the apparatus using it was large and clumsy.

What has changed the picture? Integrated circuits. If a camera or accessory manufacturer had tried to make today's type of camera 10 or 15 years ago, it probably would have been as large as the photographer himself. However, as circuit-integration technology headed from small scale through medium- and large-scale and up to very-large-scale, more and more components could be squeezed into a single device. Today, for instance, camera manufacturers are relying on 42-pin and 48-pin flat-pack type integrated circuits to perform the information processing they need. Those circuits accept information about film and lighting conditions and their preprogrammed logic determines what actions to take.

For example, imagine that a photodiode positioned in the camera's viewfinder finds that the light level is too low for available-light photography. It therefore sends a message to the master logic-circuitry that indicates a low-light situation. The logic circuitry, after receiving the message, activates the driver circuitry for the electronic flash, and the strobe fires automatically when the shutter release is pushed. Thus, the photographer never has to think about when to use the strobe because the camera makes the decision for him. That's just one example of what goes on inside the body of a modern camera.

Imagine trying to do that with the discrete componentry of 10 or 15 years ago. The camera would have been enormous! Yet, as a look in any photo store or catalogue will tell you, many automatic cameras—some of them sophisticated 35mm

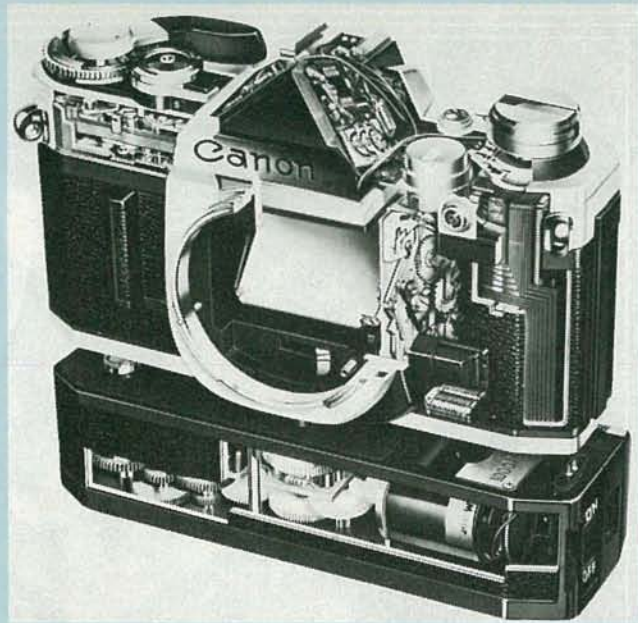

Although cameras are getting more and more complex, the electronics they contain make them easier to use than ever.

devices—are small enough to fit in a photographer's shirt pocket. If large-scale-integration techniques hadn't been used, that would have been impossible.

All-electronic photography

And, while changes have been taking place in camera and photographic accessories, the photographic medium, too, is changing. While recent developments have improved film quality while reducing the amount of silver used in making that material, silver is still expensive, and not getting any less so.

It's possible, though, that in the near future the photographer won't even need silver-halide-based film. Instead, *totally* electronic photography will take its place. The concept has been admirably demonstrated in Sony Corp.'s Mavica photographic system.

Borrowing heavily from video and recording technology—and creating quite a bit of its own—Sony has developed a completely film-free system. Its Mavica camera, a marvel of electronic technology, is very little larger than the standard 35mm film camera with which we are all familiar. But, while it looks normal enough on the outside, things are very different inside. It still uses a lens, but rather than focusing the photographic image on the film plane, the image is focused on a solid-state high resolution charge-coupled device. The resulting electrical signal is then processed and recorded on a miniature floppy disk, a miniature version of the sort used by computers.

The images stored on the disk can be viewed on a TV screen when the disk is inserted into a special player; as is the case with videotape, the pictures can be viewed instantly. Yes, it's true that you can get instant pictures from Polaroid or Kodak cameras, but you have to keep buying film for them; the Mavica's "film" can be reused.

If you decide you want to save a special photo for the family album, the Mavica system includes a printer that can make a color print on ordinary paper in five minutes. You can even send a Mavica picture by telephone; imagine how that could speed up news reporting!

Because the Mavica system is all-electronic, it may be possible in the future to integrate Mavica photos with microcomputer technology and write letters with your word processor that include pictures for Grandma.

These are only a few of the ways that electronics is affecting the world of photography. For a fuller description of what's happening, please turn the page.

R-E

The all-electronic MAVICA

Sony has developed a photographic system that does away with film completely. To do so, its engineers had to create an entirely new technology.



MARC STERN

FOR NEARLY 160 YEARS, SINCE THE DAY NICEPHORE NIEPCE exposed a piece of silver-bromide-coated glass to the sunlight and ended up with a picture of his yard, we have relied on silver-based materials for photography.

With the shortages of the last few years, we have begun to realize that natural resources are finite and will one day run out. Silver is one of those natural resources, and as it has become increasingly harder to find and process, its price has increased. That has resulted in a corresponding increase in the cost of silver-based products, including those used for photography, and has led photographic researchers to search for new ways of taking snapshots.

One of the avenues into which they have turned is electronics, and the result is in all-electronic still-photo system from Sony Corporation (Sony Drive, Park Ridge, NJ 07656) called the Mavica System.

Mavica stands for *M*AGnetic *V*ideo *C*AMERA, and it combines electronics and electromagnetic technology into a non-silver-based photographic system. First introduced two years ago, though not yet marketed, it represents a potential giant step in the history of still photography. Imagine a press photographer in the field hurrying a photo disk, not to a lab, but to a telephone, and almost instantly sending his pictures back to a newspaper or wire service.

Or, how about an amateur photographer taking pictures of a birthday party? Instead of having to send his film out for photofinishing, he can load the results of his work into a Mavipak viewer for instant viewing on a home television-set, and can then use a Mavigraph printer to produce as many prints as he

needs on the spot. In that way, party-goers can have instant souvenirs of their party.

Let's look at the basic Mavica system, beginning with the camera.

The Mavica camera

Figure 1 shows the Mavica camera. About the same size as a conventional 35mm camera, about the only thing the Mavica has in common with one is its optics. Inside, they are as different as day is from night.

Instead of using a roll of film, the Sony camera uses a Mavipak recording disk—constructed much like the floppy disks used by microcomputers—to store pictures. The image produced by the lens is focused onto the face of an integrated circuit called a CCD (Charge-Coupled Device), which converts it into electrical energy. That energy is converted into a signal that can be recorded on the magnetic disk, which is capable of holding 50 pictures.

The Mavica acts much like a video-recording system. It uses the same general principles but, instead of using a vacuum tube for image conversion, it uses a CCD. Most video terminology can be applied to it.

The CCD is an 11×12.1 -mm integrated-circuit chip with an image area of 6.6×8.8 mm. It is the heart of the Mavica system.

The resolution of the CCD is high—the image formed by it consists of an array of 570×488 pixels (a pixel is a picture element). The signal generated on the image area is sent to a storage area on the chip during the vertical blanking-interval. In

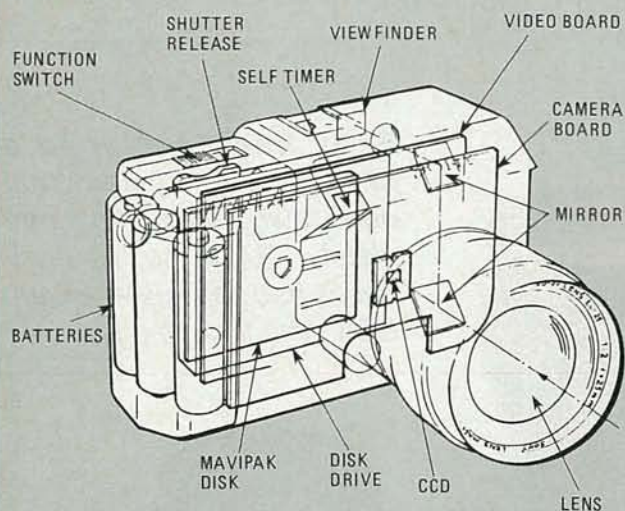

FIG. 1—THE MAVICA CAMERA is about the size of a large 35mm camera but has little in common with it save for its shape and optical system—it is entirely electronic.

response to a clock pulse, the image is then read out of the storage area into a readout register after the vertical blanking-interval. Color filtering is handled by a filter with red, green, and cyan stripes.

The Mavica's CCD was designed to take advantage of the "narrow-channel" effect—when the width of a MOS transistor electrode is narrowed to about 2 micrometers (μm), a change in electric potential can be produced across it if it is excited by light. The small size of the channels means that the CCD can have simple, densely packed, image-sensing cells. The uncomplicated geometry also means that the driving circuitry can be reduced to simple two-phase clocks, and that the power requirements are low.

With the light falling directly on the CCD unit, its spectral response (sensitivity to a wide range of colors) is high. To counteract "blooming" (image degradation caused by excess electrons spilling from one sensor cell to its neighbors), an overflow drain was added to the chip; Sony claims that the drain causes only an insignificant reduction of sensitivity.

The Mavica disk

In the standard photographic process, the storage medium is silver-halide-coated film. The film captures the image, and is later developed to make the latent image visible. However, in the Mavica system, images are recorded on a magnetic-material-coated disk, the Mavipak (see Fig. 2), which is inserted into the camera.

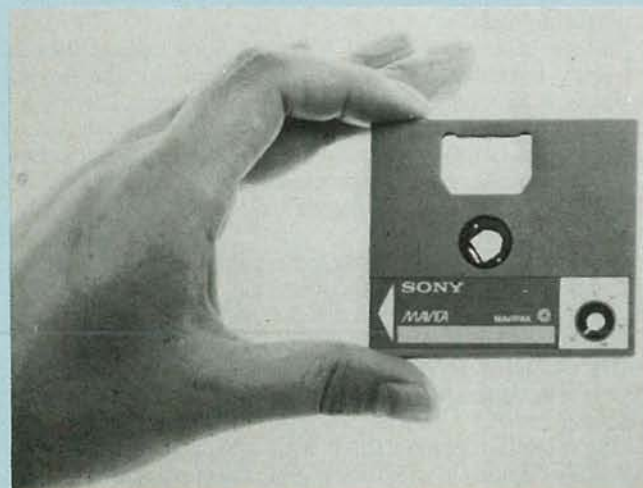

FIG. 2—THE MAVIPAK DISK measures only about two-inches square, yet can store 50 pictures.

The Mavipak is inserted into a disk-drive unit that revolves at a speed of 60 revolutions-per-second. A compact motor that is controlled by servo-circuitry ensures that the speed remains constant.

One would think that due to the high speed of the disk's rotation, there would be some stability problems, but Sony claims otherwise. Because of its small size, the disk is only minimally affected by aerodynamics or centrifugal force. Any tendency for the video disk to move away from the recording head is limited by a guide plate. Instead, because of the position of the guide plate, an air cushion is formed that helps keep the disk-to-recording head relationship constant at 0.07 micrometers as shown in Fig. 3.

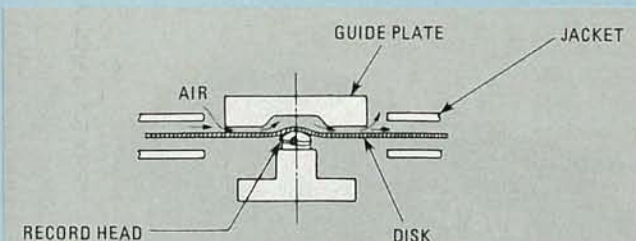

FIG. 3—A SPECIALLY DESIGNED GUIDE PLATE uses air pressure to keep the Mavipak disk in contact with the record head.

Since that arrangement ensures stability, there is no need to have other pressure exerted to bring the head and disk together, and that, in turn, ensures a considerably longer working life for the recording disk.

Head-to-track alignment is also very important, and is a must for quality picture-reproduction. If the head and track being recorded or read are not within $\pm 10 \mu\text{m}$ of one another (a lateral measurement), the signal-to-noise ratio becomes too high and quality deteriorates. However, Sony admits in published papers that that figure is hard to achieve (it has been found that temperature variations alone can cause the figure to vary by as much as $\pm 30 \mu\text{m}$) and has been accommodated for by tracking-error-correction circuitry incorporated within the playback unit.

Like a computer's floppy disk, the Mavica's recording medium is a circular sheet of thick plastic film, coated with a magnetic material. It is housed in a plastic jacket measuring about $2\frac{3}{8} \times 2\frac{1}{8} \times \frac{1}{8}$ inches, and the entire assembly weighs only eight grams (a little over $\frac{1}{4}$ ounce).

Because the magnetic Mavipak disk is erasable, it can be used over and over again.

The first image is recorded on the outermost track of the disk, with subsequent images recorded on tracks closer and closer to its center.

To keep the size of the disk small, Sony engineers had to develop a high-density recording method. To obtain the best possible magnetic characteristics, the development team turned to a ferromagnetic metal alloy—similar to that used in high-quality audio cassettes—rather than using a metal-oxide powder. That coating meant an 8-dB improvement in output level, and permitted the use of a disk half the size of a metal oxide one.

However, that development is only half the picture. To achieve true high-density recording, the surface of the disk must be extremely smooth. Smoothness helps limit modulation noise and the losses resulting from the short wavelengths used for recording. The Mavipak disk is able to boast a 0.05-micrometer peak-to-peak smoothness. The magnetic characteristics of the disk are extremely even—output level along a track varies by no more than ± 1 dB. The result of Sony's efforts is a disk that can record wavelengths of $0.8 \mu\text{m}$ —equivalent to signals with a frequency of 3.75 MHz.

Signal processing

The concepts embodied in the Mavipak system go a long way toward ensuring that picture quality will be good. But there are

other necessities, Sony has found.

To produce high-quality, reproducible images, it is necessary to have luminance and chrominance signals with good resolution and a good signal-to-noise ratio. Accomplishing that is not easy because, due to the limited space available within the Mavica, the circuitry cannot be too complex.

To keep things simple, the Mavica uses a single-track, line-sequential recording system; instead of being recorded simultaneously, the R-G and B-G signals are mixed separately with the luminance-plus-sync signal, and recorded one after the other. That, Sony admits in published technical papers, causes some deterioration in the vertical resolution of the chrominance signal. But, while the amount of deterioration is on the order of 50 percent, it is not noticeable because the horizontal resolution, determined by the one-MHz bandwidth of the chrominance signal, is still less than the vertical resolution. Other single-track recording methods were dismissed because of potential jitter problems that would have led to hue fluctuations.

The recording circuitry is pretty straightforward. When a photographer using a Mavica camera captures a scene, the image of that scene is converted by the CCD into an analog electrical signal. That signal is then broken down into four components—luminance, red, green and cyan—by sample and hold circuits. The green and cyan circuits are used to produce the blue signal and all of them are then fed to processing amplifiers.

The processing amplifiers output the processed luminance, red, green, and blue signals, with the luminance signal then being added to the sync signal and fed to a frequency modulator.

The red, green, and blue signals take a path through a matrix circuit and are then converted to color-difference (R - G and B - G) signals. From that point, the signals are selected line-sequentially and are then fed to a second frequency modulator.

The two signals are passed through low- and high-pass filters to narrow their bandwidth and are then fed to the recording amplifier. It is that final signal that is recorded on the disk.

Those functions are handled by specially developed LSI IC's and hybrid modules.

The Mavica player

The final part of the basic Mavica system is the playback unit, which converts the signals recorded on the disk into a picture that can be viewed on a television receiver. The playback head of the player is analogous to the record head in the Mavica camera. However, while the record head can only move from track to track from the outside toward the center of the disk, the playback head can move from one track to another in either direction; that allows pictures to be accessed at random.

As was mentioned earlier, the tracking error induced in the Mavica camera can be sizeable. The microprocessor-controlled tracking-error-correction circuitry incorporated in the player works by sensing where the RF signal is strongest on the disk

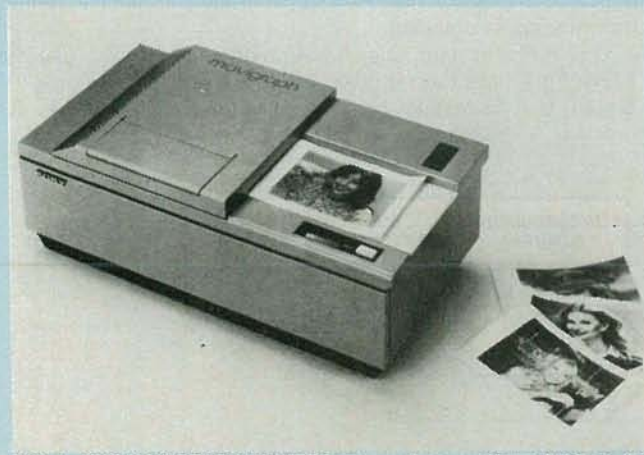

FIG. 4—THE MAVIGRAPH PRINTER can produce a color print from the Mavica or other still-video source in about five minutes.

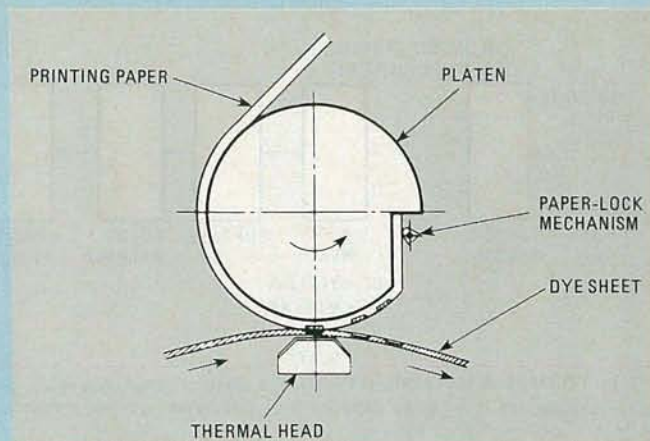

FIG. 5—IN THE PRINTING PROCESS the paper, wrapped around a platen, is brought into contact with a series of dye sheets and the thermal elements that transfer the dye to it.

and maintaining the playback head in that position.

Each track on a Mavipak disk contains one picture consisting of 262.5 video lines. That's the equivalent of one video field; two fields make up a complete video frame of 525 lines. Because the Mavica pictures are still pictures, each track is played over and over as the picture is viewed. To generate a standard full-frame NTSC video signal, several sets of delay lines are used in the player. One set takes the line-sequential chrominance information and restores it to NTSC format; one $\frac{1}{3}$.3- μ s delay line and two 63.5- μ s delay lines are used for that purpose.

To generate a 525-line picture, every other field is synthesized from the information contained in the 262.5-line recorded fields.

The horizontal resolution (the resolution in the horizontal direction—not the number of horizontal scan-lines) of the Mavica picture is 240 lines; that figure is due primarily to the number of picture cells on the CCD imaging element. The recording capability of the Mavica disk is approximately 350 lines (horizontal resolution), which means that we may see a considerable improvement in picture quality in the future.

The Mavica printer

Although the Mavica system represents a breakthrough in "filmless" photography, it would be of little value if it were limited only to viewing photos on a television receiver or monitor. Recognizing that, Sony has also developed the thermal color video printer shown in Fig. 4.

It is capable of taking the color output-signals from the Mavica—or any other color-video system—and turning those signals into color prints. It can accept either composite-video or RGB (Red-Green-Blue) signals.

The Mavigraph, as the printer is called, uses a thermal dye-transfer system. As shown in Fig. 5, a sheet of paper—which can be ordinary writing paper, although a special polyester-coated type gives better results—is wound over a platen. A thermal printing-head is pressed against the platen so the paper and a sheet of material containing dye come into contact with each other. As the platen and the printing paper turn together, the dye sheet is drawn at the same speed over the printing head. The intensity of the heat produced by the print head—which determines how much dye will be evaporated and transferred to the paper—is controlled by the level of the video signal.

Four colors are used in the printing process: yellow, magenta, cyan, and black (these are the same colors used to print the covers and color pages of this magazine); they are the printing equivalents of the video signal's blue, green, red, and black, respectively. Each color is contained on a separate dye-sheet, and the colors are transferred sequentially, in the order indicated above. First, the entire yellow portion of the print is produced. Then the platen carrying the paper returns to its original starting position and the magenta portion of the print is laid down...and

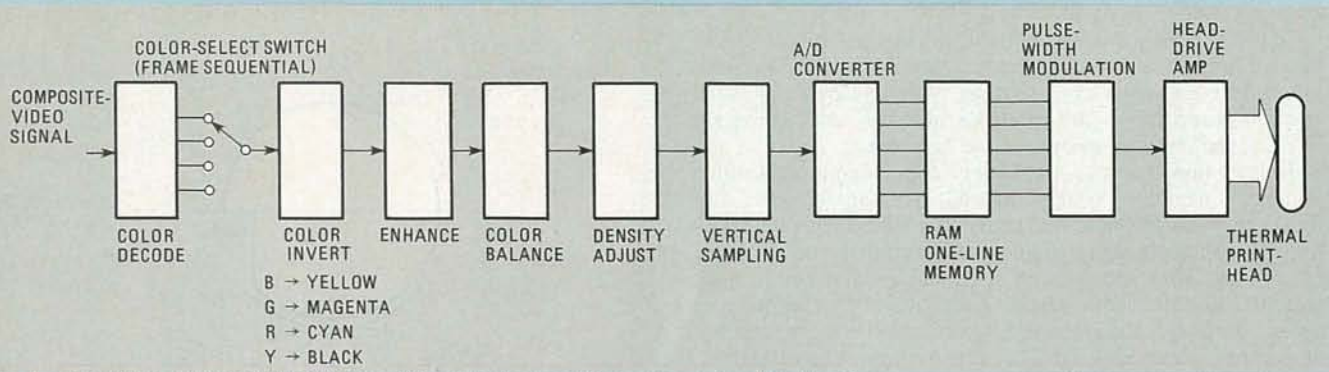

FIG. 6—TO MAKE A MAVIGRAPH PRINT, the video chrominance (blue, green, and red) and luminance signals are inverted to produce their opposites—yellow, magenta, cyan, and black.

so forth. For black-and-white prints, only the black dye-sheet is used. The flow of the printing process is illustrated in Fig. 6. In some versions of the printer, the dyes are contained, one after another, on a single piece of material wound into a roll. The finished print is laminated in plastic both for protection and to enhance the image.

The printer scans the video image vertically—from top to bottom across the scan lines—rather than horizontally (along the scan lines) as you might expect, and the picture is reproduced on paper from left to right. It takes about five minutes for a complete print to be produced.

The thermal print head used in the Mavigraph contains a row of 512 elements—four per millimeter—to produce a picture measuring $4\frac{3}{4} \times 6\frac{1}{2}$ inches. The compactness of the print head is due to 16 special IC's, each of which contains a 32-bit shift/store register and 32 drivers.

The Mavigraph can be used to produce any number of color prints of a still picture taken by a Mavica or a video camera, or of a single frame or field of an image displayed by any video device, including a television receiver, computer, or VTR.

A home-video camera can be used to convert existing color film negatives or positives into video signals suitable for reproduction by the Mavigraph. The fact that the amounts of red, green, and blue in the print can be controlled allows the Mavigraph user to adjust the color balance of his prints to his taste, and to experiment with unusual color-effects. Sony expects to open an entirely new market for the combined use of conventional photography and electronic Mavigraphy.

This printer and the system it supports have been termed a new era in video technology that adds a new dimension to video. For instance, the system can be used to produce hard color-copies from signals received from teletext or videotex systems. It can also be used as an image printer for an x-ray machine, CAT scanner, or other medical equipment. It can even serve as a terminal printer for office computers and as a color facsimile printer.

How will that be done? Sony's engineers have done some thinking about the matter, and have come up with a system they believe will work. It's much like an amateur radio slow-scan television setup, except that it works via telephone.

Photos by phone

Settling on transmission using amplitude modulation, the Sony engineers designed a system (the receiving end of which is illustrated in Fig. 7) that links a transmitting unit and a receiving unit via phone circuits. The system also includes memory storage-devices because of the transmission-time constraints imposed upon it by the phone system.

It takes about $63 \mu\text{s}$ to display one horizontal line on a TV screen. However, because of the telephone system's limited bandwidth, it takes about 400 ms for the information contained by that same line to be transmitted over a telephone line. That means that some sort of memory buffer must be used to store and transmit each line as the system can handle it. A similar situation holds at the receiving end, except that the entire picture is captured in the receiver's buffer. As each line is received, it is read out, along with the lines that have already preceded it into the buffer, and becomes part of an image displayed on the receiving television set's screen via high-speed video processing circuitry.

Since the system uses voice-grade telephone lines, the analog signal transmitted must be able to fit within the restrictions they impose. The engineering team looked at the various means of modulation—amplitude, frequency, and amplitude-phase—and decided to use double-sideband AM for reliability.

The engineers also had to keep the system's maximum bandwidth in mind when defining their parameters. Using a maximum range of 300 Hz to 3400 Hz as boundaries, Sony's engineers chose an 800-Hz image frequency and a 1500-Hz carrier frequency for best transmission quality, recognizing not only the limitations imposed by the phone system, but also the potential for fluctuations in level, for line noise, and for system leakage.

The video output of the Mavica is sampled at a rate of about 14 MHz and digitized. The digital information is read into memory and is then read out at a much slower rate—2.2 kHz. After digital-to-analog conversion, a signal suitable for telephone-line transmission is obtained.

One problem with magnetic-reproduction devices (like the Mavica playback unit) is jitter. While it is not apparent on a TV screen, it is something better done without. To eliminate the

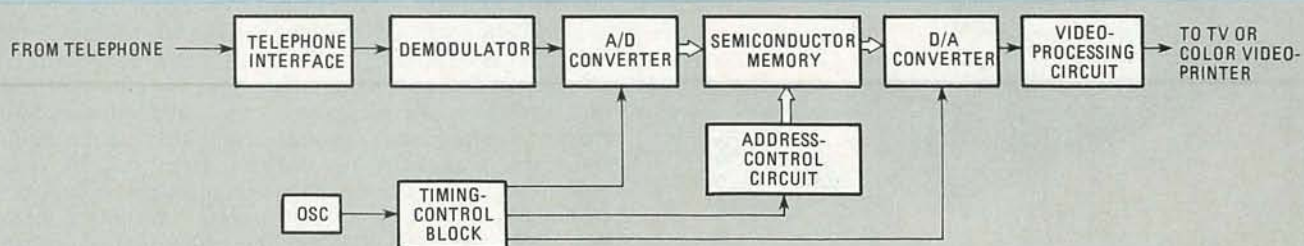

FIG. 7—THE TELEPHONE-LINE RECEIVER converts the slow incoming analog information to digital form so it can be stored, then converts it back to a high-speed analog signal for display.

continued on page 78



The New Disc Cameras

In this article we'll look inside Kodak's new disc camera—a good example of how electronics have made the picture-taking process easier than ever.

MARC STERN

THE EARLY ADVERTISING CLAIM OF EASTMAN KODAK, "You push the button; we do the rest!" is now more true than ever. When Kodak was designing their new disc camera, their intention was to develop a decision-free photo system. And thanks to the miniaturization allowed by the continuing advances in microelectronics, that camera maker has been able to produce small but sophisticated snapshot cameras that allow the photographer to simply aim and shoot. While other camera manufacturers have followed Kodak and are producing their own disc cameras, we will discuss only those from Kodak.

What are the features of the disc cameras? There are four models from which to choose: the 3000, 4000, 6000, and 8000. Essentially the four models are the same, but they differ in some features and, of course, price. (The models' price range is from \$56.95 to \$142.95.) Let's first look at the features that all models have in common; then we will look at the differences.

Each model has a 4-element, $f/2.8$, 12.5-mm, fixed-focus (four feet to infinity) lens. Each also has two automatic exposure settings. The flash is built in and operates automatically when

needed. Without the flash, pictures can be taken every 0.4 seconds. With the flash, that increases to about one second, due to the flash-capacitor charging time. There is no exposure indicator needed and the film advance is automatic. Needless to say, all four models use disc film.

Now that we've seen the similarities, let's look at the differences between the four disc camera models. First, we'll look at "extra" features. Both the 6000 and 8000 have a close-up lens (18 inches to 5 feet) that is simply slid (with a lever) in front of the normal lens. A close-up indicator is seen in the viewfinder when that lens is chosen. All of the models have a metal carrying strap, but the 6000 and 8000 also have a protective handle/cover that covers the entire front of the camera. (It can also be used to stand the camera up.) Only the 3000 is not powered by two 3-volt lithium batteries. Instead it uses a replaceable 9-volt alkaline battery. In the other models, the lithium batteries are considered to be an integral part of the camera and, as such, are covered by the five-year warranty.

The 8000 has three features that none of the other models have: a motor drive that permits rapid firing by holding down the shutter button; a 10-second self timer (with flashing LED and audible beeper), and, located in the cover, a digital alarm clock with its own power supply.

Nothing could be easier

Before we look at the electronics inside of the Kodak disc cameras, let's take a look at how you would operate one of them. The first step, of course, is to load the film. The film-loading

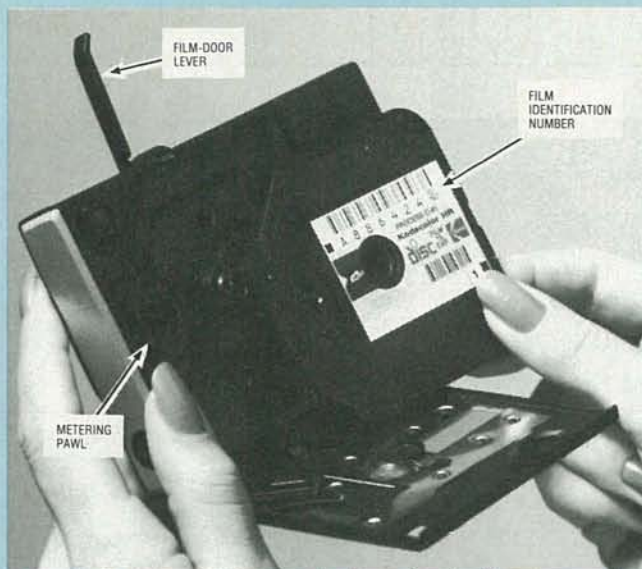

FIG. 1—THE DISC CAMERA might be the easiest-loading camera yet.

process consists of lifting a lever which locks and unlocks the camera door, then dropping the disc film in place, as shown in Fig. 1, and then closing and locking the film door.

That is a pretty simple method of doing things, and the film can be inserted in only one direction. However, that simple action launches an intricate interplay between camera and film as a complex locking and disc-engagement sequence begins. When the disc is inserted into the camera, teeth on the core of the film disc engage lugs in the camera. Those lugs drive the film and work in conjunction with notches in the film and a *metering pawl* in the camera to automatically position individual negatives for exposure.

Locking the camera door actuates a lever in the camera which rotates the disc's *dark slide*. That slide protects the undeveloped film from light. When the camera is opened, the dark slide is swung back into its protective, locked position.

With the camera ready for action, the photographer opens the lens cover, places the camera to his eye, looks through the viewfinder, and presses the shutter button.

Decision-making electronics

We could say that it is at this point that the electronics developments enter the picture. But that's not really true. Actually, the electronic process is initialized when lens cover or the cover/handle is opened, or when the shutter button is lightly touched. Those actions "wake up" the camera's electronics and start the charging of the flash-capacitor.

The major portion of the disc camera's electronics is contained in two custom IC's—the *light-sensing IC* and the *control IC*. Those IC's and the rest of the camera's circuit board is shown in Fig. 2. We'll look closer at those two IC's in a little while. First, though, let's take a look at what they and the rest of the electronics do.

Figure 3 is a simplified flowchart of the camera operation. Although we would like to show the complete decision-making process, that flowchart is simply too big. Also, the flowchart for the model 8000, because it contains a rapid-sequence mode and a self timer, is quite complex. Therefore our simplified flowchart does not cover the 8000. Also, to avoid confusion, we will say here that for the rest of the article, unless we specify otherwise, we will be referring to the model 4000.

The electronic process begins when the lens or camera cover is opened. When that happens, switch S1 in the camera is closed, and power is applied to the circuit board. (Figure 4 shows some of the camera's switches and their locations and Table 1 lists the functions of those switches.) That starts the "wake-up" routine and initializes the DELAY 8 routine. (That is one of several delay times that are used by the camera in its

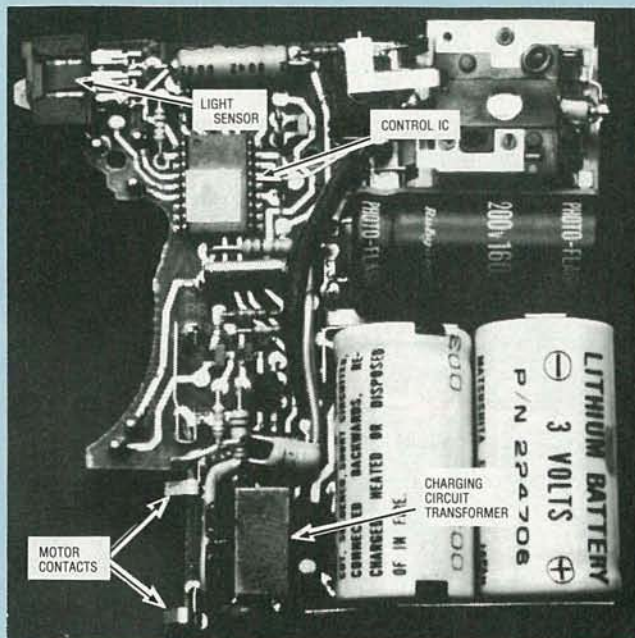

FIG. 2—COMPONENT SIDE of the disc camera's circuit board.

TABLE 1

Switch	Function
S1	Power switch. Actuated by camera cover or lens cover.
S2-a	Soft-touch shutter switch. Starts wake-up.
S2-b	Shutter switch. (Shutter button must be fully pressed.) Starts picture-taking cycle.
S3	Synchronizes flash with opening of shutter.
S4	Tells control IC when film advance should start and stop. This switch is open when the metering pawl is extended (in a film perforation).
S5	Works in conjunction with S4 to tell control IC when the film is finished.

decision-making process. All of the delay times are listed in Table 2; their function will become clear as we discuss them.) The DELAY 8 routine is the maximum time allowed for a camera cycle to occur. After that time, the camera will automatically go into its battery-conserving "doze" mode. For example, if you push the shutter button with no film in the camera, the motor will run for only 2.4 seconds. As you can see from the flowchart, the 18-pin Kodak-designed control IC is also activated (S1 is closed) whenever the shutter button is lightly touched.

We should take some time here to talk about the shutter switch. The contacts for that switch can be seen in Fig. 4. Unlike

TABLE 2

Delay time	Function	Model 4000 6000	Model 8000
1	Delay for measuring exposure	10 ms	12.8 ms
2	Maximum time to top-off flash charge	716 ms	1 sec
3	Protects against S4 bounce	3.36 ms	3.36 ms
6*	Self-timer: 1-second interval for beeper/flashing LED	—	7.37 sec
7	Total time for self timer	—	9.83 sec
8	Maximum time allowed for picture-taking cycle	2.4 sec	3.2 sec

*Delay-times 4 and 5 are not presently used by Kodak.

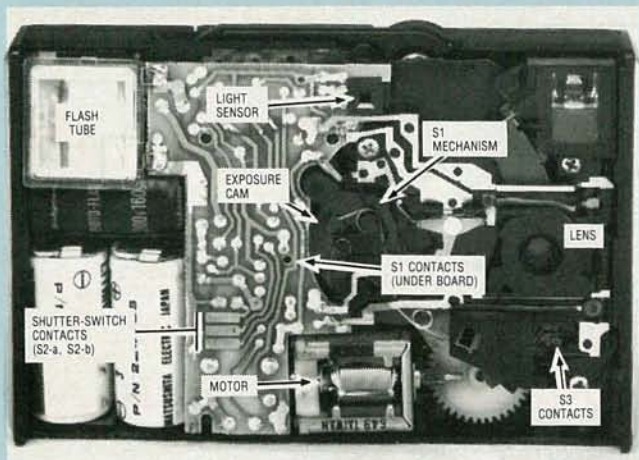

FIG. 4—THE DISC CAMERA consists not only of electronics. Various mechanical sensors are essential for its operation. Don't open your disc camera to look at them, though. First, you will probably damage the camera and void your warranty. Second, you might damage yourself—the flash capacitor is a very real shock hazard.

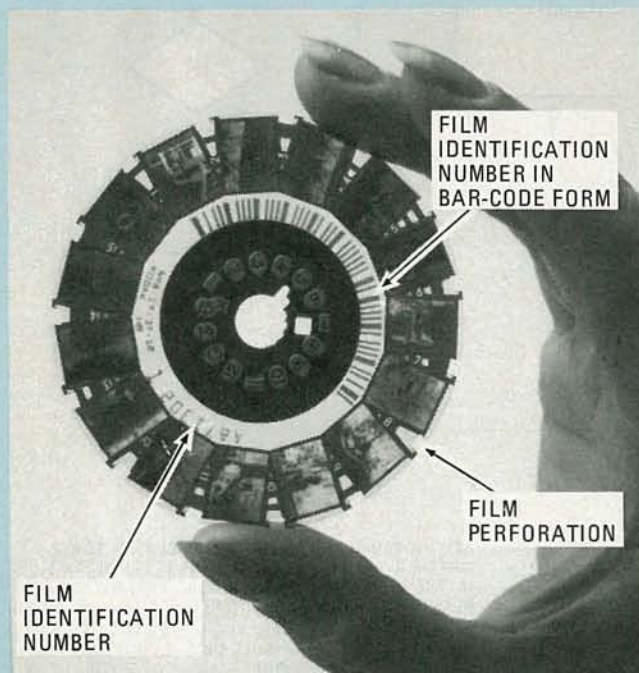

FIG. 5—A DEVELOPED FILM DISC. Note that each frame is numbered. That makes ordering reprints very easy.



FIG. 6—THIS CONSOLE lets the operator encode information in the disc's magnetic core. That information can be read automatically by special printers.

the shutter. The last thing that the exposure cam does in its cycle is to pull the metering pawl out of the perforation in the film. That is important—as you can see in the flowchart, when the pawl is out of the film perforation, the control IC knows that the picture has been taken. It then orders the motor to turn counterclockwise to advance the film.

If the light level is below 125 footlamberts, then the light-sensing IC sends that information to the control IC. That initiates another series of actions—the low-light mode. First the charge on the flash capacitor is checked until either the charge is sufficient or until DELAY 2 has timed out. Then the charger is turned off and the motor is turned counterclockwise. This time, however, turning the motor counterclockwise does not advance the film because the metering pawl is still in one of the film perforations. Instead the counterclockwise motion of the exposure cam sets the shutter speed to about 1/100 of a second and opens the aperture of $f/2.8$. Next the control IC looks at S3. That switch is closed whenever the shutter opens and is used to trigger the flash.

After the picture

After commanding the motor to turn, the control IC checks S4. (Remember, the last thing that the exposure cam does in its cycle is to pull the metering pawl out of the film perforation. That closes S4.) When that switch closes, it indicates that the picture has been taken. The control IC then turns off the charger and drives the motor counterclockwise to advance the film.

Two custom IC's

As we mentioned previously, the major portion of the camera electronics is contained in two Kodak-designed custom IC's. Let's look first at the control IC.

The control IC is an LSI integrated-injection logic (I^2L) integrated circuit. That type of logic was used because it allows combining both power and logic control on the same device. (About one half of the chip's area contains power transistors.) When the camera's motor is running, the control IC's output drivers can sink up to two amps and dissipate over 1.5 watts. On the other hand, when the camera is in its doze mode, the IC uses only 90 microwatts. If a more familiar approach, such as CMOS technology, was used, both power control could not have been included on the single IC. Thus, using I^2L helps keep costs, size, and power consumption to a minimum.

The control IC contains an on-chip voltage regulator. That's necessary because during the picture-taking cycle, the battery voltage varies (from 2 to 8 volts) as the motor is used. Also on the chip is a 10 kHz clock. As you can see from our discussion on the delay times, that clock, plays a very important role in the decision-making process of the disc cameras. In the 8000, it also controls the self-timer. That includes flashing an LED and pulsing a beeper—and doubling the flashing/pulsing frequency about 2.5 seconds before the exposure.

The light-sensing IC measures the ambient light level and sends a one-bit output to the control IC to tell it whether or not the light level is over 125 fL. The photometer and the threshold-detection circuitry are on the same chip. That helps to reduce the chance of electrical noise causing an error.

The clock in the control IC and the detect circuitry in the light-sensing IC are both *wafer calibrated*. That means that the chip is modified while it is still in wafer form. That helps to reduce costs because it eliminates the need for further calibration in the camera. It also helps to achieve better quality control.

Once you've finished taking the pictures, the electronics processes don't stop—they continue during the photofinishing process. On each film label and on the disc itself (see Fig. 5) is a bar code pattern called the film identification number or FID. And the film core is magnetic—styrene impregnated with iron oxide. That means that instructions can be recorded there to be read by special photofinishing equipment. Figure 6 shows a console that prepares disc negatives for reorders. Reprint quantities, frame number, and even color/density corrections can be recorded on the film's magnetic core. **R-E**

Auto exposure and Auto focus Systems

Autofocus and auto-exposure systems have revolutionized modern photography. In this article we'll look at those systems and see how they've made picture taking simpler than ever imagined.

MARC STERN

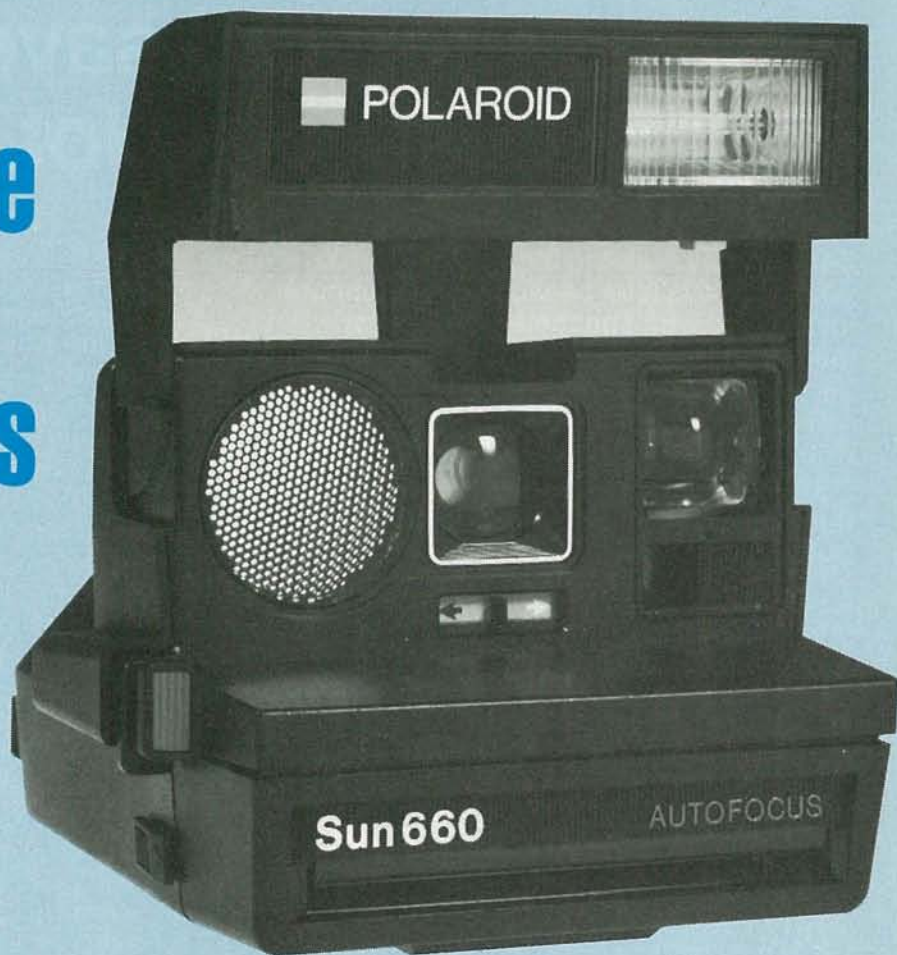

HAVE YOU EVER STOPPED TO THINK ABOUT HOW PHOTOGRAPHY has changed over the past few years? For one thing, taking a picture, even under adverse conditions, has become simpler than ever. Powerful electronic circuits provide so much control over the various camera functions that essentially all a photographer has to do is focus and shoot. And, with some cameras he doesn't even have to focus; that chore is handled for him by an autofocus system.

All this has been made possible by the microelectronics "revolution" and the resulting development of LSI (Large-Scale-Integration) techniques. Using LSI technology, camera manufacturers have been able to combine many control functions on a single IC. The result is a generation of "cameras that think."

Highly sophisticated electronics can be found in everything from "simple" snapshot cameras to professional photographic equipment. One example of the state of the art in 35mm photography is the Minolta (101 Williams Drive, Ramsey, NJ 07446) X-700 system. It offers just about every camera feature currently available and consists of the camera itself, an autoflash, a motor drive, a multifunction back, and a wireless remote control. We'll discuss those accessories shortly, but first let's look at what makes this camera so special.

The X-700, shown in Fig 1, features a new faster-speed-priority program-mode, plus an aperture-priority auto mode and a metered/full-manual mode. Those modes allow a photographer the choice between automatic and manual picture taking.

In the program mode, the camera automatically selects both aperture and shutter speed for the best exposure. The system

logic is designed to maintain the fastest possible shutter speeds as light dims. If the shutter speed will be $\frac{1}{30}$ second or slower, the camera will give an audible signal (assuming that feature is switched on) to warn the photographer that blur from subject/camera movement is possible.

In the aperture-priority auto mode, the photographer sets the aperture manually and the camera automatically sets the best shutter speed.

In the metered/manual mode, the photographer can take advantage of the X-700's through-the-lens center-weighted averaging meter system, while maintaining full manual control over the exposure setting. When using that mode, both the shutter-speed and the aperture can be varied to achieve any desired effect.

All important information is displayed in the viewfinder. Simply placing your finger on the touch-sensitive shutter release begins metering and activates all of the viewfinder displays; the displays remain active for 15 seconds, or for however long your finger remains on the button.

In the program mode, a green "P" lights in the viewfinder above the shutter-speed scale. Red LED's along the shutter-speed scale indicate which shutter speed is being set by the camera. Because the shutter-speed settings are stepless, if two LED's light, the shutter speed is between the two indicated values. The minimum aperture of the lens you are using appears in the aperture window at the bottom of the viewfinder (that is not necessarily the aperture at which the picture is taken). The lens should be set at its minimum aperture in the program mode. If it is not, or if a non-Minolta MD-type lens is used, the green "P" in the viewfinder will flash. That indicates that the cam-

"I built this 16-bit computer and saved money. Learned a lot, too."

Save now by building the Heathkit H-100 yourself. Save later because your computer investment won't become obsolete for many years to come.

Save by building it yourself. You can save hundreds of dollars over assembled prices when you choose the new H-100 16-Bit/8-Bit Computer Kit – money you can use to buy the peripherals and software of your choice.

H-100 SERIES COMPUTER SPECIFICATIONS:

USER MEMORY:
128K-768K bytes*

MICROPROCESSORS:
16-bit: 8088
8-bit: 8085

DISK STORAGE:
Built-in standard
5.25" disk drive,
320K bytes/disk

KEYBOARD:
Typewriter-style,
95 keys, 13
function keys,
18-key numeric pad

GRAPHICS:
Always in graphics mode.
640h/225v resolution;
up to eight colors
are available**

COMMUNICATIONS:
Two RS-232C Serial
Interface Ports and
one parallel port

DIAGNOSTICS:
Memory self-test
on power-up

AVAILABLE SOFTWARE:
Z-DOS (MS-DOS)
CP/M-85
Z-BASIC Language
Microsoft BASIC
Multiplan
SuperCalc
WordStar
MailMerge
Data Base
Manager
Most standard
8-bit CP/M
Software

The H-100 is easy to build – the step-by-step Heathkit manual shows you how. And every step of the way, you have our pledge – "We won't let you fail." Help is as close as your phone, or the nearest Heathkit Electronic Center.

And what better way to learn state-of-the-art computing techniques than to build the world's only 16-bit/8-bit computer kit? To run today's higher-speed, higher-performance 16-bit software, you need an H-100. It makes a significant difference by processing more information at faster speeds.

Dual microprocessors for power and compatibility. The H-100 handles both high-performance 16-bit software and most current Heath/Zenith 8-bit software.

Want room to grow? The H-100's standard 128K byte Random Access Memory complement can be expanded to 768K bytes – compared to a 64K standard for many desktop computers.

And the industry-standard S-100 card slots support memory expansion and additional peripheral devices, increasing future upgradability of the H-100.

High-capacity disk storage, too. The H-100's 5.25" floppy disk drive can store 320K bytes on a single disk. The computer also supports an optional second 5.25" and external 8" floppy disk drives. And an optional multi-megabyte internal Winchester disk drive will be available in the near future.

*128K bytes standard. ** Optional.

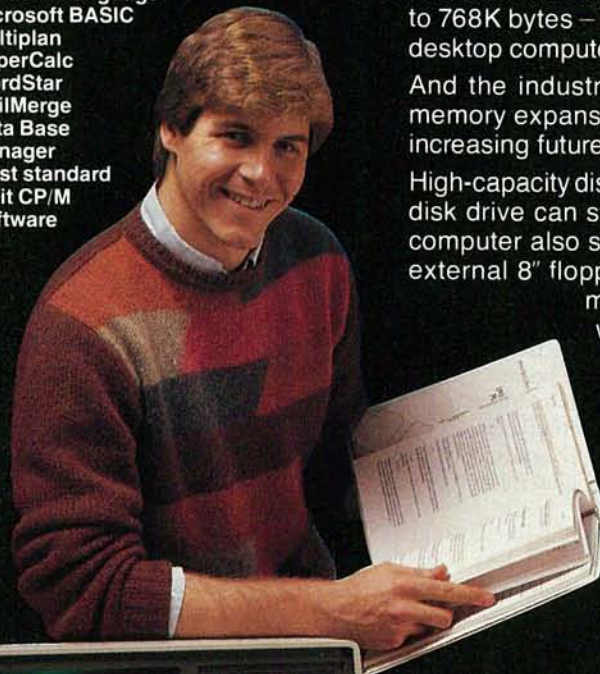

The H-100 gives me the most for my computer dollar!



Critical circuits are pre-assembled, making the H-100 easier and faster to build!

Want beautiful high-resolution graphics? You can create extensive charts, drawings, graphs and symbols to meet your needs – using the H-100's bit-mapped graphics and its 640 x 225 pixel video display.

The H-100 gives you total communications flexibility. Three interface ports let you plug in dot-matrix and letter-quality printers, as well as other peripherals.

Compare the H-100's exceptional capabilities with other desktop computers:

COMPUTER:	Heathkit H-100	IBM Personal Computer	Apple III
MICROPROCESSORS:			
16-bit:	8088	8088	—
8-bit:	8085	—	6502
RANDOM ACCESS MEMORY:			
Minimum:	128KB	16KB	128KB
Maximum:	768KB	576KB	256KB
FLOPPY DISK STORAGE:			
Per Diskette:	320KB	320KB	140KB
Maximum Internal:	640KB***	640KB	140KB
8" Floppy Support:	Standard	—	—
EXPANSION SLOTS:	Five S-100 (four available)	Five (three available)	Eight
I/O PORTS:			
Parallel:	1	Optional	—
Serial:	2	Optional	1
VIDEO DISPLAY:			
Line Columns	25 x 80	25 x 80	24 x 80
Pixels Colors	640 x 225 (8 colors)	640 x 200 (2 colors) 320 x 200 (4 colors)	560 x 192 (16 colors)
OPERATING SYSTEMS:	CP M-85, Z-DOS (MS-DOS)	CP M-86, PC-DOS (MS-DOS) UCSD P-System	Apple SOS

Information current as of 8/31/82. ***External disk storage available soon.

Learn by building. When you build and operate the H-100, you learn more about this sophisticated computer system and its unique 16-bit/8-bit software capabilities.

Learn from outstanding documentation. One of the most important parts of any computer system is documentation – and Heathkit documentation is among the industry's best. Our instruction and operating manuals are fully detailed, in the world-famous Heathkit tradition.

Learn by doing. Many of our software programs come with a complete set-up and operating manual. More complete than most other software documentation, each manual not only tells you what the program will do – it shows you the easiest way to accomplish each task.

We back you all the way. With Heathkit computer products, technical assistance and expertise is as close as your telephone – or the nearest Heathkit Electronic Center.† Complete technical assistance and service is available at over 60 locations nationwide.

Buy from a leader. When you choose a Heathkit computer, you get the backing and reliability of the world's leader in quality electronic kits for over 50 years! You can count on us for quality, service, reliability and value – at kit prices that give you more computer for your dollar!

See the H-100 in action. Visit your nearby Heathkit Electronic Center, which



Always in graphics mode, you can control each of the H-100's 144,000 screen dots! (Color graphics optional)

has the world's first 16-bit/8-bit computer kit, peripherals and software programs on display. See your telephone white pages for the nearest store location. Or mail the coupon today for a FREE, full-color Heathkit computer catalog.

CLIP COUPON AND MAIL TODAY TO:

**Heath Company, Dept. 320-084
Benton Harbor, MI 49022**

Please send my FREE Computer Catalog, with details on the new 16-bit/8-bit H-100 Computer Kit, today!

Name _____

Address _____

City _____ State _____

CP-218R1 _____ Zip _____

†Heathkit Electronic Centers are units of Veritechnology Electronics Corporation. Heath Company and Veritechnology Electronics Corporation are subsidiaries of Zenith Radio Corporation. Prices, product availability and specifications are subject to change without notice.

Heathkit
Heath
Company



FIG. 1—THE MINOLTA X700 represents the ultimate in autoexposure technology and flexibility. It features a program mode in which both the aperture and the shutter speed are determined by the camera, an aperture-priority automatic mode, and a fully metered manual mode.

era's range is reduced, and brighter subjects can not be accommodated. New Minolta MD lenses can be locked at their minimum aperture.

Similarly, a red "A" lights above the shutter-speed scale to indicate when the camera is set in the aperture-priority automatic mode. Once again, LED's light along the scale to show which shutter speed is being set by the camera. The lens aperture that you select is clearly visible in the window at the bottom of the viewfinder.

In the metered manual mode, a red "M" lights in the viewfinder, the aperture setting is shown at the bottom of the viewfinder, and an LED lights next to the shutter speed that will provide proper exposure according to the light metered through the lens. Note that this is not the actual shutter speed; both the aperture and the shutter speed must be set manually, and either setting can be adjusted without affecting the other, affording maximum flexibility.

The camera also has two features that allow for more creative control and better results when using automatic exposure-setting under unusual lighting conditions. The $\pm 2EV$ exposure adjustment allows you to vary the automatic exposure setting up to more or less two *f*-stops from normal in the program and automatic modes. When that feature is used, a \pm LED blinks in the viewfinder. The auto-exposure lock feature is useful when the subject makes up but a small part of the total picture. It is especially useful, for example, if your subject is in the shadows but his background is strongly lighted. Normally, the camera would be "fooled" and set its exposure by the bright light—but not with the auto-exposure lock. When that feature is used, the subject is metered at close range and the AE-lock switch is pressed down. While that switch is held down, all you have to do is move back, recompose the picture, and then release the shutter.

In-the-viewfinder indicators of the status of the autoflash are also displayed when that unit is attached. Among the information available is whether the flash is fully charged, insufficiently charged, or off. In the last two cases, the settings for the ambient light conditions are displayed and, if the shutter is released, those are the settings at which the camera will operate. Once the shutter has been released, another in-viewfinder indication shows if the proper exposure has been made.

What's inside

The Minolta X-700 uses five integrated circuits. At the heart of the camera is a 32.768-kHz oscillator that provides 1/30,000-second accuracy. The output from that oscillator feeds a 42-pin CMOS IC that controls the timing of most of the camera's functions. Those functions include shutter release, aperture

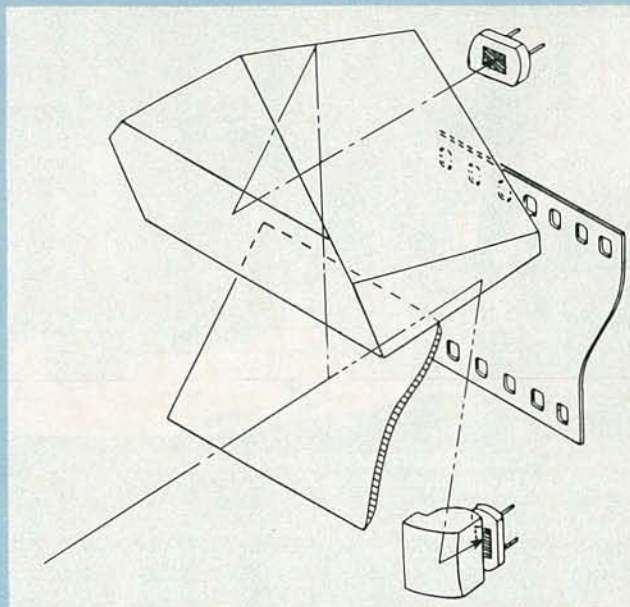

FIG. 2—TWO PHOTOCELLS are used for metering. One, on the camera's pentaprism, measures ambient light. The other, located next to the mirror box, is used for direct autoflash metering.

stopdown, and mirror lift. A 42-pin BiMOS IC handles metering, calculations, and controls. Metering is done through two silicon photocells. One of them, on the camera's pentaprism, measures ambient light, while the other, located next to the mirror box, is for direct autoflash metering (see Fig. 2). The output from the photocells is fed to the BiMOS IC, which amplifies and processes the signal. Of the remaining IC's, a 42-pin bipolar device handles mode selection and program-mode operation; a 44-pin I²L (Integrated Injection Logic) dot-display driver handles the viewfinder displays, and a 12-pin bipolar device handles the electromagnetic shutter release and power control.

To better appreciate all of the complex functions that this control system must handle, let's take a closer look at all the steps involved in producing a successful photograph. To keep things as simple as possible, we'll only look at what happens in the program mode.

As we said earlier, in the program mode the camera sets both the aperture and shutter speed, with preference given to using the fastest practical shutter speed. Touching the camera's touch-sensitive operating switch inputs preset camera-setting information and scene brightness into the program-mode circuitry. When the operating button is fully depressed, the camera retrieves a programmed aperture value from the camera's memory based on that information. The aperture is then set, and the light passing through the aperture is re-metered as a final check before shutter operation; sensitive metering and fast reaction time allows the settings to change instantly with changing light conditions. All of that happens in milliseconds.

The camera's electronics also control the flash, when that unit is required. When the flash capacitor is fully charged, a signal is fed from the flash unit to the camera. When the shutter is released, the shutter speed is automatically reset to 1/60 second and the appropriate aperture is determined. After the mirror lifts, the flash emits light simultaneously with full shutter opening so that light reflected from the subject strikes the film surface. The silicon photocell next to the mirror box collects a sample of that reflected light and shuts off the flash at the precise moment for best exposure. A feedback system indicates both in the camera's viewfinder and on the back of the flash whether the exposure was correct.

Accessories

The Minolta X-700 system includes all of the accessories you would expect to find in such a camera system, and more (see



FIG. 3—ACCESSORIES for the X-700. Of particular interest are the dedicated flash, the multifunction back, and the remote-control set.

Fig. 3). Aside from the wide variety of lenses, motor drives, etc., those accessories include an automatic flash, a multifunction back, and a wireless remote control. We'll next look at those three units and see what makes them special.

We've already looked at the *Electroflash 280PX* autoflash unit a bit. It is a clip-on programmed/automatic/manual flash unit with special contacts for both camera control and through-the-lens, off-the-film flash metering. The flash duration varies between 1/50,000 and 1/1,000-second, depending on light conditions. No adjustments or settings are made on the flash unit itself because that unit receives all needed information, including the speed of the film being used, from the camera.

Perhaps the most interesting accessory for the camera is a unique multifunction back. Containing its own dedicated processing unit, that device mounts in place of the X-700's regular back. What makes it so interesting is that it offers camera-control modes for time-lapse photographs, timed long-exposures, and multi-frame sequences. In addition, it features six data-imprinting modes to be used for identifying and classifying photographs.

A highly accurate quartz clock and auto calendar that runs from 1981 through 2099 imprint the time in hours, minutes, and seconds, or the date. Once set, the calendar will advance, taking into account leap years and differing month lengths. The calendar will also print the date in any order of year/month/day preferred. Other modes imprint any number from 1 through 999,999 for any coding scheme you like, or will sequentially count the frames.

All of that would make that accessory nice in its own right, but there is much more. For one thing, long, unmanned exposure times of up to several hours are possible. Another feature is unmanned interval-photography. That allows the camera to take photographs automatically at pre-determined intervals of between 1 second and 99 hours, 59 minutes, 59 seconds. Once the interval between photographs is determined, the camera is simply set up and left alone. Interval flash-photography is even possible; the multifunction back turns on the flash unit one minute before the interval expires. That feature requires the use of an autowinder or motor drive.

All the special back's functions are accessed and programmed using six keys and a slide switch that are concealed under a cover on the rear of the camera when not needed. The data imprinting is handled by a series of LED's within the back and the interfacing between the back and the electronics of the camera itself is done through three spring-loaded electrical-contact pins.

The last accessory we'll look at is one that is usually associated with cameras costing far more—a wireless-controller set. The set consists of a small transmitter that resembles a spot lightmeter and a receiver that resembles a small flash unit. The

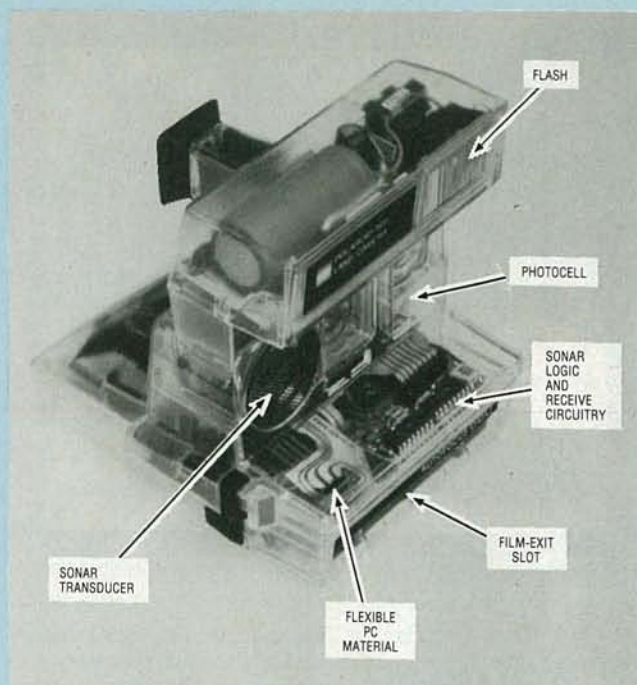

FIG. 4—INSIDE THE POLAROID 660. This autofocus camera uses an active sonar system.

receiver is designed to attach to the camera's accessory shoe, or to a special bracket included in the set.

The wireless control uses near-infrared pulses for communications. That technique avoids problems such as interference and spurious signals so common to radio control. (But the range of the unit can be affected by adverse weather conditions such as direct sunlight or fog and Minolta recommends that operation under actual conditions be checked before any photographs are taken.) Under ideal conditions, communication over distances as great as 200 feet are possible. That communication need not be line-of-sight—the infrared pulses can be bounced around corners or off surfaces. Finally, the unit boasts three independent channels so that up to three cameras, or three groups of any number of cameras, can be controlled independently.

Autofocus

Autoexposure is just one way that electronics has changed the way we take pictures. There are, of course, others. Consider autofocus, for instance. A few years ago, those circuits were bulky, expensive affairs. With the introduction of integrated circuits and large-scale integration, the autofocus circuitry can now be placed on IC's little larger than a postage stamp; what's more important for consumers and manufacturers alike is that the IC's are not costly to manufacture. Autofocus has thus become common on many relatively inexpensive cameras.

Autofocus systems can be grouped into two classifications: active and passive. In an active system, the camera bounces a signal of some type (usually an ultrasonic tone or infrared pulse) off of an object, and uses the reflection to calculate the distance and set the focus. In a passive system no signal is emitted; the camera judges the distance from the subject using optical and electronic means.

Let's first examine active systems. The principles behind a sonar system, such as that used in Polaroid's (549 Technology Square, Cambridge, MA 02139) 660, should be familiar to most. The camera emits an ultrasonic pulse and measures the time it takes for the echo to return.

Let's take a close look at the 660 (see Fig. 4). When the shutter button on the camera is first pressed, a 50-kHz sound burst is generated by a transducer mounted on the front of the camera. When the sonar echo returns to the camera, it is processed by the sonar logic and receive circuitry, shown in Fig. 5,

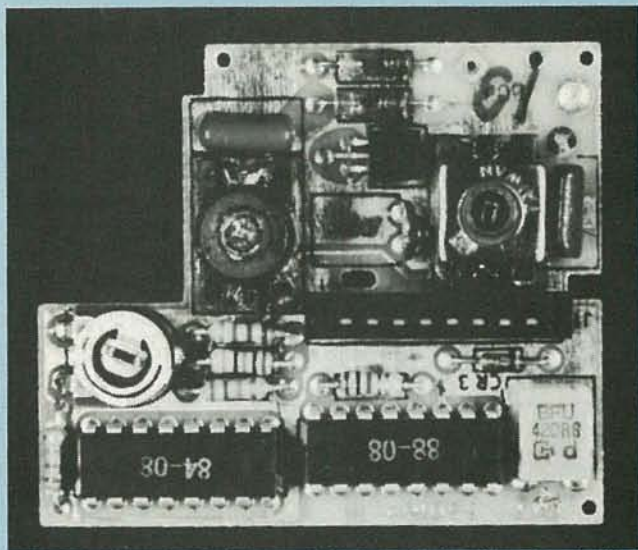

FIG. 5—THIS PC BOARD holds the 600's sonar logic and receive circuitry.

which computes the elapsed time and stores it. From that information, the camera selects the proper supplementary lens (there are four mounted on an internal disc) and rotates it into position, where it is latched and held. With that lens in position, the camera will be properly focused.

At the moment that the disc is latched, a solenoid releases the shutter blade and a silicon photodiode measures the ambient light level. Information from that photodiode is instantly evaluated by the camera's electronics. If the light is greater than 10 candles-per-square foot, the fill-flash mode is selected; at lower light levels, full flash is selected. The flash will fire for all exposures unless manually overridden. As the shutter blades continue to open, the flash fires at the precise moment and at the correct aperture as selected by the camera's exposure-determining logic circuitry. Those factors are determined by the distance between subject and camera. The measured ambient light level is used to determine the duration of the flash, and the distance and the light are used to determine how long the shutter remains open.

The camera's electronics complement consists of the photodiode, an analog circuit that controls the transmission and reception of sonar signals, a voltage-to-frequency converter, a power IC, and the exposure-mechanism logic network.

The camera, including the flash system, is powered by flat batteries developed especially for the 600 series of cameras. Those batteries are part of each film pack.

An active infrared system, such as that used in Kodak's (Rochester, NY 14650) Kodamatic 980L, measures the brightness of a reflected pulse. That system can run into difficulty, however, if the object being photographed is more reflective than average. Fortunately, most objects reflect infrared about the same way, and though the system is not totally foolproof, the slight differences that do occur are unimportant considering the camera's small-aperture lens.

A variation on the infrared technique uses triangulation to determine distance. In that system, the baseline runs between the camera's infrared emitter and detector and the peak of the triangle is at the photographic subject. The distance from the camera to the subject is then found by measuring the base angle of the triangle. That measurement can be done either electronically or mechanically. For instance, a camera might use a set of photodiodes in a rotating mount. That mount is tied to a motor that rotates the diodes until the signals at both are equal. When that happens, it means that both are pointed at the area that reflects the most infrared, which is the object to be photographed. The same motor is also tied to the lens in such a way that it is focused on the area that is indicated by the triangulation. The system described is used by Chinon (43 Fadem Rd., Springfield, NJ 07081) and is shown in Fig. 6.

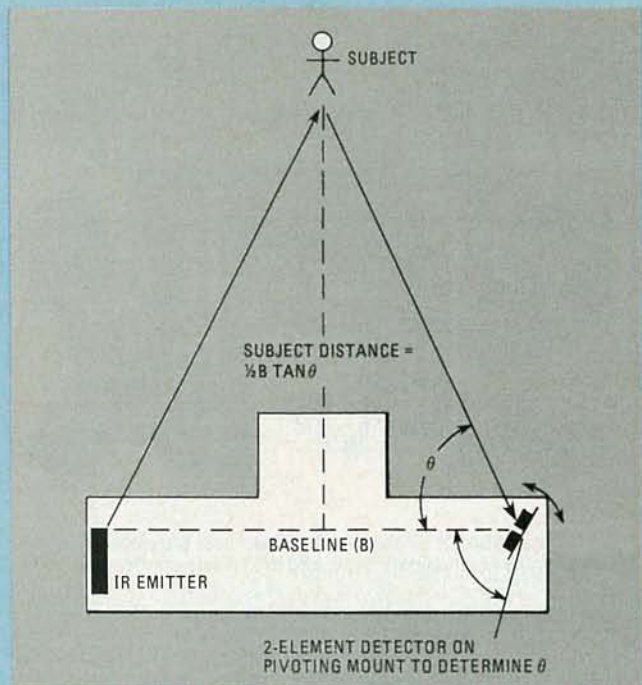

FIG. 6—AN ACTIVE IR autofocus system. This technique, used by Chinon, is based on triangulation.

Turning to passive autofocus systems, most use either triangulation or analyze the image produced by the lens to determine focus.

Passive triangulation systems work much like manual range-finder cameras in that the camera is focused by moving the lens until the two images in the viewfinder correspond. Typical of such systems are Honeywell's (Honeywell Plaza, Minneapolis, MN 55408) *Visitronic* and Canon's (One Canon Plaza, Lake Success, NY 11042) *SST* or *Solid State Triangulation*.

Those systems use arrays of photodiodes to compare the images. Where the systems differ is in how they compare those images. The Honeywell system uses one moving image and one fixed one, much like manual rangefinders. The images are examined by the arrays until they coincide. In the *SST* system, the images are fixed. Two arrays of photodiodes examine the images, and the signals from those devices are analyzed to determine the difference, and hence the distance.

There are two autofocus systems that work by analyzing the image: contrast detectors and focal-plane detectors. Contrast detecting systems, used in cameras such as the Canon *AL-1* and the Pentax (35 Inverness Dr. E., Englewood, CO 80112) *ME-F*, are based on the premise that when the contrast is at a maximum (that is, when the variation in brightness from point-to-point is at a maximum) the image is in focus. Photodetector arrays that are centered around the focal plane, but located at slightly varying distances from the lens, and a microprocessor are used to measure that variation in contrast.

Focal-plane detectors are a bit more complicated, at least in concept. They work on the principle that the light from different points on an out-of-focus subject strikes each point in the film. If those points have contrast (that is if their brightness varies) the aperture will appear to be unevenly illuminated. Conversely, the image will be in focus only if the aperture is evenly illuminated. Thus, to check for focus all that need be done is to use a matched pair of photodetectors to look through opposite halves of the aperture. When both detectors see the same thing, the camera is focused.

From what we've seen so far one thing is clear—that thanks to new advances in microelectronics the nature of photography has changed dramatically. Although it may appear that you're only pushing a button, what's going on inside the camera is making it possible to take pictures under all kinds of conditions with amazing results.

R-E

SPECIAL SECTION

IF YOU'VE BEEN AN AMATEUR PHOTOGRAPHER for more than just a few years, you probably remember when the state of the art in photo accessories was a strobe unit that was about the size of a hammer and weighed just about as much. They were the ones that also required an outboard 9- or 12-volt battery pack to drive the flash tube. And after a couple of hours of use they felt as if they weighed several hundred pounds.

Obviously, the scene has changed radically today—many cameras, even inexpensive ones, have built-in strobe units that are powered by a couple of penlight batteries. But the serious amateur photographer has available to him “smart” strobes that can communicate with “intelligent” cameras to produce high-quality photos. These smart strobes boast the same light output as their ancient relatives, but they do more, and are much smaller. In fact, some are so small they can literally fit in your shirt pocket with room to spare.

And strobes aren't the only photo accessories that have seen some radical changes during the last 20 years. Remember the old light meters? They were handheld affairs that offered good accuracy, but using one required spinning dials and matching needles.

Today's advanced light meters, while still about the same size as their counterparts from the 1960's, have lost all of their dials and needles. Now built-in microcomputers and LCD readouts make finding the right exposure setting easier than ever.

Photo Accessories

Camera accessories have not been left out of the “electronic revolution.” Microprocessors, memories, and LCD's are among the features that you'll see.

MARC STERN

Strobe units

Before we look at individual strobe models, let's take a look at what a strobe does, how it works, and some features it might contain.

Some strobe units cannot be adjusted—they flash for a given length of time. They usually contain a “computer” dial. To use them, you first dial in the film's ASA number. Then you can dial in the distance from the subject and read off the *f*-stop you need to use a particular aperture you can dial the *f*-stop up on the calculator dial, and it will tell you the distance that you should be from the subject. When the strobe is used, the camera is set to its *x* position; that sets the shutter speed (usually to about a sixtieth of a second) and causes the camera to close a switch that sets off the flash when the shutter opens.

Dedicated strobes

There is another type of flash unit called the *dedicated strobe*. When the word “dedicated” is applied to strobe units, it means that that unit is tied to being used with one particular camera—or at least one made by a particular manufacturer. If you want a smart unit—a strobe that communicates with the camera to set

the shutter speed, select a suitable aperture, activate viewfinder information (such as a flash-charge indicator), and control flash duration—then what you need is a dedicated strobe unit.

What makes one strobe setting different from another is not how *bright* the unit fires. Rather, it is the length of time that it fires. With the non-automatic strobe that time is constant, and to obtain the correct exposure you have control only over the *f*-stop setting and the distance from the subject.

Automatic strobes, on the other hand, use a photo cell to “look” at the amount of light that is reflected by the subject. When it determines that it has received enough light for the proper exposure, it then shuts off. An example of a dedicated electronic flash is the *Speedlight 166A*, from Cannon (One Canon Plaza, Lake Success, NY 11042) shown in Fig. 1. It mounts in the accessory shoe of Canon's *AL-1*. When the flash is fully charged, it automatically sets the camera's shutter speed to $\frac{1}{60}$ second, and a light on the flash tells you that it's ready. The flash gives you a choice of two apertures; it displays them in a window on the back of the flash. The settings depend on the speed of the film that you're using. The distance ranges that are available with the selected *f*-stop are shown on a table on the

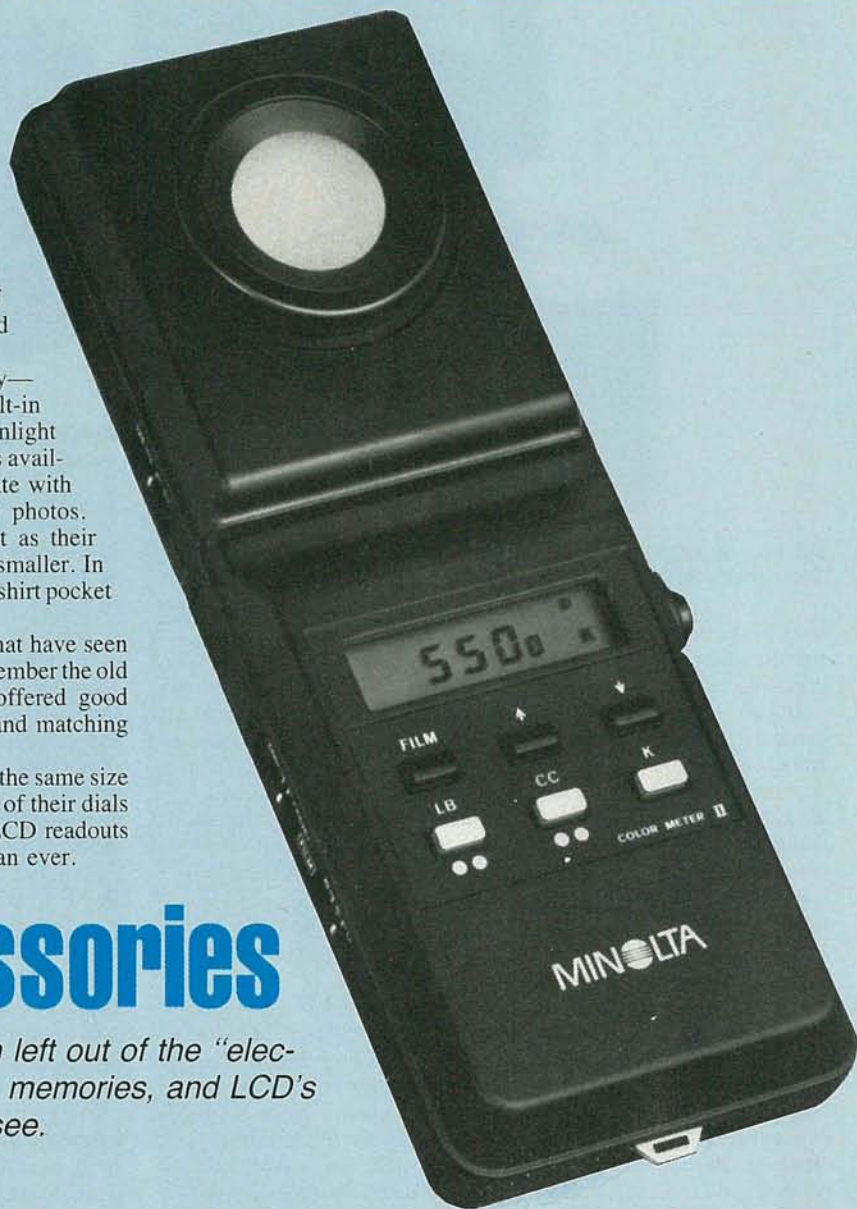

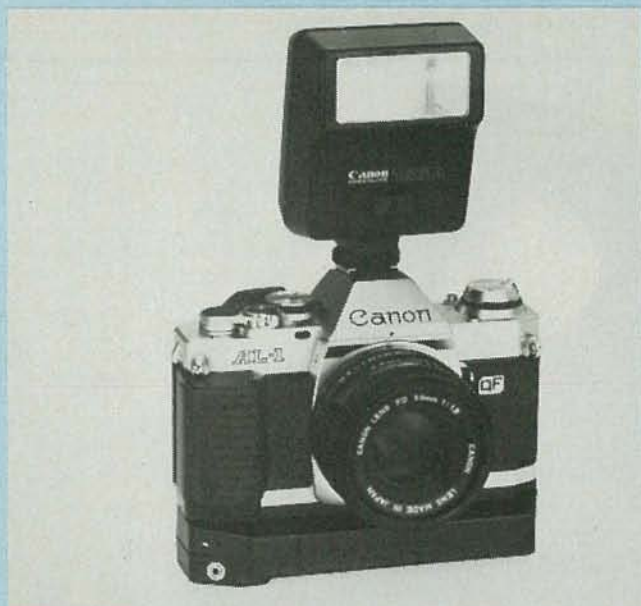

FIG. 1—A DEDICATED ELECTRONIC FLASH. The Speedlight 166A from Canon fires from 1/50,000 to 1/1000 second.

back of the flash unit. When you take the picture, the strobe fires for anywhere from 1/50,000 to 1/1000 second—automatically controlled.

If you want a smart—therefore, dedicated—strobe for your camera, you don't have to be limited to buying one from your camera's manufacturer. Thanks to the flexibility afforded by microelectronics, it is now possible for one manufacturer to build a strobe unit that can be dedicated to a number of different cameras. An example of that is Vivitar's 3000 series of dedicated flash systems. It is designed to work with cameras from the Canon, Minolta, Olympus, Nikon, Pentax, Yashica, and Contax lines, as well as just about any of the other popular single-lens reflex (SLR) cameras on the market—provided that you buy the correct Vivitar dedicated module.

Like many other strobes now on the market, the Vivitar (1630 Stewart St., PO Box 2100, Santa Monica, CA 90406) 3500 uses energy-saving circuitry to keep the flash recycling-time down. On units without that circuitry, when the flash has fired long enough for correct exposure, the rest of the charge on the flash capacitor is "dumped." With the energy-saving circuitry, however, the unused charge can be recycled, thus saving the batteries and reducing the flash charging-time. That means that the flash can sometimes be used with an autowind camera, depending on the distance to the subject. (The farther the distance, the longer the flash has to fire, and thus the longer the recycling time.)

Vivitar's 5600, though, is a better example of an electronically advanced strobe unit. It is shown in Fig. 2. Like the 3000 series, dedicated processor modules are available that let you interface the 5600 to a wide range of popular cameras. Another module is available with a PC cord that allows you to adapt the flash unit to non-dedicated cameras. The feature of this strobe that sets it apart from others is its LCD readout. That readout eliminates confusing calculator dials and mathematical computations—all the information you need to know is displayed in easy-to-read form. Let's take a look at how you would use that strobe, first in its automatic mode. As we discuss the LCD readout, refer to Fig. 3

When you first put the flash unit in its automatic mode, an AUTO indicator is displayed and the unit beeps three times. (That, and all of the unit's audible indicators, can be switched off if silence is necessary.) Then you tell the 5600 the speed of your film (using either ASA or DIN standards). Next you tell the unit the *f*-stop (eight choices from *f*/1.4 to *f*/16) you want to use. The flash range then appears on the display (in either meters or feet) on a bar graph. Also, the maximum distance is displayed



FIG. 2—THE LCD DISPLAY of the 5600 modular flash system from Vivitar makes this unit very easy to use.

numerically. If you change the *f*-stop, the display recalculates the range. The flash duration range is from 1/30,000 to 1/1000 second.

The flash operates a little differently in its manual mode—the most significant difference being that the flash duration is always 1/1000 second (it does not adjust automatically). When switched into the manual mode, the unit signals with three double-beeps. When you program in the *f*-stop, the display shows the distance for the correct exposure. In the manual mode you have a choice of 12 different *f*-stops (as compared to eight in the auto mode). As you change the *f*-stop, the readout changes the display to show the optimum distance to the subject. (In the manual mode the distance to the subject is more critical than in the automatic mode because of the fixed light-output.)

At the heart of the 5600 is a custom microprocessor that drives the LCD display and accepts inputs from the strobe's photosensor unit. This unit not only accepts user inputs, but also compares those inputs against preprogrammed, proprietary logic and derives the display figures. This unit also controls the flash output in the auto mode and contains all the system driver-circuits.

In the AUTO mode, you can check whether or not the exposure selected will work by firing the flash manually (without snapping a picture). If an acceptable picture will result, the AUTO symbol flashes. (An audible signal can also be enabled.) The AUTO symbol will also flash after you take a picture if the amount of light was sufficient for proper exposure.

The LCD also indicates the angle of coverage for the flash head being used. (There is a variety of heads available for the 5600, including a zoom head.)

Special voltage-sampling/timing circuitry also enables the microprocessor to flag weak batteries. If the batteries fail to recycle the unit within 35 seconds, the battery-replacement symbol is activated. (The normal recycle time is less than 12 seconds if alkaline batteries are used, and less than 7 seconds if the optional nickel-cadmium battery pack is used. A "starburst" is seen in the display when the flash is fully charged.) The warning symbol indicates that the batteries can still be used, but that they are in a weakened condition and should be replaced soon.

Like the other strobes in this line, it is possible to use this one with any of the popular single-lens reflex cameras by employing special processor modules. These modules contain the necessary electronics for interfacing the strobe head with the electronics inside the new generation of "intelligent" cameras.

Vivitar isn't alone in offering this type of flash, either. The major camera manufacturers, among them Pentax, Minolta, and Canon, also offer dedicated units that interface with, and take advantage of, the electronic circuitry in their equipment.



FIG. 3—A CLOSE UP VIEW of the 5600's LCD display shows just how much exposure information it can provide.

Light meters

Most photographers rely only on their camera's built-in light meter for their exposure measurements. And with the quality of those built-in meters, you might be wondering why anyone would want to use anything else. Serious photographers, however, often *do* want to use an accessory meter. That's because there are many instances when the readings from the built-in meter are too general. And that's why the hand-held light meter is still around. It can help eliminate a lot of the extra exposures and guesswork that often go along with getting just the right shot. But today's light meters are not what they were even a few short years ago.

Before we start discussing how they have changed, let's clarify what we mean by saying that there are situations when should use an accessory light meter. Assume that your subject is standing in the shadows with strong backlighting. Your built in light meter would provide you with an exposure setting based on the overall lighting that it sees, and the resulting picture would be underexposed—the portion you were interested in would be not much more than a silhouette. However, with a hand-held light meter, you could determine the proper exposure setting by measuring the amount of light reflected by or falling on just the subject, and not have to rely on a possibly erroneous overall reading.

This discussion of light meters will not try to be a roundup of manufacturers' products; we just want to give you an idea of what features are available due to advances in electronics. Therefore, we will use one manufacturer's (Minolta's) line as an example.

The first meter we will look at is Minolta's (101 Williams Drive, Ramsey, NJ 07446) *Auto Meter III*, shown in Fig. 4. We find it is built around a custom-built microprocessor, the "brain" of the unit. Its LCD readout makes it easy to use—No longer does a photographer have to twirl dials and match numbers to find correct exposure settings.

A memory in the *Auto Meter III* allows you to store one or two measurements, which can be recalled and compared to the third one being taken. To make the comparison easier, the *f*-stops of all three measurements are displayed on what Minolta calls a "dot-array display." They can be recalled one at a time as desired.

Let's look at how you would use the meter. The first thing that you have to do is to set the film speed and the shutter speed desired. Then, simply pressing the measurement button causes the meter to compute the *f*-stop or EV number (you choose which one you want) that is required for proper exposure. The number is displayed both digitally and by a dot on the dot-array display.

By depressing the memory key, you can then enter that value into the unit's memory. You can then take a second meter reading (at a different shutter speed) and enter that one in memory.

If you need a third measurement, you can take one and it will be instantly displayed. Then, with the RECALL key, you can recall the two previous readings. The *f*-stop (or EV) settings for

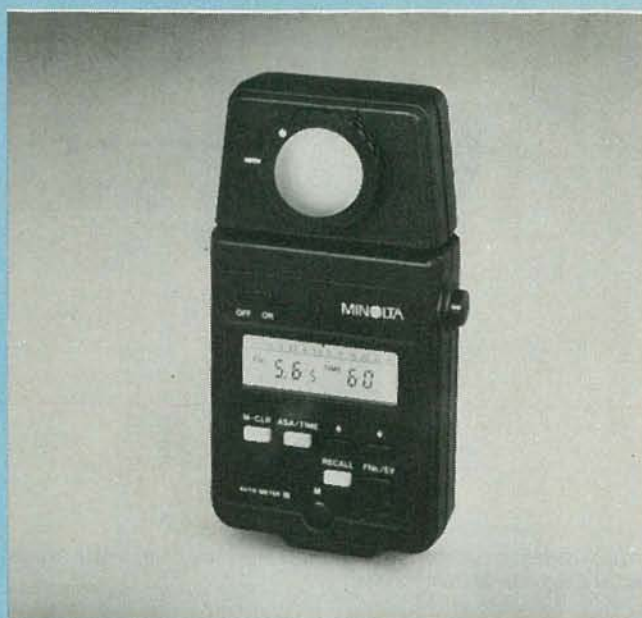

FIG. 4—ALTHOUGH COMPLEX INTERNALLY, the *Auto Meter III* from Minolta is a snap to use.

all three readings are always displayed on the dot array.

That the microprocessor provides versatility is apparent from the fact the photographer can change the film speed set, or the shutter speed, even after the measurements have been taken. When they are changed, the microprocessor automatically adjusts for the changes and indicates the new data in the display.

One of the beauties of an all-electronic meter is its reliability. Since there are few moving parts, mechanical failure or wear is nearly nonexistent.

Spotmeters

A spotmeter, which is a special type of reflected-light meter, is a meter for the more advanced photographer. When such a meter is aimed at the subject it allows him to measure the amount of light from a very small area, so that he can determine the proper exposure setting with great precision. Minolta's *Spotmeter M*, shown in Fig. 5, has a one-degree viewing angle.

That meter uses the same type of microprocessor control and LCD readout as the one we previously discussed, but, being a spotmeter, it allows the photographer to measure the lighting on the exact spot he wants to measure—a highlight or shadow, for example.

Three buttons, labeled *s*, *h*, and *a* (shadow, highlight, and average), are included. When the "shadow" button is pressed the microcomputer recomputes the exposure settings so that the measured spot will be exposed as a shadow. The "highlight" button is pressed for the exposure settings so that the measured spot will be exposed as a highlight, while the "average" key will give the average of the other two readings. That feature is especially useful when taking portrait shots—it allows you to be more creative because it lets you get precisely the effect that you want without a lot of guesswork.

Another type of electronic spotmeter is represented by Minolta's *Auto-Spot II* and *Auto-Spot II Digital*. Like the *Spotmeter M*, they are hand-held spot meters. The interesting feature of the *Auto-Spot II*-line is a "total-information" viewfinder that indicates all necessary information at a glance for proper exposure. With this meter, the scales in the finder move continuously until the trigger is released—then the readings are locked. The key difference between the two meters is that the *Digital* presents a digital readout, while the *Auto-Spot II* presents an analog one (on rotating scales).

Today's light meters are very different from light meters of the past. Their main advantage is that they can be used more accurately. That's not to say that the meters used years ago were



FIG. 5—THE SPOTMETER is a special type of reflected-light meter. Shown is the *Spotmeter M* from Minolta.

not accurate—in many cases they were. But because they were more difficult to use, and because they could be misused easily, the chance of error—usually the fault of the photographer—was high.

With older meters, the light falling on a photocell generates a voltage that then moves a meter needle which is read by the photographer and, based on that reading, dials are turned so that the correct exposure settings can be determined. Today's meters read the light level, take into consideration the user's inputs (such as film speed and shutter speed), and then tell him the correct exposure settings and camera-to-subject distance in an easy-to-read form.

In the 1960's, selenium cells were used primarily, but they

were not as accurate as other types of devices and they suffered from several shortcomings. They were replaced in the early 1970's by CdS (cadmium sulfide) photoconductive cells. Those allowed for more precise measurements, but they also had their drawbacks. One of the more troublesome problems was that they could develop "memories." That effect, called the light-history effect, means that the conductance of the photocell is a function of not only the light that it "sees" now, but it is also a function of the cell's previous exposure to light.

The photography industry found the answer to that problem in silicon cells, which can be used as accurately as the cadmium-sulfide cells, but don't suffer from the same problems.

Two other byproducts of electronic technology are flash meters, such as Minolta's *Flash Meter III*, and color meters. Essentially different types of light meters, they, too, use large-scale-integration and LCD technology to assist the photographer. For instance, the flash meter provides precise incident or reflected-light readings of electronic or bulb flash, or continuous illumination, or combinations of them. At the push of a button, a microprocessor turns the results of those readings into a display indicating the correct *f*-stop for a given situation so that the camera can be set correctly. The color meter allows a photographer to determine what filters, if any, are needed to ensure accurate color reproduction.

A relatively new camera accessory that is becoming increasingly popular is the electronic camera-back. Some such backs can imprint the date or time of exposure; the film type and exposure settings, and some can even operate the camera automatically for time-lapse or long-exposure photos. We won't go into more detail at this time; a multifunction back was discussed in a previous article in this section.

As you can see, photographic accessories have come a long way in the last two decades, thanks to the microelectronics revolution. They have given every photographer the chance to produce high-quality photos, something that everyone strives for. R-E

THE ALL-ELECTRONIC MAVICA

continued from page 62

affects of jitter on transmission, it is effectively cancelled by extracting the jitter signal from the video and using it to modulate the 14-MHz sampling clock. Since both signals then contain identical amounts of the same jitter component, it is nullified, and the sampled signal is free of that annoyance. The jitter-free digitized video is then stored in the memory of the transmitting unit.

The 800-Hz signal derived from the digital-to-analog conversion process is fed to a lowpass filter to eliminate spurious signals, and its level adjusted to meet the requirements of phone-line transmission.

At the receiving end of the system, further steps are taken to ensure the highest possible image quality. Because phone line signal-levels fluctuate greatly, an automatic-gain-control circuit using a reference signal contained in the system-control signals that start each image transmission is used to adjust the received signal to the proper level. The Sony engineers also realize that the phone system has a rather poor signal-to-noise ratio, and have adjusted the image signal to take that into account. In their system, the extremes of the image signal are the levels representing black and white. The horizontal-sync signal, which is normally "blacker-than-black," is inverted and extended to equal the peak white-level. Because the circuitry may have problems differentiating between a signal that represents pure white and one that represents horizontal sync, a vertical sync signal (also at the 100% level) is transmitted during the interval that contains no image. It, and the fact that the horizontal-sync pulses occur at regular intervals, prevent the sync and image signals from becoming confused. Figure 8 shows a comparison of a standard

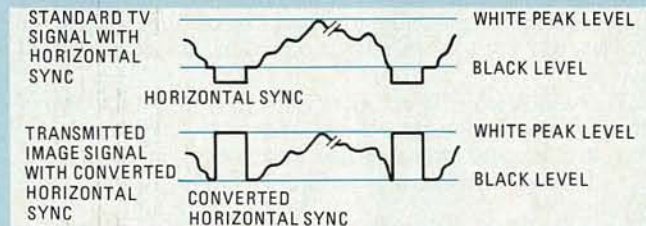

FIG. 8—STANDARD VIDEO SIGNAL (a) compared to signal used over telephone lines (b). Note how sync is inverted and maintained at white-level (as opposed to blacker-than-black) in the latter.

TV signal (a) and the one transmitted over the phone line by the Sony system (b).

The received signal is stored in memory and undergoes digital-to-analog conversion (essentially the reverse of what was done at the transmitting end). The image can then be viewed on a TV screen, or printed by the Mavigraph. (You can also record the digital signals on a standard audio cassette, and play them back when you desire.) It takes about four minutes to transmit one picture by this method.

Although this is a somewhat simplified explanation of what goes on, it describes what is perhaps the most important use of filmless electronic photography and demonstrates the ability to combine video with many different forms of media.

Since the Mavica system is based on electronic video signals, it is also compatible with other electronics equipment. It will be possible, then, in the long run, to use and integrate photos and other pictorial matter with computer-generated reports or to access and use pictorial matter in other electronic ways.

The Mavica system has a great deal of potential in many realms, and though we may have to wait a while before we can use it at birthday parties, we are certain to see it widely used commercially. R-E



Electronics in The Darkroom

Precise timing and repeatability of results are essential in the darkroom—especially for color processing. The use of electronics in what were previously all-mechanical devices allows a new degree of accuracy to be attained.

MARC STERN

NOT TOO LONG AGO MAKING COLOR PRINTS WAS SO DIFFICULT—especially for the amateur—that many who were proficient in black-and-white darkroom techniques absolutely refused to get involved with color. Processing times and temperatures were critical, filtration and exposures were hard to determine, and the chemicals were a nightmare! It could take an entire evening to make just one satisfactory print. The chemistry end of color processing was simplified about ten years ago, but it wasn't until recently that electronics made color printing really easy. We're going to discuss some of the ways it has done so.

Temperature control

One of the most critical factors in color processing is the temperature of the chemicals used. Color work is much more temperature critical than black-and-white—some of Kodak's processes require the chemicals to be within $\pm 1/4$ -degree of a certain temperature (usually around 100° F.)

To measure temperatures accurately, an electronic digital thermometer like the Omega CF-20 can be used. Employing large-scale circuit integration and a solid-state sensor, the thermometer displays almost laboratory-precise readings on a 3½-digit LED readout. The thermometer, which is calibrated to

National Bureau of Standards guidelines, has a range of 59° F. to 140° F., and is accurate to $\pm .25$ -degree F. Its probe is made of chemical- and heat-resistant plastic, and is designed to hang on tanks and trays without slipping or rolling. The thermometer can be powered by four 1.5-volt "AA" cells or a rechargeable nickel-cadmium battery pack.

Color analyzers

One of the trickiest parts of color printing is color balancing—it's like adjusting the hue control on an old color-TV set for correct flesh-tones, only harder. A number of variables are involved, including the lighting conditions under which a picture was taken and—more critical—the particular emulsion batches used for the film and printing paper. (Each batch of paper or film produced by a manufacturer varies slightly from the ideal specifications for color properties. These have to be compensated for in the printing process through the use of filters.)

Color balancing is simplified by a device called a color analyzer, which measures the color content of the light projected through the negative or slide and, "knowing" the filtration requirements of the particular paper and film being used, de-



FIG. 1—OMEGA'S SCA 300 DIGITAL COLOR ANALYZER can accept user-programmable RAM modules that greatly reduce setup time.

termines the filter values that must be used. It should be mentioned that some filtration is *always* required; the exact amount depends on a number of factors. Because of their cost, color analyzers used to be considered luxury items, but today they almost have become necessities as the costs of paper, chemicals, and other photographic materials have climbed through the roof. Any waste of those items is needless and it is also rather expensive.

A good example of the state of the art in color analyzers is provided by Omega's (Omega Division, Berkey Marketing Companies, 25-20 Brooklyn-Queens Expressway West, Woodside, NY 11377) microprocessor-controlled SCA 300. The SCA 300, shown in Fig. 1, can accept computer-type RAM (Random Access Memory) programmable memory-modules; each module is programmed by the photographer for a specific film/paper combination. With one of the modules installed, the analyzer allows him to make any number of prints without missing a beat—without his having to retest, reset, or reprogram anything. When a photographer uses a particular combination again, all he has to do is insert the correct module.

The probe contains a set of three silicon cells with matched dichroic and narrow-bandpass filters. In use, it is placed on the printing easel, in place of the paper, and the cyan, magenta, yellow and exposure readings taken in sequence. Each reading is displayed on a 3½-digit variable-intensity LED readout. When all the filter values and the exposure time have been determined and set, the probe is removed, the paper put in place, and the exposure made.

The analyzer, which includes a feature that allows adjustment of the overall color-sensitivity level without affecting stored programs, is capable of selectively displaying the amounts of cyan, magenta, and yellow filtration needed, and the proper exposure time, with the push of a button. It also allows a photographer to recall any previously stored information from memory. The unit has built-in voltage and temperature stabilization and can operate from 117 or 230 VAC, 50/60 Hz.

A device that can be used if you need only to determine exposure times is the *Volomat* light integrator from Karl Heitz (937 Third Avenue, New York, NY 10022), which is a densitometer for black-and-white prints, or for color prints from slides.

The sensor is a cadmium-sulfide cell, whose output, after processing, lights one of a series of LED's. The readings are accurate to one-third of an *f*-stop. The 12 LED's correspond to light values from 0 to 2 lux, and the exposure times that can be read range from 0.7-second to 430 seconds.

Battery powered, the densitometer features a green-LED test light that also indicates when there is too much light on the easel. A chart on the instrument can be used to determine exposure times for seven different paper grades. In normal use, a light



FIG. 2—THE GRALAB 20 DIGITAL DARKROOM TIMER can sound a short tone each second to permit the darkroom worker to carry out time-critical operations like dodging and burning-in without having to watch the time display.

diffuser is placed in front of the lens of the enlarger, but the device can also be used to take spot readings to determine contrast, or from specific parts of a negative.

Timers and color analyzers

With the correct exposure information and timing information in hand thanks to devices like the ones just described, the photographer then can program an all-electronic darkroom timer to turn on the enlarger for the correct length of time. Those devices can either be simple stand-alones, like the Gralab (Dimco-Gray Company, 8200 S. Suburban Rd., Centerville, OH 45459) model 500 or 520 (the latter is shown in Fig. 2), or they can have additional features. We'll see an example of that shortly.

The Gralab 500/520 timers use a quartz crystal timebase to eliminate interference from power lines, and to ensure accuracy regardless of line-frequency variations. They can be pushbutton-programmed for times from 0.1-second to 99 minutes, 59.9 seconds.

The timers provide readouts on four-digit red-LED displays. The intensities of the displays can be set bright for high lighting-levels or low for good readability in total darkness. The timers have grounded outputs for enlarger and safelight control; the enlarger and printer can be switched on or off either manually or by the timer. Both units can repeat the selected time as often as desired, ensuring fast production and identical exposures for large print-runs. They can also generate a metronome signal at one-second intervals (useful if you have to time a process but can't watch the display), and a two-second signal indicating that the timer has reached the end of its count. The model 520 allows the photographer to program two different time settings, each of which can be instantly recalled. The two settings will remain in the unit's memory until cancelled.

The more sophisticated microprocessor-controlled Omega CT-40 timer/controller (see Fig. 3) allows up to 17 sequential time-intervals to be stored in memory. It can be programmed to stop after each step, or to pause for 10 seconds after each interval and then continue automatically to the next; there is even an independent time-of-day clock. Seven different audible signals can be selected for use with each step. The device is extremely valuable for timing multi-step processes such as making color prints or developing color film, which involve several chemical baths and water rinses.

The CT-40 uses a membrane keyboard, something of a necessity in the harsh chemical atmosphere of a darkroom where strong processing agents can easily ruin a device. The keyboard has luminous markings, which makes it easy to use under darkroom conditions. A tone is heard each time the microprocessor registers an input.

The 4-digit red-LED display indicates the elapsed time and, when the unit is in the PROGRAM mode, the current sequence-step. That provides visual confirmation of the audible sequence selected.

The clock has an accuracy of ± 0.5 percent, and timing



FIG. 3—THE OMEGA CT-40 DIGITAL TIMER/CONTROLLER allows the user to program up to 17 consecutive time intervals. This feature is extremely useful for complex multi-step color-processing procedures.

functions can be entered in either "minutes:seconds" or "seconds:tenths-of-seconds" form. There are two timing ranges: the first covers a range of 0.1-second to 9 minutes, 99.9 seconds in 0.1-second steps; the other goes from 1 second to 99 minutes, 99 seconds in 1-second steps. The timer can be stopped and restarted at any time without affecting the timing sequence.

An optional expansion-interface allows the use of pre-programmed plug-in process-control cartridges for automatic operation. Those cartridges automatically program the timer for all popular photographic processes, including Cibachrome, Ektaflex, R-14, and others. A single cartridge can contain information for about 60 steps.

The expansion interface also permits the use of additional darkroom accessories: an exposure probe for automatically setting the correct exposure time, a temperature probe (with read-outs in both Fahrenheit and Centigrade), a digital PH-indicator probe, and others. It also has a built-in self-test program for the CT-40 that checks all 17 program steps, all the digits and indicators, and runs through a 10-second timing check—all in just 20 seconds.

An even more sophisticated device is the Omega SCA 400 automatic digital color analyzer/timer, which combines both color analyzer and timer functions in one microprocessor-controlled unit.

Featuring eight programmable memories, and four-channel simultaneous digital readout of color filtration and exposure time, the analyzer can compute the weighted sum of the yellow, magenta and cyan filter values and automatically set the exposure time. (Of course, if you want, the time can also be set manually.)

The eight memories allow eight different settings for specific paper/film combinations to be stored in nonvolatile RAM; the settings are retained when the unit is turned off. Only two keystrokes are required to access and program the memories. If more—or less—light is required from the enlarger, the unit automatically displays the words "LO" or "HI."

A line of similarly sophisticated solid-state timers and analyzers is also available from Beseler Photo Marketing Co., Inc. (8 Fernwood Rd., Florham Park, NJ 07932).

Enlargers

Enlargers have gotten very smart, too. One example of how smart is provided by Omega's D5500 enlarger system, shown in Fig. 4.

The system starts with an automatic dichroic lamphouse. Repeatability is extremely important in color printing—when you dial in a certain combination of filter values, the color output



FIG. 4—THE D5500 COLOR ENLARGER SYSTEM is unique in that the color head has no user-operable controls—all adjustments are made either automatically or from a console keyboard.

of the color head (the lamphouse together with its dichroic filters) should always be the same. Over time, though, what you want may not be what you get, due to lamp aging, the darkening of reflecting surfaces, and other factors. A specially designed quartz-halogen lamp from General Electric helps reduce that problem; the D5500 lamphouse corrects for it by constantly monitoring its own color output using a set of three silicon-cell color sensors.

The outputs of those cells are fed to a microprocessor-controlled circuit that "knows" what the normal color-output should be and automatically corrects the filtration as needed. The three dichroic filters, whose positions in the light path determine the color output of the head, are moved to the correct positions by separate DC motors in response to the output of the color-control circuit. Those motors are also used to introduce the amount of filtration selected by the photographer for printing; unlike other color heads, that of the D5500 has no external color-control knobs—everything is controlled electrically or electronically.

The heart of the D5500 system is its auto CLS (Closed Loop System) controller, which can also be seen in Fig. 4. It connects to the lamphouse, and allows all timing and filter settings to be made from one console.

The controller has a backlit membrane keyboard that is used to enter filter and exposure data for the enlarger's color head. Four 3-digit LED displays show the filter values and time selected; the intensity of both the displays and the keyboard lighting is adjustable.

Filtration values can be entered from a numeric pad, or

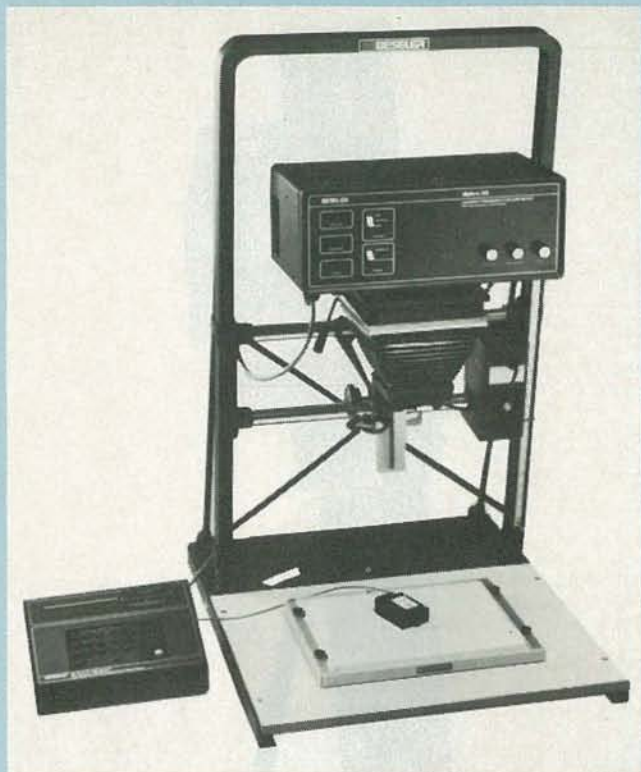

FIG. 5—BESELER'S *DICHO 45* enlarging system is programmable by means of plastic cards with magnetic stripes.

increased or decreased step-by-step by "up/down" keys. Exposure times can be entered in two ranges: from 0.1 second to 99.9 seconds (in 0.1-second increments) or from 100 seconds to 999 seconds (in 1-second increments). Whenever the controller requires information to be input, the appropriate key is illuminated to call the operator's attention to it. This feature is especially useful when several steps have to be entered in a particular sequence—the keys will light up one after the other. That makes it difficult to make a mistake.

Two controller models are available. The first is the *Auto CLS Controller* just described. The second, the *Auto CLS Translator/Controller*, offers several additional features.

In addition to doing everything its smaller cousin can, the translator/controller can be connected to a video color-negative analyzer like those used in high-volume operations, and the color-correction factors determined using that device will be fed directly to the color head of the enlarger. The translator/controller also comes with a density probe for making on-easel exposure measurements.

If desired, the unit can be connected to a color analyzer (like the CA 400 described earlier), and the output of the analyzer converted directly into signals to control the color head. In addition, it has a 25-pin "computer-type" connector, which, Omega says, allows for future interfacing with external memory storage-devices, magnetic-card or paper-tape readers, and various on- and off-easel densitometric devices.

The translator/controller has 19 program memories and includes a number of automatic diagnostic features. Among them are a line-frequency check, a temperature check (for the lamp-house), and a "high-low" light-intensity check (when the density probe is used).

A recently introduced option for the system is a parallel computer-interface, which answers the need for computer control of laboratory processes. The reason Omega chose a parallel interface is because its research showed that most of the computers with which its system would be interconnected used a parallel printer port. The company has solved interface problems associated with interconnecting parallel ports by using a BASIC program and supplying listings that show how to customize the

program for particular computers. Among the computers supported are the Apple computers, the *TRS-80*, the *IBM PC*, and others that use Microsoft BASIC.

Another computer-controlled enlarging system is the Fujimoto *G70*. Although not as automated as the Omega system, its color analyzer—which is built into its base—allows precise determination of filter requirements and repeatability of results. It is marketed by Colourtronic (9650 Topanga Canyon Place, Chatsworth, CA 91311).

The Beseler *Dichro 45* system, shown in Fig. 5, uses a microcomputer-controlled dichroic-head color system similar in some respects to Omega's. It, too, checks the quality of the light it outputs. Instead of automatically changing the position of the filters, however, it changes the figures displayed by the 7-segment LED's that indicate the color makeup of the light inside the head's mixing chamber. A switch allows you to see the actual value of the filter pack, or its effective value. The color head contains a 3870 microprocessor, custom-programmed by the company, that serves as the basic function-controller for the electronics package.

Though only about one-quarter-inch square, the microprocessor chip can collect data, make decisions and calculations, and provide output, commands and control signals. Other electronic components in the color head include a quartz-crystal oscillator and nine integrated circuits (including three MOSFET op-amps and three opto-isolators).

When the photographer turns on the system, three solid-state photodetectors read the actual color of the light within the mixing chamber of the color head. The particular devices used were chosen because they are extremely sensitive and don't have the infrared-response problems associated with silicon photodiodes. They also closely match the spectral sensitivity of color photographic-materials.

The signals from the detectors are fed into three MOSFET operational amplifiers, and from there to a multi-channel analog-to-digital converter. The microcomputer reads and stores the data, processes it, and outputs two simultaneous signals. The first is a BCD (*Binary-Coded Decimal*) signal that is sent to a BCD-to-decimal decoder which then provides a signal to select the proper LED display. The second signal supplies the display selected with the appropriate information. The information is updated every tenth of a second, so that any variation in the color of the light is immediately detected and can be corrected for.

The microprocessor also performs a number of other functions, including a self-test diagnostic routine.

Signals to and from the color head can be controlled by what Beseler calls its Data Access Timer Analyzer module, or D.A.T.A. The module is connected to the head by a 24-pin connector.

While the D.A.T.A. module allows you to program the color head manually, it also has a built-in magnetic-card reader that enables it to read data from or write it to a specially designed D.A.T.A. card (which looks much like an ordinary credit card).

The module can store and make use of many types of data, including analyzer programs; color-head-memory offsets; specific information about a particular negative or slide; and information for automatic variable-contrast control and paper/film-emulsion and density control.

With a probe containing three photodetectors, the module can act as a color analyzer. A timer function lets it address the quartz-crystal oscillator built into the color head, providing an enlarging timing capability and exposure repeatability controlled by the on-board microcomputer.

It can also perform as a multiple-memory digital color analyzer with a one-button push-to-program feature. Any number of color-analyzer programs can quickly be stored on D.A.T.A. cards for later use.

As you can see, the nature of the darkroom has changed, thanks to microelectronics. And, since we have progressed this far, can the totally automated, computer-controlled darkroom be far away? Only time will tell.

R-E

BUILD THIS

EXPAND

Your TIMEX/SINCLAIR Operating System

We told you that you could store system-software modifications in this RAM expansion. When we finish up the construction we'll look at just a few of the possibilities.

Part 2 WHEN WE FINISHED UP last month, we had almost completed the construction of the CMOS RAM board. We still have a lot to cover, so let's get started right away.

Look the board over carefully for any loose bits of solder, solder bridges, cold-solder joints, and incorrectly placed components. Connect five volts across the \pm VOLTS and GROUND pins on the edge connector (the computer itself is a good source for the five volts) and test for correct voltages at the appropriate socket pins. The CMOS memory IC's are expensive, and it's a good idea to spend a few extra minutes checking the board at this stage before you insert them.

If you're satisfied that all is correct, then you can plug in the integrated circuits. Be careful when you handle the CMOS IC's, though—ground yourself before touching them, and don't touch the pins unnecessarily. You will probably

find that the pins are spaced too widely for the sockets. If that is the case, bend the pins slightly inward by pressing one side of the IC at a time against a hard grounded surface. A piece of aluminum foil on a flat surface works fine.

Options

The 8K RAM board offers several options, most of which are selected by positioning jumpers as we will describe in this section.

We'll start our discussion with jumper JU1—the jumper that is used to select the particular 8K block of addresses where the board will reside. On the board, the JU1 area contains five pads, one of which is the "common." A wire should be inserted between the common and one of the other four pads, as shown in Fig. 9.

The memory board can accommodate four 2K 6116P CMOS RAM's, four 2K 2716 EPROM's, or two 4K 2732



PAUL W.W. HUNTER

EPROM's (in the IC1 and IC2 sockets). As shown in Fig. 10, the signals at pin 21 are different for the three memory devices. Therefore, jumper JU2, as shown in Fig. 11, is used to "program" the board for the type of memory IC used. The Z80 \overline{WR} control signal is jumper-connected to pin 21 when 6116P CMOS RAM's are used. But for the 2732 EPROM's, pin 21 is connected to All; and for the 2716 EPROM's, pin 21 is held at five volts.

To control output of the \overline{RAMCS} and \overline{ROMCS} signals from the memory board, "jumpers" (some of which are actually 1N4148 diodes) are used.

Jumper JU3 gives the user the option of disabling the ZX81's internal RAM when the CMOS board is used as system/user RAM in the 16K–32K region. If you have only 1K installed in your ZX81, then a wire jumper JU3 should be inserted to tie \overline{RAMCS} to five volts, as shown in Fig. 12,

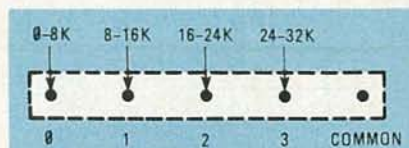

FIG. 9—JUMPER JU1 is used to determine which 8K block of addresses the RAM board will occupy. A jumper wire is inserted between the common pad and one of the other four pads.

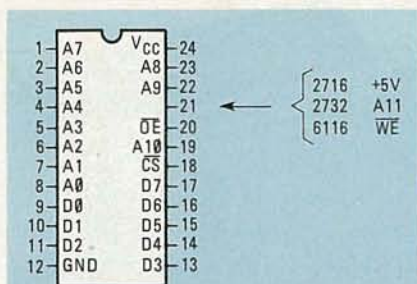

FIG. 10—PINOUTS OF THE MEMORY IC's are shown here. Only the function of pin 21 is different for the three different IC's discussed.

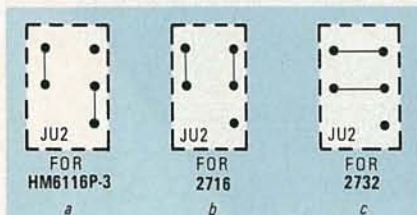

FIG. 11—JUMPER JU2 is used to select the proper pin connections for the different memory IC's.

and the socket for IC1 on the memory board should be used.

However, if you have a Timex/Sinclair 1000, or if you have upgraded your ZX81 to 2K by replacing the 2114 IC's with a 6116P memory IC, then position a diode in jumper JU3 as shown in Fig. 12 so that the internal memory will be disabled only when any location other than the first 2K (from 16K to 18K) is addressed. The socket for IC1 should then be left vacant.

If the board is used in the 8K to 16K slot (as system-transparent RAM), then a 1N4148 diode should be inserted for JU4. Then the ROMCS signal output from the CMOS RAM board will disable the system's 8K of ROM when any region other than the first 8K is addressed.

Using 2716 or 2732 EPROM's

If the board is to be fully populated with 2716 EPROM's, then resistors R2-R12, transistors Q1-Q5, diodes D1-D3, and the lithium cell should be omitted. Diode D3 should be replaced

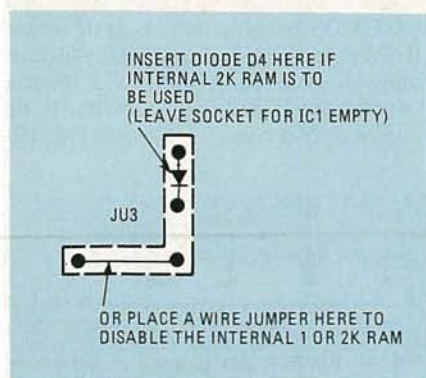

FIG. 12—JUMPER JU3 is used to disable the computer's internal RAM or to use its internal 2K RAM in place of IC1.

with a wire jumper, and wire jumpers should also be inserted to connect the collector and emitter pads of transistors Q2-Q5 together. Jumper JU2 should be positioned as shown in Fig. 11, and JU1 should be in position 1. Make similar modifications if 2732 EPROM's are to be used. The sockets for IC's 2 and 4 are used for the 2732 EPROM's, and jumpers JU2 are positioned as shown in Fig. 11.

To use as system RAM

When the board is used for system/user RAM, the battery backup is unnecessary, and the same modifications described above for 2716 EPROM's can be made. However, if you intend to vary the use of the board, then it's best to follow the instructions for assigning the board to the 8K-16K region. Then, changing over to system RAM is done very simply by changing JU1 to position 2 and adding JU3 as shown in Fig. 12. Note that if you use the board as system RAM, then you can use 2016 NMOS static RAM's in place of the more expensive CMOS IC's.

Testing the memory

The completed board should look like the one shown in Figs. 13 and 14. But looks are not enough—now you have to test the board to see whether it works!

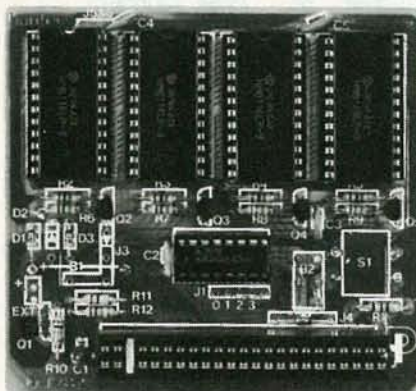

FIG. 13—THE COMPLETED BOARD. Note that jumper positions are labeled "J," not "JU".

If the CMOS RAM board is used in an 8K region between 16K and 24K, then the Timex/Sinclair system software can be used to test the memory. The top of system RAM is a variable, RAMTOP, that is stored in memory locations 16388 and 16389 (decimal). The command "PRINT (PEEK 16388 + 256 * PEEK 16389) / 1024 - 16; "K" " will print the size of system RAM—in this case 8K (in the absence of any other memory). (We should note here that the beginning and final quotes are ours and should not be typed in. That holds true whenever we mention a command in the text.)

If the CMOS RAM board is used in the 8K region from 8 to 16K, then a different procedure is required to test the memory. That's because the memory in that 8K block is not regarded by the Timex/

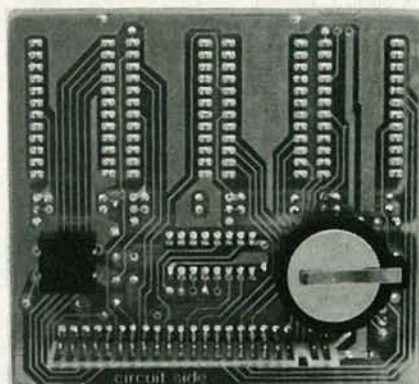

FIG. 14—THIS VIEW OF THE CIRCUIT SIDE OF the RAM board shows the only two components mounted there.

Sinclair as available system memory—in fact, the system doesn't know that it's there at all! The previous PRINT command (that PEEK's the RAMTOP variable) will produce the same result with or without the CMOS RAM board in the 8K to 16K block.

Therefore, to test the board in the 8K-16K slot, you will have to use a different program. Before we discuss that program—which is partly written in machine code—we will first discuss a program that you will need to use to enter such a machine-code routine.

That program—the one that will allow you to enter a machine-code routine—is shown in Table 2, and should be entered as written and then RUN. When prompted by the "L" cursor, enter the starting address of the machine-code routine. When prompted the second time, enter the data for that address. The address will be incremented automatically, so at the next "L" prompt, simply enter the data for the next address (without entering the address itself), and so on. To stop, simply enter an "illegal" character (any letter). Check for any errors, and correct them by simply POKE-ing the correct data into the address ("POKE address,data").

TABLE 2

100	INPUT A
110	INPUT D
120	POKE A, D
130	SCROLL
140	PRINT A, D
150	LET A = A + 1
160	GOTO 110

Now we can return to the memory-test program, which is shown in Table 3. First enter the BASIC program shown there, and then enter the machine code using the program in Table 2. Because you want to use that program before you use the BASIC program in Table 3, you should not type "RUN" after you have entered the two BASIC programs. Instead, to enter the machine-code program, tell the com-

puter to "GOTO 100," and *do not* hit "RUN" until after you have entered the machine code.

At this point, if all is well, the lithium cell can be placed in its holder. Slip it gently under the positive terminal, *positive side up*.

Write-protect switch

It is sometimes useful to be able to prevent writing over your nonvolatile memory—for example when testing a machine-language program for the first time. Jumper JU2, one of the OR gates in a 74LS32, and an external switch can be used as shown in Fig. 15 for write protection. It is also possible to protect and enable individual CMOS IC's in the same way.

Now that we have a working memory extension, it's time to look at some software that can be stored in it.

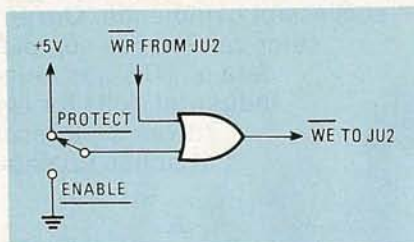

FIG. 15—WRITE PROTECTION can be easily added to the RAM board using the circuit shown here.

A sample display routine

The display file in the Timex/Sinclair 1000 does not occupy a fixed position. Instead, it moves around as the program length changes. If there is more than 3¼K of system/user RAM, then the graphics area of the display file normally consists of 704 characters (22 lines of 32 characters). In addition to those 704 characters, there is a code 118 at the beginning of the file, and a code 118 at the end of each line.

The routine in Table 4 can be used to store all of the characters in the display file in a predetermined memory location—in this example the area between 9000 and 9703 inclusive. The routine in Table 5 loads all of the data back into the display file, and the listing in Table 6 can be used to fill the stored display-file with a defined character that is POKE-d into memory-location 8236.

To experiment with the display routines, enter the machine code in Tables 4 through 6 into the corresponding memory locations. (Again, the BASIC program in Table 2 can be used to enter machine code quite quickly.)

Then enter the BASIC program shown in Table 7. That program fills the screen with a character (in this case the graphics character on the "T" key) and then dumps the display into the transparent region between 9000 and 9703. After you

TABLE 3

```
10 REM 123456789012345678901
20 PRINT "TRANSPARENT CMOS MEMORY";USR 16514/1024;"K"
30 STOP
```

Address	Data	Assembly language (Mnemonic)
16514	33 255 63	LD HL, (top of memory)
	1 0 0	LD BC, 00
16520	62 31	LD A, 31
	54 01	LD (HL), 01
	43	DEC HL
	188	CP H
	32	JNZ
	250	back 5 lines
	35	INC HL
	3	INC BC
16530	53	DEC (HL)
	40	JZ
	251	back 4 lines
	11	DEC BC
16534	201	RET

TABLE 4

Address	Data	Mnemonic
8192	42 12 64	LD HL (start of display file)
8195	17 40 35	LD DE (starting address of storage; 9000 decimal)
8198	62 22	LD A (number of lines in graphics area)
8200	35	INC HL
8201	1 32 0	LD BC (number of characters on a line)
8204	237 176	LDIR
8206	61	DEC A
8207	32	JNZ
8208	247	back 8 lines
8209	201	RETURN

TABLE 5

Address	Data	Mnemonic
8210	237 91 12 64	LD DE (start of display file)
8214	33 40 35	LD HL (storage location starting address; 9000 decimal)
8217	62 22	LD A (number of lines in graphics area)
8219	19	INC DE
8220	1 32 0	LD BC (number of characters on a line)
8223	237 176	LDIR
8225	61	DEC A
8226	32	JNZ
8227	247	back 8 lines
8228	201	RETURN

TABLE 6

Address	Data	Mnemonic
8229	33 40 35	
8232	1 192 2	LD BC (number of characters in display; 704)
8235	54	LD (HL) (code for character to be displayed)
8236	128	(other characters may be poked into this address)
8237	35	INC HL
8238	11	DEC BC
8239	120	LD A,B
8240	177	OR C
8241	32	JNZ
8242	248	back 7 lines
8243	201	RETURN

TABLE 7

```
10 FOR N = 1 TO 704
20 PRINT █
30 NEXT N
40 RAND USR 8192
```

TABLE 8

```
10 FOR N = 1 TO 63
20 POKE 8236,N
30 RAND USR 8229
+ USR 8210
40 NEXT N
```

NTS Electronics

Learn Robotics, Microcomputers, Microprocessors, Digital Video, Test Equipment and more with NTS INTRONIC™ home training. Courses include state-of-the-art equipment, lessons and texts to make your hands-on programs exciting and down-to-earth practical.

HERO 1 is included in two courses, one basic and one advanced. You'll cover principles of industrial electronics, microprocessor troubleshooting, fundamentals of mechanics, and robotic applications in industry. You'll learn analog and digital skills, radio control, fluidic, pneumatic and servo-mechanisms, as well as computer interfacing and robotic programming. HERO 1, complete with arm, gripper and speech synthesis board, is a fully self-contained electro-mechanical robot—the featured unit in the most exciting training programs ever offered in home study.

NTS Intronic Training is a carefully developed and tested learning system providing a thorough intergration of advanced electronic hardware with modern lesson texts. The relationship between theory and practical applications is made clear through the hands-on experience of building and assembling kits of state-of-the-art equipment. Courses include a wide variety of test instruments, both digital and analog, as well as other units not shown here. And, depending on the NTS program you select, you can earn up to 30 CEU credits for successful completion. Our full-color catalog has complete details. NTS has taught industrial skills for over 78 years—a record that has no equal.



Training.....

FIRST WITH TOMORROW'S TECHNOLOGY

1. **Advanced "Z Chassis" NTS/HEATH "Smart Set"** with computer space command remote control and space phone. Originate or receive telephone calls through this set and the number appears on the screen-store your police and other emergency numbers into memory which may be recalled and auto-dialed at any time. Traditional and incomparable picture quality. Unit has Quartz Controlled Tuning, 178 channel capacity, remote antenna switch accessory for reception of VCR, VDR, Broadcast, Cable, Video Games, and Personal Computer Input (no cable change) plus computer-controlled color. Featured in all-new Video Technology Course.

2. **NTS/HEATH HN89A Microcomputer** is included in two programs. This famous and reliable unit features Floppy Disc Drive, 48K Memory on Board, CRT Terminal with its own Z-80 Processor, and standard keyboard as well as Numerical Input Keyboard. The growing importance of computer knowledge and skills have made these programs increasingly significant. The experience gained in assembling these kits is invaluable in the understanding of computer troubleshooting skills.

NTS Microprocessor Trainer is included in our Industrial and Microprocessor Technology Course. It is a portable unit, contained in a convenient high-impact carrying case. Hardware/software includes Monitor Operating System-Expandable User Memory-User Experimental On-board Section-Breakpoint Editor-Single Step Trace-cassette I/O.

NO OBLIGATION

NO SALESMAN WILL CALL

NTS NATIONAL TECHNICAL SCHOOLS

TECHNICAL TRADE TRAINING SINCE 1905
 Day and Home-Study Schools
 400 So. Figueroa St., Los Angeles, CA 90037

Simulated TV Reception



Use the mail-in card or fill out and mail the coupon. Indicate the field of your choice. (One, only please.) FREE full color catalog will be sent to you by return mail.

NATIONAL TECHNICAL SCHOOLS Dept. 206-083
 4000 South Figueroa Street, Los Angeles, CA 90037

Please send FREE color catalog on course checked below:

- | | |
|---|---|
| <input type="checkbox"/> Robotics | <input type="checkbox"/> Computer Electronics |
| <input type="checkbox"/> Digital Electronics | <input type="checkbox"/> Video Technology |
| <input type="checkbox"/> Auto Mechanics | <input type="checkbox"/> Home Appliances |
| <input type="checkbox"/> Air Conditioning/Solar Heating | |

Name _____ Age _____

Address _____

Apt. _____ City _____

State _____ Zip _____

- Check if interested in G.I. information.
 Check if interested ONLY in classroom training in Los Angeles

AUGUST 1983

run the program, reset the computer or type "NEW" to clear the system. With the computer cleared and with more than 3¼K of memory, enter "RAND USR 8210." Your original display will reappear. If you don't have a RAM pack (and thus don't have the 3¼K of RAM) you must first expand the display file by filling the screen or by POKE-ing an artificially high value into the location for the variable RAMTOP. For example, without a RAM pack, first enter "POKE 16389,80" and then enter the command "RAND USR 8210."

Now try the program in Table 8. It fills the screen with all of the characters from 1 to 63 in the character set by using the routines in Tables 5 and 6. It will give you an idea of how fast you can change the entire display. One advantage of having a secondary-display file in memory is that it lets you make changes to the file over a period of time and then to display all of the changes simultaneously on the screen.

Saving machine-code routines

Occasionally it is possible to lose the contents of the nonvolatile memory. That can happen due to a fault in a machine-language program under development, if the battery fails, or because of a transient in the power supply—usually during power-up or power-down. (It might be a good idea to hold down the RESET switch on the 8K memory board when switching the computer off—at least until you determine that it's safe not to—because it protects the nonvolatile memory from being overwritten.) In any event, it is advisable to save the contents of the nonvolatile memory on tape as a backup. Re-entering machine code by hand can be extremely tiresome and frustrating.

The SAVE command does not save any programs that are stored in the transparent region, so the contents of the 8K–16K region must be moved up into the system/user RAM and then SAVE-d. The only restriction to the following procedure is to make sure that the machine code contains no code 118 (decimal). That is because the 118 is recognized by the system as the end of a statement. Make note of any 118's and replace them temporarily with zeros.

Next, enter the program in Table 9. Then enter in the REM statement of line 10 the machine code of Table 10. If you use a

TABLE 9

10	REM 123456789012345678 90123456789012345
12	INPUT N
14	POKE 16516, INT (N/256)
16	POKE 16515, N - 256*INT (N/256)
18	RAND USR 16514
20	REM

TABLE 10

Address	Data	Mnemonic
16514	1 0 0	LD BC (size of REM statement)
16517	3	INC BC
	3	INC BC (add 2 for REM and CODE 118)
16519	42 12 64	LD HL (start of display file)
16522	43	DEC HL
	43	DEC HL
	43	DEC HL
	43	DEC HL (point to size of REM statement)
16526	113	LD (HL), C
	35	INC HL
	112	LD (HL), B (load size of REM statement)
	35	INC HL
16530	35	INC HL (point to address for new character)
	11	DEC BC (decrease BC to number of characters)
	11	DEC BC (to be entered)
	197	PUSH BC
	229	PUSH HL
16535	205 158 9	CALL (move everything up one to make room for a new character)
16538	225	POP HL
16339	193	POP BC
16540	54 23	LD (HL), (character *)
16542	35	INC HL
	11	DEC BC
	120	LD A, B
	177	OR C
	32	JNZ
	248	(back 7 lines)
16548	201	RETURN

TABLE 11

Address	Data	Mnemonic
16514	33 0 32	LD HL (start of transparent RAM; 8192)
16517	17 160 64	LD DE (start of area in REM statement; 16544)
16520	1 0 8	LB BC (size of block to be transferred; 2048)
16523	237 176	LDIR
16525	201	RETURN
16526	33 160 64	LD HL (start of area in REM statement; 16544)
16529	17 0 32	LD DE (start of transparent RAM; 8192)
16532	1 0 8	LB BC (size of block to be transferred; 2048)
16535	237 176	LDIR
16537	201	RETURN

BASIC program like the one in Table 2 to enter the machine code, remember to delete it. Enter "RUN." When prompted, enter the amount of memory whose contents you want to save (*n*)—usually 2048 (2K) or 8192 (8K). The program takes less than 1 second for 8K. When you now list the program you will see that the REM statement on line 20 contains *n* asterisks.

The next step is to delete lines 10 through 18 and enter a REM statement with 24 characters as line 10. Then enter the machine code in Table 11. Those routines assume that the size of the block to be transferred is 2K. For transfers of 8K, change lines 16522 and 16534 to "32."

You can use a BASIC program to enter the machine code (for example at line 100) but *do not* attempt to delete or insert any line immediately following the REM statement on line 20.

You now have a program consisting of two REM statements. The REM statement on line 10 should now contain the machine code from Table 11. The REM state-

ment on line 20 should contain either 2048 or 8192 asterisks. Save the program on tape for future memory dumps.

To transfer the specified block of system-transparent memory up into the system RAM (so that you can save it), enter "RAND USR 16514." Then SAVE "NAME" on tape. To reload the routines into the 8K–16K region, reload from the tape as normal, enter "RAND USR 16526" and then enter "NEW" to clear the system. *Don't forget* to re-POKE any original 118's that you replaced with zeros.

Merging programs

Merging programs is not impossible with the Timex or ZX81 system, but it is tedious. It requires reserving memory outside the BASIC system by POKE-ing a new value for the variable RAMTOP, transferring one program into that reserved area, loading the second program from tape, and then transferring the first program back into the computer's BASIC system.

The CMOS RAM board allows you to store and merge programs or data quite easily—using machine-language routines resident in the DMOS memory. (You'll have to enter the two machine-code programs in Tables 12 and 13.)

The routine in Table 12 is used to dump a program from the BASIC system to the CMOS RAM. The contents of all memory (both programs and variables) from the start of user memory (16509) to the start of the display file is dumped. To check the size of the program (to make sure that it will fit in the CMOS RAM) before executing the routine, use the command "PRINT (PEEK 16396 + 256*PEEK 16397 - 16509)/1024; "K". The number of bytes is stored by the routine in location 9000 and 9001 and the program and data are stored starting at location 9003 (after a code 118 at location 9002). Those locations can be changed if you wish. You can also modify the routine to dump only a portion of the user memory (for example, just the program or perhaps just the variables). The command "PRINT USR 8244" will execute the dump and respond with a 0 upon completion.

After storing one program in the CMOS RAM, the system can be cleared and a second program loaded from tape. Make all of the line numbers in the second program loaded from tape less than the lowest line number in the first BASIC program. Line numbers from the stored program should not be duplicated—the BASIC program in Table 14 can be used for renumbering. (It is also a good example of a program that might be useful to store in the system-transparent RAM.) Enter the command "IF USR 8269 = 0 THEN STOP." That is necessary to prevent the execution of the program after reloading.

The merge routine can also be used to store a BASIC program in the CMOS RAM. However, you must remember to enter a line like "I REM" before moving the stored program back up to the system RAM. (You can delete it once it is back in the user memory.)

Free space

The amount of free space in memory is the "spare" memory between the top of the calculator stack and the bottom of the machine stack. (See page 128 of your manual.) The top of the calculator stack is stored as the system variable STKEND. The bottom of the machine stack is always pointed to by the Z80 register SP (stack pointer). The routine in Table 15 simply subtracts one from the other. To determine the amount of free memory in your system, enter the machine-code program in Table 15 and then enter the command "PRINT USR 8297." The result that you will see will be the number of free bytes.

As suggested in the introduction, there

TABLE 12

Address	Data	Mnemonic
8244	17 125 64	LD DE (start of program area; 16509)
8247	42 12 64	LD HL (start of display file)
8250	183	OR A (clear carry flag)
8251	237 82	SBC HL, DE
8253	68 77	LD B, H and LD C, L
8255	33 40 35	LD HL (start of storage area; 9000)
8258	113	LD (HL), C
8259	35	INC HL
8260	112	LD (HL), B
8261	35	INC HL
8262	54 118	LD (HL), (code 118)
8264	35	INC HL
8265	235	EX DE, HL
8266	237 176	LDIR
8268	201	RETURN

TABLE 13

Address	Data	Mnemonic
8269	237 75 40 35	LD BC (size of program)
8273	42 12 64	LD HL (start of display file)
8276	43	DEC HL
8277	197 229	PUSH BC; PUSH HL
8279	205 158 9	CALL routine at 2462 decimal
8282	209 193	POP DE; POP BC (note exchange)
8284	33 42 35	LD HL (start of storage area; 9002)
8287	237 176	LDIR
8289	201	RETURN

TABLE 14

```

9900 REM LINE RENUMBER
9905 PRINT "NOTE GOTO AND GOSUB ADDRESSES"
9910 PRINT
9915 PRINT "ENTER NUMBER FIRST LINE WILL BE"
9920 INPUT F
9925 PRINT
9930 PRINT "ENTER LINE INCREMENT"
9935 INPUT I
9940 PRINT
9945 LET N = 16509
9950 POKE N, INT (F/256)
9955 POKE N+1, F - 256*INT (F/256)
9960 REM POINT TO NEXT LINE
9965 LET N = N + PEEK (N+2) + 256*PEEK (N+3) + 4
9970 IF 256*PEEK N + PEEK (N+1) = 9900 THEN GOTO 9990
9975 LET F = F+I
9980 GOTO 9950
9990 PRINT "LAST LINE IS ";F;

```

TABLE 15

Address	Date	Mnemonic	
8297	33 0 0	LD HL, 00	Clear HL
8300	57	ADD HL, SP	Move SP to HL
8301	237 91 28 64	LD DE (Stkend)	
8305	237 82	SBC HL, DE	Carry flag already cleared
8307	68 77	LD B, H and LD C, L	
8309	201	RETURN	

are many other routines like these that you can devise to expand the versatility of the Sinclair BASIC system. You might consider only partially populating the board with one HM6116P CMOS memory IC initially—even 2K of system-transparent memory is extremely useful. We've discussed several useful programs that can be stored in the nonvolatile RAM. But as you can see, the software does not occupy much of the space that is available.

Before we finish up, a word of caution: If you use this memory expansion along

with the 16K RAM pack, be sure to use the programs we discussed earlier to save the contents of the 8K system-transparent region. As you are probably aware, the poor design of the Timex RAM pack connector can be the cause of frequent system crashes. While any crash is annoying, it is even worse in this case. It's bad enough to lose BASIC that is stored in the 16K RAM, but there is nothing more frustrating than having 8K of machine code that you stored in nonvolatile RAM overwritten by garbage.

R-E

BUILD THIS

Digital TEMPERATURE GAUGE

FRED L. YOUNG, SR. and
FRED L. YOUNG, JR.

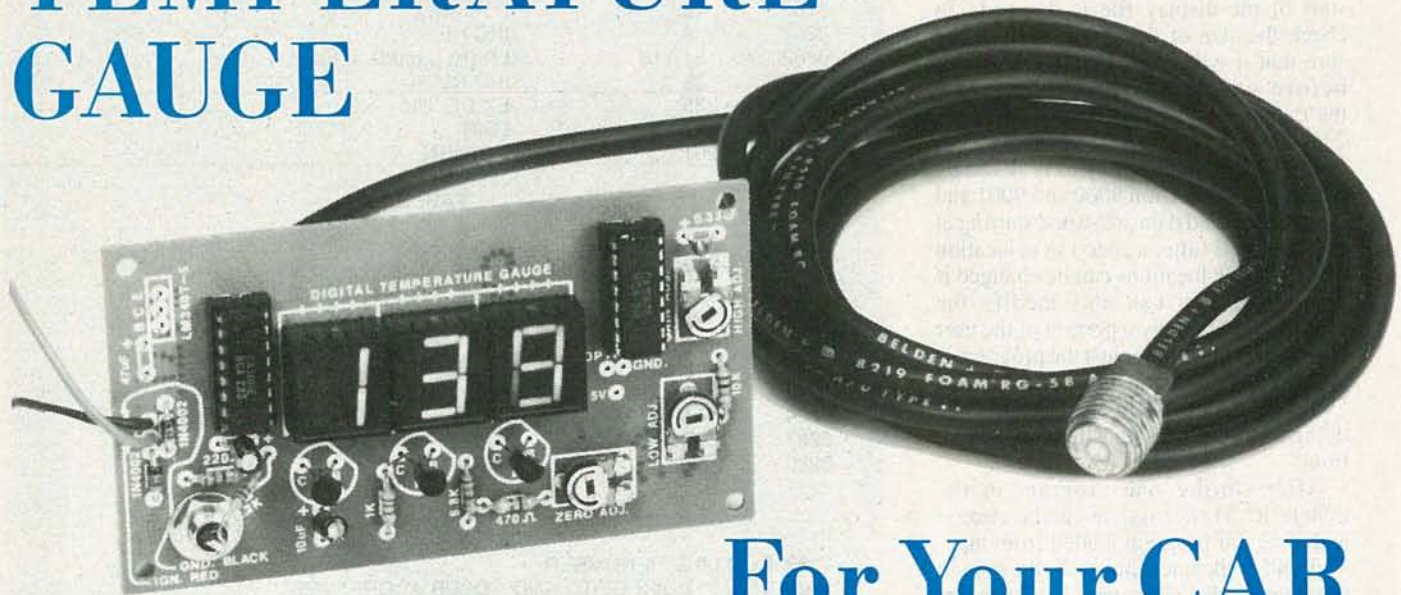

For Your CAR

This is the time of year when automobile engines start to overheat and leave angry motorists stranded by the roadside. This digital temperature gauge for your car will see to it that you're not one of them.

LAST MONTH WE DESCRIBED A DIGITAL voltmeter for your car (or other vehicle) based on the CA3161E and CA3162E IC's. This month we'll use the same IC's to build a digital thermometer that can be used to monitor your car's engine temperature, or in any of many other temperature-measurement applications.

The thermometer's circuit is similar in many respects to that of the voltmeter, and we suggest that you refer to the July 1983 issue of **Radio-Electronics** for a complete description of its operation.

A schematic of the thermometer is shown in Fig. 1. In essence, IC2, a CA3162E dual-slope, dual-rate analog-to-digital converter, translates an incoming analog signal (we'll discuss its source in a moment) into a digital BCD (Binary-Coded Decimal) number. Then, IC3, a CA3161E, converts that number into signals that cause the segments of DISP1-DISP3 to light up in certain patterns to form numbers. The CA3161E is known as a BCD-7-segment decoder/driver. The power for the entire circuit is derived from IC1, a 340T-5 five-volt regulator.

The temperature probe itself is ridiculously simple—it's just a 1N4002 or 1N914 (1N4148) diode at the end of a piece of coaxial cable. Diodes (and other semiconductor junction-devices) have an

unusual—but very useful—characteristic: the forward voltage across them drops as the temperature increases. In the case of diodes, the rate of change is about two millivolts per degree Fahrenheit. The rate of change is linear over a respectable temperature range, and this temperature gauge is accurate from well below zero up to 250°. All we have to do is apply a voltage to the diode and measure the forward voltage, which is then converted by the rest of the circuit into a temperature reading.

(One word of caution, though: If you ever have to change probes, the gauge will have to be recalibrated. While any diode you use will have the same rate of change, each will have a different "base point" from which it is referenced, and recalibration will be necessary to take that into account.)

Construction

Before you start mounting parts on the board, you should prepare the piece of red plastic that will protect the board and display. The plastic should be 1/8-inch thick and just a little larger in area than the circuit board. Place the plastic under the board and, with a sharp point, mark the position of the four mounting holes in the board on the plastic. Then, make a hole at

each position for the 4-40 mounting hardware (drill a small pilot hole, and then carefully enlarge it; that way you won't crack the plastic). Temporarily set the plastic aside.

A foil pattern for the digital temperature-gauge circuit board is shown in Fig. 2. If you would rather purchase a ready-to-use board than make your own, see the Parts List for the supplier.

Techniques for PC-board construction were discussed in detail in the article the digital voltmeter, and if this is your first project, you will gain a lot by reading it before you start building.

Figure 3 shows a parts-placement diagram for the board. It's advisable to use sockets for IC2 and IC3; install them first, then the resistors, followed by the capacitors. Do not install IC2 or IC3 until after your initial board-checkout. When you mount the three 7-segment LED's, DISP1-DISP3, solder only two pins at opposite corners at first. That will permit you to adjust their positions fairly easily if you don't put them in straight the first time. Be sure that the ridges at the tops of the LED's face the way shown in the diagram. When you install jack J1, you may have to enlarge the hole in the board so it can fit through. Use a lockwasher on the foil side of board both to keep the jack

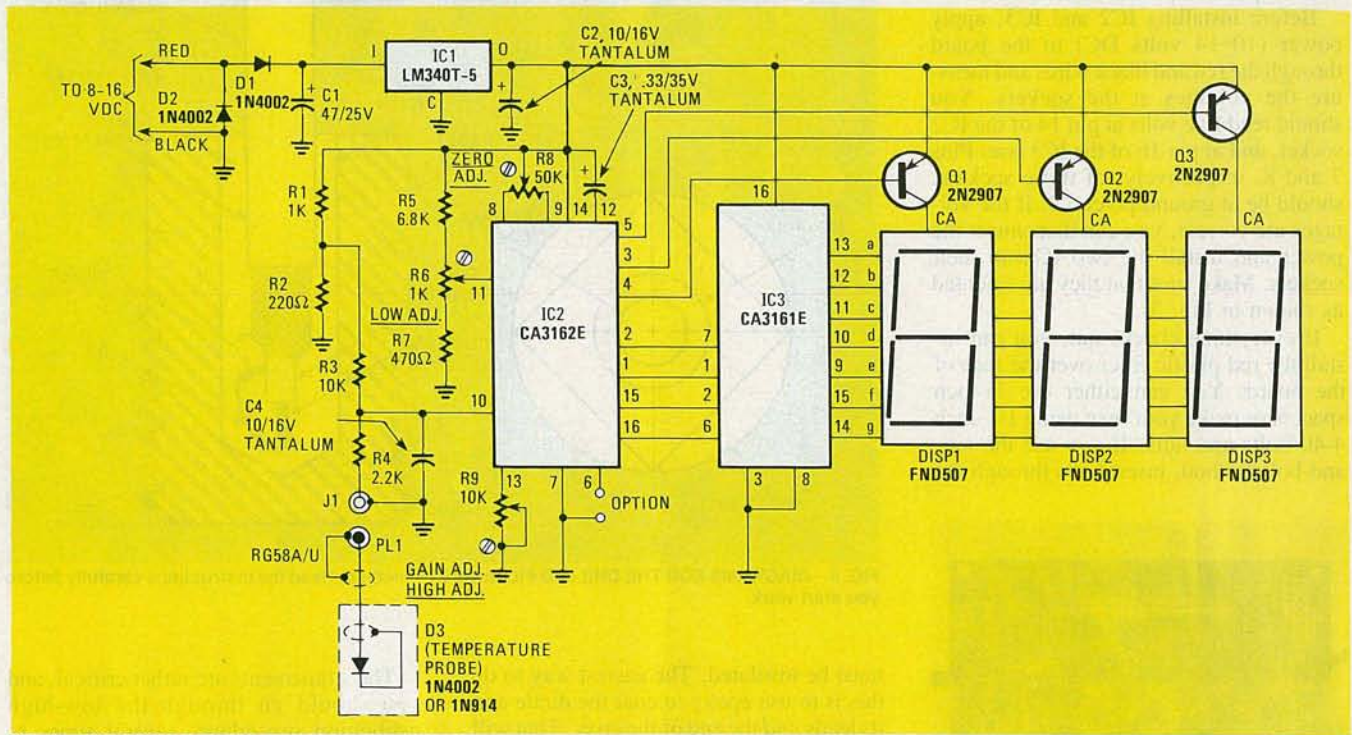

FIG. 1—THE BASIC DIGITAL TEMPERATURE GAUGE consists of a probe, an A/D converter (IC2), a 7-segment LED decoder/driver (IC3) and, of course, the display LED's themselves.

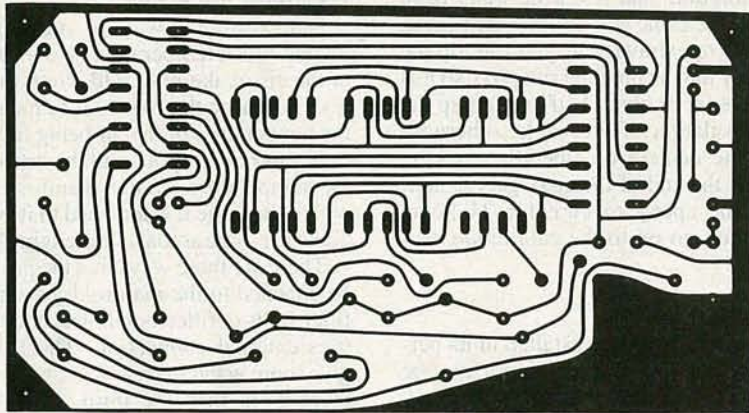
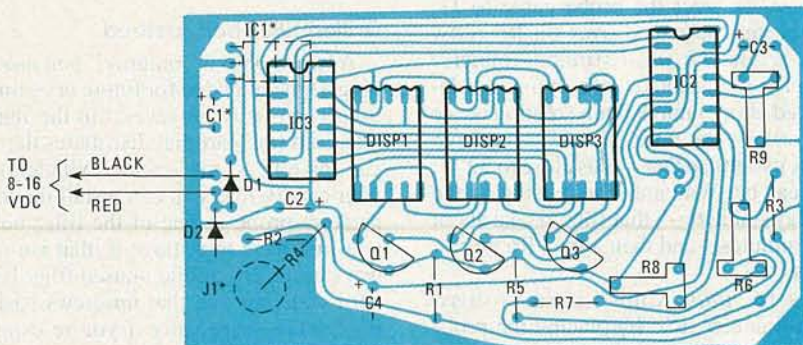

FIG. 2—YOU CAN ETCH this single-sided PC board yourself, or buy it from the source indicated in the Parts List.



*MOUNTED ON FOIL SIDE OF BOARD

FIG. 3—TWO COMPONENTS (indicated by dashed lines) mount on the foil-side of the board: they are IC1 and C1.



FIG. 4—BEND IC1 OVER BACKWARD on the bottom of the board as shown.

from working loose and to make sure that it makes good electrical contact with the foil. Note that the "business end" of the jack is on the foil side of the board. Connect resistor R4 from the center lug of the jack to the board.

The last two components to be installed (except for the two IC's) are IC1 and C1. They should be mounted on the foil side of the board, as shown in Fig. 4. That is done to keep the total height of the component-side of the board down. Make sure that the regulator is arched over backward as shown, but that its case does not contact the board. (A piece of electrical tape on the board beneath the regulator to act as insulation will make sure of that!)

Finally, connect three-foot lengths of

red and black wire to the points on the board indicated in Fig. 3; they will be used to provide power to the circuit.

Before installing IC2 and IC3, apply power (10–14 volts DC) to the board through the red and black wires and measure the voltages at the sockets. You should read five volts at pin 14 of the IC2 socket, and at pin 16 of the IC3 one. Pins 7 and 8, respectively, of those sockets, should be at ground potential. If the voltages are correct, you can disconnect the power and install the two IC's in their sockets. Make sure that they are oriented as shown in Fig. 5.

If everything checks out, you can install the red plastic filter over the face of the board. You can either use 3/4-inch spacers or make your own using 1 1/2-inch 4-40 bolts and nuts. If you use the nut-and-bolt method, insert bolts through the

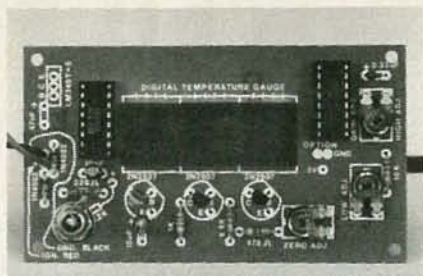

FIG. 5—THE COMPLETED circuit board should look like this. Note the mounting of J1 and how R4 is connected to it.

plastic, and secure them with nuts on the reverse side. Then screw a second nut onto each bolt, allowing 3/4 inch of space between it and the first one. Insert the bolted-plastic assembly into the holes in the PC board, and secure it with four more nuts.

With that done, you are ready to build the temperature probe and calibrate unit.

Probe construction

The temperature probe, D3, can be a 1N4002, 1N914, or 1N4148 diode. Keeping the leads short, attach it to one end of a length of RG58A/U coax as shown in Fig. 6. The coax should be long enough to reach from the probe location to the point where the display will be mounted, and should have enough slack to allow it to be routed around areas of the engine compartment that get particularly hot, like the exhaust manifold, and away from the spark-plug wires.

The cathode (banded) end of the diode should be soldered to the shield of the coax, and the anode to the center conductor. Make sure that the shield of the coax does not touch the center conductor (twisting and tinning the end of the braid will help avoid that). The other end of the coax—the end that will be connected to the circuit board—should receive an RCA-type plug, PL1.

To avoid errors and contamination during the calibration, the probe assembly

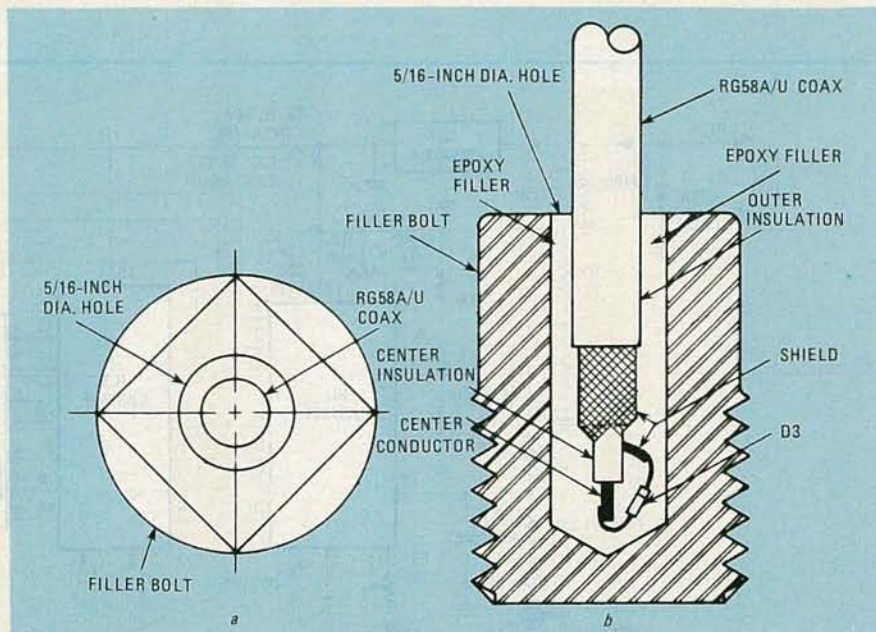

FIG. 6—DIAGRAMS FOR THE DRILLED FILLER-BOLT method. Read the instructions carefully before you start work.

must be insulated. The easiest way to do this is to use epoxy to coat the diode and its leads and the end of the coax. That will prevent any current leakage when the probe is immersed in the water baths used for calibration, and will keep water from entering the cable and possibly damaging it. If you're extravagant, you can dip the assembly into a container of epoxy so it is coated as far as about half an inch up the outer insulation of the cable; otherwise smear the cement on liberally, making sure that the end of the coax gets sealed. Allow the epoxy to cure for 24 hours before you go on to the calibration procedure.

Calibration

Before the probe is installed in its permanent location, the meter circuit must be calibrated. *Without the probe connected*, apply 10–14 volts to the circuit board through the red (+) and black (–) wires; 13.8 volts is recommended. Temporarily ground pins 10 and 11 of IC2 and adjust R8 (ZERO ADJUST) until the display reads "000." Then unground the two IC pins.

Next, connect the probe cable to J1, and center the wiper arms on R6 (LOW ADJUST) and R9 (HIGH ADJUST). Immerse the probe (insulated with epoxy as described above) into a plain solution of ice and water—the water should come from ice as it melts so that it is as close to 32° F. as it can be. Wait until the reading on the display stabilizes—that should take about five minutes—and then adjust R6 until it reads "032."

Set the HIGH ADJUST (GAIN ADJUST) potentiometer, R9, by placing the probe in boiling water—again, wait about five minutes until the display stabilizes—and adjusting the control until you read "212."

The adjustments are rather critical, and you should go through the low-high calibration procedures several times to eliminate as much error as you can.

Mounting the probe

The simplest way to measure the engine-block temperature is to measure it at the air-intake manifold. Note that that does not mean that you will be measuring the temperature of the air being fed to the engine—rather, you will be measuring the temperature of the manifold itself, which, because it is attached to it, will be about the same as that of the engine block.

There are three ways that the probe can be attached to the manifold: two involve filler-bolts or filler-bolt holes, and the last uses external connection. The first two give more accurate readings, but involve more work than the third. If you have difficulties with the filler-bolt methods, and are willing to put up with somewhat less accuracy (on the order of several degrees), then the external-connection method can be used. Study all the methods before you make your decision.

Drilled filler-bolt method

A filler bolt is a "dummy" bolt used to plug a hole intended for future or optional use. There may be several in the intake manifold (the part that distributes the air/gas mixture to the engine cylinders) of your car. Before you can install the temperature probe in one of the filler bolts, you first have to remove it; that isn't always easy. Try all the unused filler bolts until you find one that unscrews easily. Be careful—especially if you're using a long-handled socket wrench—not to apply too much force. Doing so can shear the bolt, strip its threads, or it can even crack the manifold.

PARTS LIST

All resistors 1/4 watt, 5% unless otherwise indicated

- R1—1000 ohms
- R2—220 ohms
- R3—10,000 ohms
- R4—2200 ohms
- R5—6800 ohms
- R6—1000 ohms, trimmer potentiometer
- R7—470 ohms
- R8—50,000 ohms, trimmer potentiometer
- R9—10,000 ohms, trimmer potentiometer

Capacitors

- C1—47 μ F, 25 volts, electrolytic
- C2, C4—10 μ F, 16 volts, tantalum or electrolytic
- C3—0.33 μ F, 35 volts, tantalum

Semiconductors

- IC1—LM340T-5 (7805) positive 5-volt regulator
- IC2—CA3162 dual-slope, dual-speed, A/D converter
- IC3—CA3161 BCD-7-segment multiplexing decoder/driver
- DISP1—DISP3—FND507 (FND510) 0.5-inch 7-segment LED, common anode
- D1, D2—1N4002
- D3—1N4002 or 1N914 (1N4148)
- J1—RCA phono jack
- PL1—RCA phono plug

Miscellaneous: PC board, RG58A/U coax, epoxy, etc.

The following are available from Digital World, PO Box 5508, Augusta, GA 30906: temperature gauge PC-board only, \$7.50; temperature gauge PC board with schematic & diagrams, \$8.50; IC2 and IC3, \$12.00; PC board and IC1-IC3, \$20.00; kit of all parts including coax (does not include plastic, solder or chassis), \$32.50. The first two items (PC board and PC board with schematic & diagrams) are postpaid within the continental U.S.; all other items add \$2.00 shipping & handling. APO, FPO, and other U.S. add \$3.00. Canadians add \$3.00 (please use U.S.-dollar money order). All others write for prices and shipping costs. Please allow 4 to 6 weeks for delivery.

Sometimes, applying some penetrating oil and allowing it to work overnight will allow you to remove a frozen- or rusted-in filler bolt with several light taps and the gentle application of force. If none of the bolts can be removed conveniently, you'll have to connect the probe externally, as described below.

With a bolt removed, use a drill press to drill a 5/16-inch hole in it from the outside to the inside (naturally). Refer again to Fig. 6 (The completed filler-bolt assembly is shown in Fig. 7). The hole should be deep enough to hold the diode and a "dab" of retaining epoxy, but must stop 1/8-inch short of the end of the bolt. If you drill through the end, you'll have to start over with another bolt; it might be a good idea for you to practice on a non-essential



FIG. 7—COMPLETED FILLER-BOLT probe with cable attached.

piece of material similar to the bolt first, to get a "feel" for the procedure.

Mix a batch of quick-setting epoxy and fill the hole half-full with it. You'll have to work fairly quickly—after five or ten minutes the epoxy starts to set and becomes difficult to work with.

Then insert the diode assembly into the epoxy in the hole in the bolt until it makes contact with the bottom of the bolt. Now slowly and gently pull on the coax to lift the diode until it is no longer in contact with the bolt. That's just to make sure that the probe will not short out to the bolt even if there's a defect in the probe's epoxy "insulation." A change in position of about 1/8-inch should be enough. Stop! Hold the probe in that position for at least ten minutes, until the epoxy has set enough to be firm.

When the epoxy has started to set, any excess that may have been forced out of the hole can be removed carefully. Allow the epoxy to cure for 24 hours at a temperature between 60° and 90°F. Finally, after the epoxy has cured, check the cable with an ohmmeter to make certain that the probe has not shorted to the bolt. Reinsert the bolt in the manifold, and proceed to the "Installation" section.

Filler-bolt hole method

If you are unable to remove any of the filler bolts, the probe can be inserted in an unused filler-bolt hole in the intake manifold. The hole should be cleaned thoroughly and any accumulated oil or rust removed—epoxy needs a clean surface to bond to and any foreign matter could prevent a solid adhesion and result in the probe's working loose and coming out.

Make sure the engine is cool—not only could you get burned otherwise, but some epoxies are flammable, and could catch fire if applied to a hot surface. The angle of the hole may present a problem in getting the epoxy in and keeping it in; it may be necessary to build up a shelf of wax around the lower rim of the hole to ensure that enough epoxy is retained to encapsulate the probe and to grip the probe-end of the coax securely.

Mix the epoxy and force an amount into the bottom of the hole by using a wooden dowel of about the same diameter as the hole. The hole should be filled completely to make certain that there's enough cement to hold the probe and

cable. The rest of the procedure is essentially the same as that given for the "drilled filler-bolt" method: insert the probe so it's about 1/8 inch from the bottom of the hole and allow the epoxy to set and cure while using an ohmmeter to make sure that the probe doesn't short to the side or bottom of the hole. After the epoxy has cured, proceed to the "Installation" section.

External probe-attachment

If neither of the first two methods will work for you, then the probe can be epoxied to the outside of the intake manifold.

Clean the selected surface well so that the epoxy will bond firmly to it and mix some epoxy (do not mix it all; you'll need more shortly). Apply a coating about 1/8-inch thick to an area about 1 1/2-inches square to form a mounting base. Let the cement harden for 20-30 minutes and then mix a second batch of epoxy. Tape the probe/coax assembly in place and use the second batch of epoxy to encapsulate it. Use your ohmmeter to make sure that the probe is not shorting out to the surface on which it's mounted. After the epoxy has cured, you may proceed to the "Installation" section.

Installation

The temperature gauge can be installed either in the dashboard of your car, or in a separate enclosure. The cable from the probe can be routed through a hole in the firewall; you can later seal the hole around the cable to keep dust, water, and fumes out of the car. Remember to plug the probe cable into the board—otherwise you'll go crazy trying to figure out why the gauge doesn't work.

A good place to obtain power for the gauge is from the same fuse terminal to which your car's radio is connected. The red wire should go there, and the black wire to the car's body (so there is a return to the negative post of the battery).

If you find that the operation of the gauge creates interference on your AM radio, there are several "fixes" you can try to get rid of it.

First, try connecting the gauge to a power source other than the radio's fuse. You can also try locating the gauge a distance away from the radio itself. Finally, if the circuit board is not in an enclosure, add one, made of metal and grounded; this solution is usually quite effective.

A last word of advice: Don't disconnect your present temperature gauge or warning light—it's always a good idea to have a backup!

The use of this gauge is not limited to your car, of course. You can use it to monitor the temperature inside your freezer, for example, or just as an electronic indoor or outdoor thermometer. However you use it, you'll find that its speed, accuracy, and readability make it a valuable instrument to have. **R-E**

NEW IDEAS

Ultrasonic pest repeller

PEST CONTROL HAS BEEN BROUGHT INTO the electronic age by the introduction of the ultrasonic insect repeller. That device is said to repel—not kill—unwanted flying and crawling pests by emitting ultrasonic sound waves that sweep between 65,000 and 25,000 hertz. The sound is apparently rather irritating to them.

I went shopping for one of those "miracle" devices but I was repelled—by their prices, which ranged from \$49 to \$69. Therefore I decided to design and build my own. The circuit I came up with, which should cost about \$20 to build, is shown in Fig. 1.

The repeller is designed around a 556 dual timer. One half is operated as an astable multivibrator with an adjustable frequency of 1 to 3 Hz. The second half is also operated as an astable multivibrator but with a fixed free running frequency around 45,000 Hz. The 25–65 kHz sweep is accomplished by coupling the voltage

across C2 (the timing capacitor for the first half of the 556) via Q1 to the control voltage terminal (pin 11) of the second half of the 556.

Transistor Q1 serves two purposes: it isolates the timing circuit of the first half of the 556 from pin 11 and it controls an LED indicator. When the first half is operating, timing capacitor C2 continually charges and discharges between $\frac{1}{3}$ and $\frac{2}{3}$ the supply voltage. Because the base of Q1 is tied to C2, the voltage across C2 will affect the operation of Q1. The voltage at the base of Q1 causes it to conduct, thereby turning on the LED and lowering the control voltage that is applied to pin 11. The lower control voltage causes the output frequency of that half of the timer to increase to around 65 kHz. As C2 is charged toward $\frac{2}{3}$ volt, Q1 conducts less and less. That causes the intensity of the LED to decrease and the control voltage applied to pin 11 to increase, because

Q1's emitter approaches +V. The increasing control voltage causes the output frequency to decrease from 65 kHz to 25 kHz. That sweep will take from 1 to $\frac{1}{3}$ second depending on the setting of R1. Theory has it that periodic adjustment of the sweep rate will prevent the pests from developing an immunity to the sound.

The device that radiates the ultrasonic sound is a piezo tweeter. Radio Shack sells several models ranging in price from \$9 to \$15.

Because the output of the repeller is above the range of human hearing, it is difficult to determine whether it is operating properly. If S1 is closed, though, the output frequency is lowered so that it can be heard. The output of the piezo tweeter is intense so, if you get tired of the repeller, you can switch C4 permanently into the circuit and turn the repeller into one heck of an alarm.—David L. Holmes

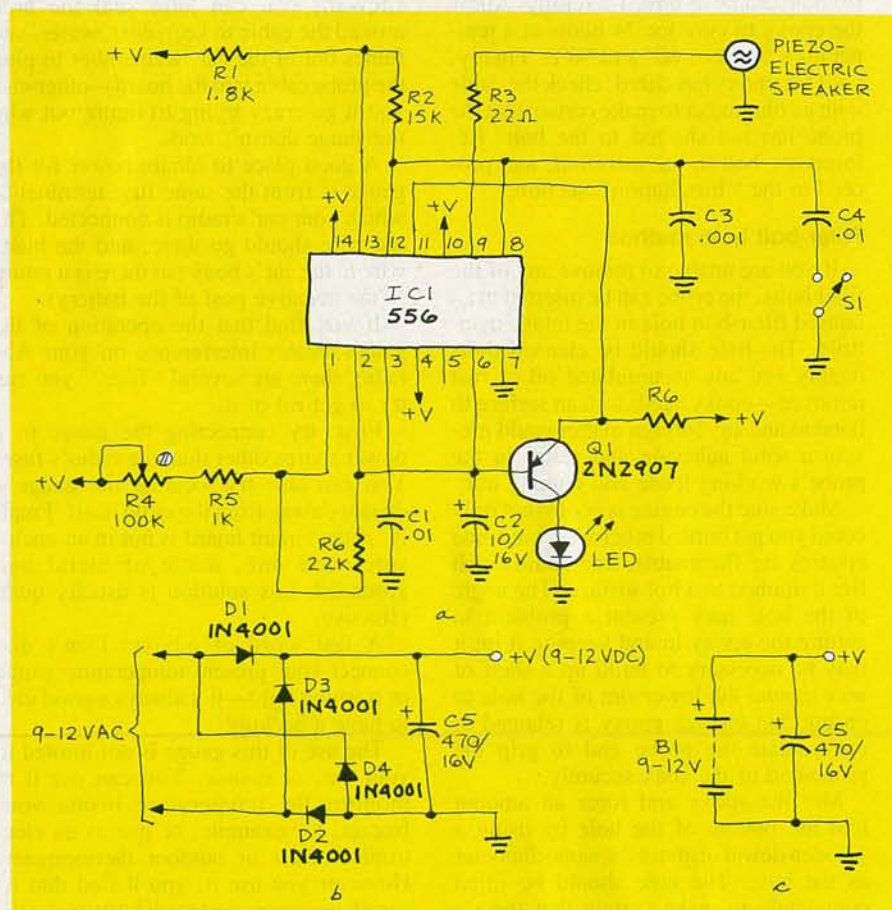

FIG. 1

NEW IDEAS

This column is devoted to new ideas, circuits, device applications, construction techniques, helpful hints, etc.

All published entries, upon publication, will earn \$25. In addition, Panavise will donate their model 333—The Rapid Assembly Circuit Board Holder, having a retail price of \$39.95. It features an eight-position rotating adjustment, indexing at 45-degree increments, and six positive lock positions in the vertical plane, giving you a full ten-inch height adjustment for comfortable working.

I agree to the above terms, and grant **Radio-Electronics** Magazine the right to publish my idea and to subsequently republish my idea in collections or compilations of reprints of similar articles. I declare that the attached idea is my own original material and that its publication does not violate any other copyright. I also declare that this material has not been previously published.

Title of Idea

Signature

Print Name

Date

Street

City

State

Zip

Mail your idea along with this coupon to: **New Ideas Radio-Electronics**, 200 Park Ave. South, New York, NY 10003

No wonder they call it the SUPERFONE!

At Last—a Cordless Phone with TWICE the Range, Sound Fidelity to Rival Phones with Cords, and a Privacy Code System — All This in a Phone Less Than an Inch Thick!



The Super Fone is less than 1" thick. The base unit has a built-in speaker phone, a fully independent intercom and is 110 volt-220 volt switchable.

Until now, cordless phones have given you wonderful convenience. But they've had two problems:

1. The range is limited to 600 to 700 feet.
2. Some of them sound as though you're talking inside a barrel.

As cordless phones have become enormously popular, another problem has arisen: two people, living near each other, can have the same channel. Not only is there line confusion, but someone else can literally make a long distance call on your phone.

No more. Never again.

Range: 1500 Feet OR MORE!

The SuperFone 650 uses state-of-the-art electronics to bring you the ultimate cordless phone. Sound quality is superb — and it stays superb, 1500 feet or more from the base station. That's more than twice the distance of standard cordless phones.

Only SuperFone 650 has a secret code system to prevent interference and false operation of the phone. You choose from 512 possible "code" combinations. Both the base unit and the phone are locked onto that code, which you can change when you want to.

No other phone can interfere. No other unit can share the signal. No one else can hear or speak on your carrier-wave.

Enormous Range

We say the SuperFone 650 has a range of 1500 feet.

Notice we didn't say "up to" or "as far as" 1500 feet. There's no hedging, because this seems to be the minimum, not the maximum range.

Users report 1800 and 2000 feet. That's nearly half a mile. SuperFone 650 is a radiophone, not a toy, and that's why its signal doesn't break up or start hissing or crackling when you get half a block away.

You can tell when you heft it. It's a Little Giant. You can feel the power inside. What a marvel of electronic engineering it is! And it's tough, too. It fits into your shirt pocket, and you can bounce it around all day without damaging it.

Speakerphone, Intercom — Everything!

SuperFone 650 is The Everything Phone. Anything any phone can do, it can do.

First, the base station is a speaker phone. Touch a button and you can have a hands-free conference conversation in the room in which the base station sits.

Next, it's an intercom. You can page the handset from the base unit and have a private conversation. You have a true wireless intercom, not just a signal.

Third, you have a privacy button. Push that button and you'll still be able to hear anything the other party says, but he or she won't be able to hear you until you take the button off "hold."

Fourth, you have an automatic redial. Touch the key and the SuperFone will redial the last complete number.

What else? A security switch which makes it impossible for anyone to call out on the remote phone, without changing the ability to receive calls. A volume control for the speaker on the base unit. A call button to page the base from the cordless phone. THIS PHONE HAS EVERYTHING!

30-Second Installation

Plug your SuperFone 650 into any wall AC outlet. Push its standard modular terminal into the telephone plug. You're in business.

Every component is heavy-duty, from the built-in condenser microphone (with automatic gain control) to the LED indicator lights. This phone is designed for hard use.

The SuperFone 650 is yours for \$249.95 in regular pulse-dial version, \$269.95 in Touch Tone®. If you want the SuperAntenna with it, giving you a range of a mile — or even more — you can have both for \$319.95 (rotary pulse) or \$339.95 (Touch Tone). Or you can get the SuperAntenna alone for \$79.95.

We Absolutely Guarantee!

Use the SuperFone 650 (or any electronic instrument you acquire from us) for up to 30 days. If for any reason you decide not to keep it, return it for a 100% refund.

The SuperFone 650, rotary pulse dial — \$249.95
phone and SuperAntenna — \$319.95.

The SuperFone 650, Touch Tone dial — \$269.95
phone and SuperAntenna — \$339.95.

The SuperAntenna, no phone included — \$79.95.

Multi-Line Adapter, lets you plug several lines into one SuperFone — \$39.95.
Add \$4.50 per total order for shipping.

Rotary Phone or Touch Tone®? SUPERFONE Is Available For Either!

Most cordless phones work on "pulse" (rotary) only. You can't use them for MCI, Sprint, or any of the other systems requiring TouchTone — including talking to a computer.

The SuperFone 650 now has a Touch Tone model, so you can have the unmatched double convenience of a cordless phone and tone dialer!

(Touch Tone model slightly higher.)

TRIPLE THE RANGE OF ANY CORDLESS PHONE!

The SuperAntenna will give your cordless phone, regardless of make or model, three times the range it has now.

If the range is 700 feet, it'll leap to over 2,000. If it's 1500 feet, it could be as far as one mile!

Easy to install. Only \$79.95 complete. Add \$4.50 for shipping.



For instant service, if you have a VISA or MasterCard, call toll-free 24 hours a day, seven days a week:

1-800-824-7888

Ask for Operator 551.
(in California: 1-800-852-7777)

NEW HORIZONS

Dept. RE-8, 1 Penn Plaza, Suite 100
New York, NY 10119

THE DRAWING BOARD

Finishing up about regulators

ROBERT GROSSBLATT

AS YOU'RE PROBABLY AWARE BY NOW, there's a lot more to consider when you're building a power supply than how to get a battery out of a blister pack. Over the last few months we've gone through the design considerations necessary to build a voltage regulator complete with all sorts of bells and whistles. Before we wrap up this project, be aware that we've just barely scratched the surface. There are lots of different sorts of power supplies and we've been looking at only one particular kind. There are design engineers who do nothing else in their professional lives but design power supplies. (That may strike you as being a bit boring but it certainly gives you an idea of the size of the subject.)

Where's the surprise?

Figure 1 is the full schematic of the regulator circuit we've designed. The values for all the components are shown, and if you look closely you'll see that we've added something to the short-circuit protection we discussed last month. We've put in a switch, S1, and broken R_S into two parts. The reason that was done is the surprise I promised.

I told you that there was a way around trying to locate a 0.13 ohm resistor. You probably realized that we would parallel a few resistors to get the value we wanted

and that's exactly what I did. When we close S1 we put the two resistors in parallel and arrive at a value of 0.135 ohms—nothing really surprising about that. Opening S1 puts only one of the resistors in the line and lets us change the trip point of Q2 to two amps. We can now switch-select the short circuit trip-point to be either 2.4 amps or 4.8 amps. The real treat comes when we do the arithmetic necessary to calculate the wattage we need for the resistors.

Let's assume that we have the full value for R_S . We saw that it takes a 0.65 volt drop across the emitter-base junction of Q2 to make it conduct. The short circuit trip-point would be: $I = E/R = .65 / .135 = 4.82$ amps.

That's pretty close to our original target of 5 amps. Now let's calculate the wattage we need for R_S : $P = I^2 R = (4.82)^2 (.135) = 3.14$ watts.

In the interest of safety, and with proper respect for Murphy's law, let's call it 4 watts. This makes R_S a pretty hefty resistor, and probably not too easy

to find. It is easy however, to find a 0.27-ohm, 2-watt resistor, so we'll put two of those in parallel. Since the wattage adds when resistors are in parallel (do you know why?) we have 0.135 ohms at 4 watts when S1 is closed and 0.27 ohms at 2 watts when S1 is open. If you want to verify the calculations for the circuit with S1 open, follow the format I've just used. It's satisfying to see the numbers work out so neatly.

More about component values

If you remember last month's discussion of R_B , you'll recall that we had to do some math to arrive at a value of 2.47 ohms. A look at Fig. 1 will show you that R_B is now specified to be 2 ohms at half a watt. Changing the value to 2 ohms from 2.47 ohms was done in the interests in reality. The only place you'll be likely to find a 2.47-ohm resistor is the same place you'll find a 0.13-ohm resistor—nowhere. You may be considering the idea of using a trimmer potentiometer in place of a fixed resistor. Don't do it—it's a bad idea.

There are two no-no's as far as R_S and R_B are concerned—trimmers are a bad idea, and so are wire-wound resistors. The reasons for avoiding those things have already been discussed and you should realize what they are. Go back through our discussion of regulators so far and figure out the answer. When you get the answer, let me know. The first person to get it right will have the dubious honor of being credited in this column and will receive a prize of four million dollars. The first person to get it wrong will have to come up with the prize money. Only joking, folks—but I will give credit to the first person with the right answer.

The calculation of the wattage I'm going to leave as an exercise for you. To be fair, though, I'll give you the answers. They are shown in Table 1. Make the same assumptions we did last month about the transistor "resistance" and see if you can work out those values.

As you can see, calling for a half watt

TABLE 1

R_S	$R_S + R_B$	I_{R_B} at Q1 turn-on	P_{R_B}
0.135 Ω	2.135 Ω	305 mA	0.185 watts
.27 Ω	2.270 Ω	286 mA	0.163 watts

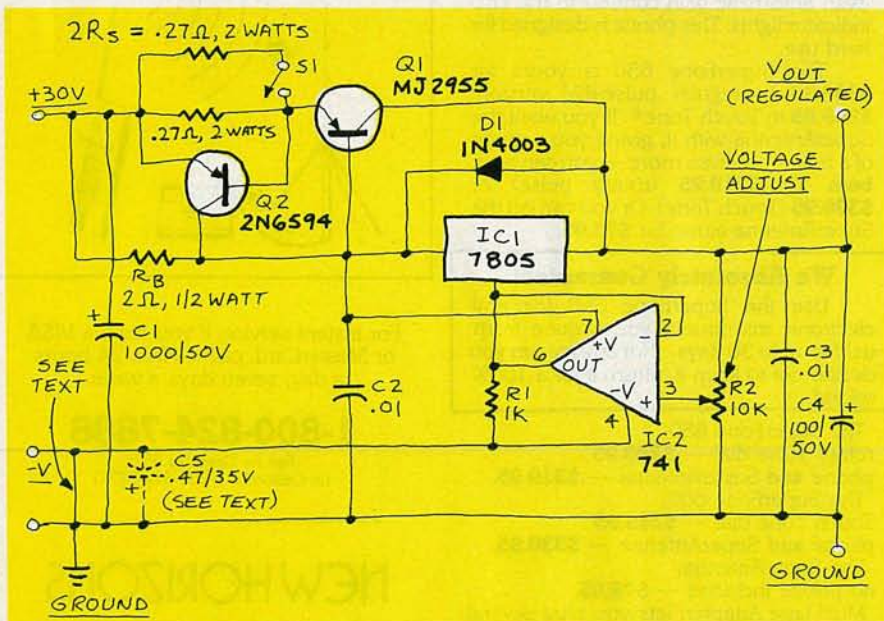

FIG. 1

TO MAGAZINE RETAILERS:

Radio-Electronics Magazine is pleased to announce its "Retail Display Allowance Plan" available to retailers interested in earning a display allowance on **Radio-Electronics Magazine**. To obtain details and a copy of the formal contract, please write to the Marketing Department, Kable News Company, Inc., 777 Third Avenue, New York, New York 10017, our national distributor, who will act as administrator of our plan. Under our Retail Display Allowance Plan, in consideration for fulfilling conditions of the agreement, you will be entitled to receive a display allowance. This plan will become effective for all issues you receive subsequent to written acceptance on our behalf of your application.

TIMEX/SINCLAIR COMPUTER USERS We Have The Books You Need



- ART OF PROGRAMMING THE 1K ZX81.**
How to use the features of the ZX81 in programs that fit into the 1K machine. 96pp. \$5.75 postpaid.
- ART OF PROGRAMMING THE 16K ZX81.**
How to use your 16K RAM pack and ZX printer to the full. 144 pp. \$6.95 postpaid.
- ART OF PROGRAMMING THE ZX SPECTRUM.**
Everything you need to know to put the ZX Spectrum to work for you. 144 pp. \$8 postpaid.

ELECTRONIC TECHNOLOGY TODAY, INC.
P.O. BOX 83
MASSAPEQUA PARK, NY 11762

Name: _____
Address: _____
City: _____ State: _____ Zip: _____
 Number of books ordered

POWER LINE PROBLEMS?



SPIKE-SPIKERS™... The Solution!

Minimize equipment damaging spikes and conducted RF noise to or from sensitive equipment. Transient surge protection plus low pass RFI hash filtering. All units 120V 15A.

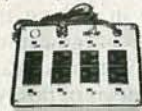

MINI II \$44.95

Wall Mount
3-stage filter
2 sockets

QUAD II \$59.95

Wall mount. Dual 3-stage filter
4 sockets & light

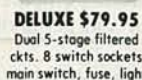

DELUXE \$79.95
Dual 5-stage filtered
ckts. 8 switch sockets
main switch, fuse, light

Kalglo Electronics Co., Inc.
65 84 Ruch Rd., Dept. FE
Bethlehem, PA 18017

Order Factory Direct
215-837-0700

Out of State
800-523-9685

DEALERS INVITED
PA Res. add 6% • COD add \$3.00 + Shipping

CIRCLE 46 ON FREE INFORMATION CARD

for R_B is a bit of overkill, since the calculated value never even reaches one-quarter watt. When we started this exercise in design I told you that one of the cardinal rules of design was always to aim for worst-case operation. By specifying a half-watt resistor we're adding a safety factor of more than two. If you can get your hands on a one-watt resistor of the right value it wouldn't hurt to use that either—you can never have too many watts.

The transistors listed for Q1 and Q2 have the collector-current maximums the circuit calls for. Since they're being used as switches we don't have to worry about any of the parameters we'd have to consider in an analog circuit (frequency compensation, gain, and so on). It's really just a matter of finding some silicon transistors of the right polarity that can handle the calculated current. The MJ2955 can handle 15 amps at its collector, and our circuit only calls for 5 amps—the safety factor again.

As we saw last month, Q2 has to be able to stand the combined short-circuit currents of both the regulator and Q1—that means a collector current of $0.035 + 4.82 = 5.13$ amps. A 2N6594 can handle 12 amps. I called for those transistors because they're easy to find. If you want to substitute other transistors, that's okay—just watch the collector ratings, and make sure you use silicon transistors. If you want to use germanium ones, all the calculations we've done will have to be redone. You tell me why.

Other components

I've called for a 741 as the op-amp to be used for IC2. Actually you can use just about any op-amp there. The 741 seemed to me to be a good choice because it's cheap (always an important design consideration), available, and has internal current-limiting and frequency compensation. If you have some other op-amp lying around, use it. The higher the input impedance the better. Since it's only a buffer, the requirements aren't at all critical.

The last thing to look at is C5. It handles the transients from the negative supply, if you use one, to lower the range of the circuit following the guidelines we developed last month. It goes without saying that if you go this route the connection shown in Fig. 1 between the $-V$ input and ground should be ignored—so I won't say it.

There's nothing sacred about the choice of IC1. If your voltage requirements are going to be consistently higher than five volts use one of the other regulators in the series—the 7812 or 7815 for example. Try giving the the op-amp a bit of gain by putting some resistance on the feedback line from pin 6 to pin 2. The point of these columns is for you to learn—and there are only two ways to do

continued on page 101

CABLE TV Buy Direct & Save

SUPER SPECIALS

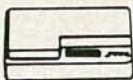

40 CHANNEL
CONVERTER
\$29⁹⁵

Advanced Solid State design and circuitry allows you to receive mid & super band channels. Restores programming to Video Recorders.



36 CHANNEL
REMOTE CONTROL
CABLE CONVERTER
\$69⁹⁵

JERROLD 400
THE ULTIMATE CABLE TV
CONVERTER



60 CHANNEL
INFRARED
REMOTE
CONTROL
\$129⁹⁵

Send \$5 for Complete Catalog

DIRECT VIDEO SALES

P.O. BOX 1329
JEFFERSONVILLE, INDIANA 47130
CALL
1-812-282-4766

CIRCLE 53 ON FREE INFORMATION CARD

FREE ZX81/TS1000 CATALOG



New from Gladstone Electronics! Our ZX81/TS1000 catalog will take you where no one has dared go before! You will view the widest selection of up-to-date software, books and hardware add-ons available to get the most from your personal computer. This exciting new 34 page color catalog lists arcade, fantasy and family games, business and educational programs; books for beginners as well as experienced users; hardware add-ons and other peripherals for use with ZX81/TS1000 Home Computer!

Use the convenient coupon below and send for your FREE catalog TODAY!

New! Write for yours Today!

Complete and mail now for your FREE copy!

For information call (716) 874-5510

GLADSTONE Electronics

Please rush me this exciting new ZX81/TS1000 catalog.

Name _____

Address _____

City _____ State _____ Zip _____

Mail to: 1585 Kenmore Ave., Buffalo, N.Y. 14217
In Canada: 1736 Avenue Rd., Toronto, Ont. M5M 3Y7

HOBBY CORNER

I like birds, but...

EARL "DOC" SAVAGE, K4SDS, HOBBY EDITOR

I AM NOT FASCINATED BY BIRDS, BUT I DO enjoy watching them as they cavort about my yard in the morning and evening. I could identify only a dozen or so species if the need ever arose, so it's apparent that I do not study them beyond casual observation. (But that's enough to have discovered some of their quirks, and to understand that old epithet "bird-brain.")

The reason I'm saying this up front is just to keep you from assuming that I am an enemy of our feathered friends. I do like the little things as long as they stay away from where they don't belong. One of the places they don't belong is in the gutter on my patio roof. When they start carrying nest material in there, they're asking for trouble!

Not wanting to electrocute them or shoot them (and put holes in the patio roof), I despaired of finding a solution other than waving them off from behind the sliding doors. That action, by the way, is effective for about two minutes. Lately, however, they don't care for my gutter. They've learned to steer clear of it because I used my head instead of my arms. In case you have a similar problem, here's one approach you can take to solve it.

Scaring the birds

It's all done with an old doorbell and a timer. The doorbell—minus the bell part—is mounted so that the hammer strikes the gutter (instead of a bell) when it is activated. It both vibrates the gutter and makes a bit of noise—enough of one or the other to send the birds scoting out of there.

At first, I rang the "bell" by pressing a

momentary switch when the need arose. Later, my smarts grew, and I put a small clock-type motor in the control box. On the shaft of the motor is a cam that completes the circuit to the bell for a few seconds every five minutes. The setup is shown in Fig. 1. Now, the "scare 'em away" action takes place automatically. After a while, even birds learn that my gutter is not a pleasant place to build a nest.

Of course, the motor can be switched in and out of the circuit. It is not necessary to let the thing sound off every five minutes forever. In fact, the mechanism isn't put in its automatic mode except early in the spring, and a little bit later whenever a new crop of youngsters starts the nest-building ritual.

The wiring diagram in Fig. 1 can also be used in case you need to keep away other animals (cats or whatever) without harming them.

Computer-tape copying

Both Paul Rittenhouse (PA) and P.J. Donnelly (NY) have written to ask about methods of copying computer programs and data that have been stored on tape. Of course, they can load the data into the computer from one tape and store it on a second one—but that is a time-consuming process. And I don't blame them for trying to find a way around it.

They would like to make copies directly from one tape machine to another but have discovered that this procedure seldom, if ever, produces a usable tape. The reason, of course, is that the signal, which, ideally, is a squarewave, goes through many distorting audio circuits. With two recorders, the signals go

through double the normal number of input and output circuits.

What you need, fellows, is a device that will actually reconstruct the signal from one recorder before it goes into the second one. There are commercial devices available, and there were a couple of circuits in the computer magazines several years ago for such a device. Be forewarned, however, that such devices are computer-specific. You know that a tape from one kind of computer cannot be read by another kind—there is no standardization of signals used. Therefore, the "black box" between recorders must be designed to reconstruct the exact type of signal needed. Perhaps you can modify one of the old circuits to match your computer. Sorry I can't be more specific, but I wish you good luck. Let me know if you are successful—I'll spread the word.

BCD readout

Joe Czerniak up in Michigan would like to put a BCD (Binary Coded Decimal) readout on his digital clock. He figures it will be just as useful with that type of readout and it will be a conversation piece to boot. Well, Joe, the details will vary depending upon the specific clock you have but I can show you enough to get you started.

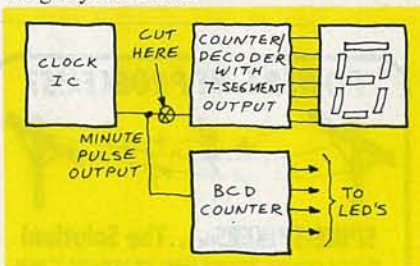

FIG. 2

Clock circuits come in at least three main types. One has the 7-segment readouts driven by multiplexed lines straight from the clock IC. If yours is of this type, the changeover can be quite complex, so I'd advise you to go out and get another one to modify!

A partial diagram of the second type is shown in Fig. 2. In this example, the minute-pulse drives a counter/decoder that has a 7-segment output. Your best bet is to connect a BCD counter to the output of the clock IC in place of the counter/decoder.

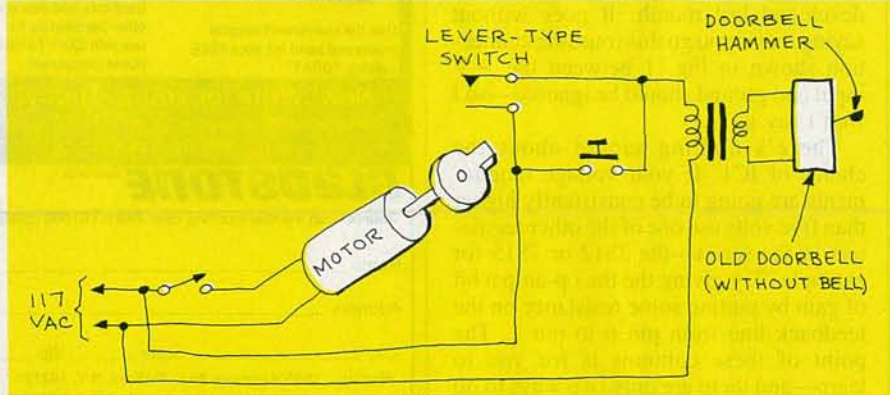

FIG. 1

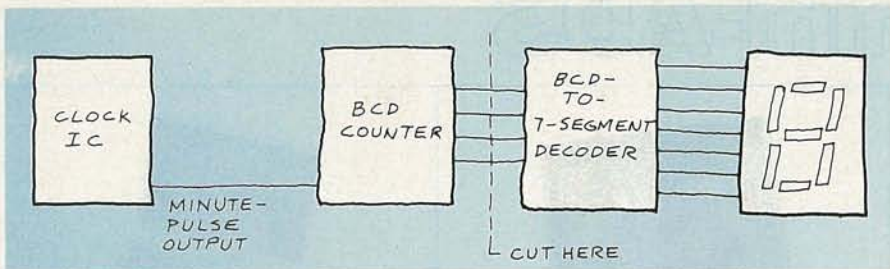

FIG. 3

The BCD counter has "1," "2," "4," and "8" output lines, and all you have to do is to hang an LED on each one. Of course, you will have to replace each of the original digits with a counter (each with four LED's). You could tie the LED's to ± 5 volts or to ground (through appropriate resistors), depending on whether you want to read LED's that are on or off. If you use the latter, you'll really have a conversation piece—even with those visitors who recognize the BCD readouts! The tens-of-hours digit can be replaced with a single LED if the clock is the 12-hour type.

The third type of clock has separate counters and decoders instead of the combination counter/decoders of the previous one. You're in luck if you have this type—it's by far the easiest to modify. Now, all you have to do is disconnect the decoders (cut the lines as is shown in Fig.

3) and hang LED's on the lines of the counters that are already there. Could anything be simpler?

That should be enough guidance, Joe, for you to get the job done. Arrange each set of four LED's in a row or column and have some fun by daring the uninitiated to read the time.

Model speed

Rick McQuillan (Wisconsin) is looking for a way to time the runs of slot cars and pinewood derby cars. Rick, look back at "Hobby Corner" in the January and February 1981, and December 1982 issues of **Radio-Electronics** and you will find some information that should solve your problem. If you don't keep your magazines (and I can't understand why you don't), then you'll have to check with your local library. **R-E**

DRAWING BOARD

continued from page 99

that. Read everything you can get your hands on, and get your hands in everything you read. Components are cheap enough so that blowing a few up is still less expensive than going to school...and more instructive as well.

You should have learned enough to design your own negative supply. Try it and let me see what you come up with. Just be careful. You're playing around with circuitry that can deliver a lot of power. If you heat-sink everything—and you should—you're looking at circuitry that can melt the tip of a screwdriver!

We'll end this discussion of voltage regulators with a problem. I told you that there were other ways to create a negative supply besides using a center-tapped transformer. There are some MSI chips developed specially for this, but that's not what I'm talking about. Anyone who has ever needed a few measly milliamps from a negative supply knows how real the problem is.

If you can dream up a way to create a negative supply—a true negative supply—using only a two-terminal transformer, write and tell me about it. I know what I would do—let's see what you would. **R-E**

TAFT

ELECTRONIC SALES

HAS IT ALL FOR LESS

INTEGRATED CIRCUITS



	1-7	8 UP
•2114-	\$3.45	\$2.75
•2708-	5.65	4.50
•2716-	6.90	5.95
•2732-	7.50	6.50
•4116-	2.50	1.95
•4164-	5.75	5.50
•Z80ACPU-	4.50	3.75

CONNECTORS

•DB25P(RS232)-	\$1.95
•DB25 FEMALE -	2.50
•HOOD -	.89



FLUKE

- 8060A **\$345**
- 8062A **\$275**
- 8022B **\$143**
- 8020B **\$193**
- 8024B **\$247**

BECKMAN

- 300 **\$109**
- 310 **\$129**
- 330 **\$199**

Xcelite®



- TC-100ST XCELITE'S BEST CONTAINS 53 TOOLS **\$329**
- TC-150ST SMALLER VERSION **\$279**



- 99SM ROLL KIT **\$65**

BK PRECISION



- 1476P-10MHZ DUAL TRACE **\$439**
- 1477P-15MHZ DUAL TRACE **\$495**
- 1479BP-30MHZ DUAL TRACE **\$609**
- 1570P-70MHZ QUAD TRACE **\$1079**

PRICES INCLUDE PROBES

OVER 10,000 PARTS IN STOCK.
CALL FOR LOW PRICES.

6.5MHZ OSCILLOSCOPE AT ONLY
\$188.00



- 75MM ROUND SCREEN
- 10mV/DIV. SENSITIVITY
- INTERNAL OR EXTERNAL SYNC
- XY VECTORSCOPE CAPABILITIES
- 8½ LBS. LIGHT & COMPACT
- **ONE YEAR WARRANTY**

20,000 OHM/VDC V-O-M



- DC/AC VOLT TO 1 KV
- FUSE & DIODE PROTECTION
- 17 RANGES ON MIRROR SCALE
- LEVER SELECTOR RANGE SWITCH

\$19.88 ONE-YEAR WARRANTY

VIDEO CONTROL CENTER



\$16.88

REMOTE CONTROL ACCESS OF ALL VIDEO, TV OR CABLE INPUTS TO TV SET.
4 INPUTS TO ONE OUTPUT

46 CHANNEL VCR CONVERTER WITH FINE TUNING



WATCH ONE CHANNEL AND RECORD ANOTHER

VIDEO PROCESSING CENTER

STABILIZER • IMAGE ENHANCER
VIDEO FADER • RF CONVERTER
DISTRIBUTION AMPLIFIER



ONE UNIT DOES IT ALL **\$99.88**

TAFT ELECTRONIC SALES

68 W. 45th Street
N.Y.C., N.Y. 10036

CALL
212-575-
8632

• MASTER CHARGE • VISA
• MONEY ORDER • CHECK
25% DEPOSIT ON C.O.D.'s

ADD FOR SHIPPING
UP TO \$300.00 - \$5.50
OVER \$300.00 - \$8.00
N.Y.S. ADD SALES TAX

AUGUST 1983

101

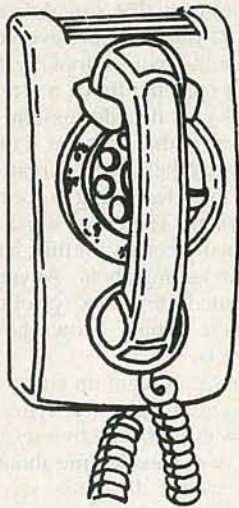

CALL NOW AND RESERVE YOUR SPACE

- 6 x rate \$550 per each insertion.
- Reaches 220,500 readers.
- Fast reader service cycle.
- Short lead time for the placement of ads.
- We typeset and layout the ad at no additional charge.

Call 212-777-6400 to reserve space. Ask for Arline Fishman. Limited number of pages available. Mail materials to: mini-ADS, RADIO-ELECTRONICS, 200 Park Ave. South, New York, NY 10003.

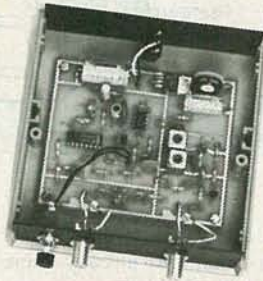

CABLE TV DESCRAMBLER KIT \$39.95
Computerized addressable gated sync type. We also have complete line of Jerrold and Oak cable TV converters and descramblers. Such as, Jerrold gated sync (SB-3), Oak sinewave (N12), and Jerrold 61 channel remote control converter descrambler (DRX-DIC-105). 90 day warranty. **SEND \$2.00** for "INFORMATIVE CATALOG" for prices and availability to: **J & W ELECTRONICS, INC., P.O. Box 61-X, Cumberland, RI 02864.**
CIRCLE 63 ON FREE INFORMATION CARD



NEW DTMF Receiver Kit turns phones into control devices. With Teltone's TRK-956 kit, you get all the parts necessary to breadboard a central office quality DTMF detection system for only **\$22.75**. That's the lowest installed cost for a DTMF system. All you provide is 5V dc. For decoding DTMF signals from telephone lines, radios, and tape players, use the TRK-956. To order call: **Teltone, (800) 227-3800 ext. 1130. (In CA, (800) 792-0990 ext. 1130).**
CIRCLE 65 ON FREE INFORMATION CARD

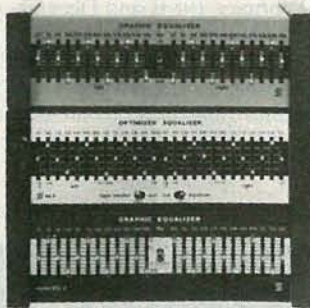

Equalizers ... Equalizers ... Equalizers • EQ-2 (top) 12 bands/channel general purpose equalizer—see R-E 5-6/78 **\$89** • Optimized EQ: 10 midrange 1/2 octave, 3 other bands. See C&E 12/81, 1/83 **\$100** • EQ-3, 24 bands mono **\$110** stereo **\$200**. Free shipping w/check. Visa, M/C. Catalog. **Symmetric Sound Systems 856L, Lynn Rose Ct., Santa Rosa, CA 95404, (707) 546-3895.**
CIRCLE 72 ON FREE INFORMATION CARD



MODERN ELECTRICS. Miniature souvenir of the first publication ever produced by Gernsback Publications. This issue appeared in April 1908—just 75 years ago. You can own your own reprint of this unique first edition for just **\$2.50** plus 75c P&H. It's available from **R-E BOOKSTORE, Radio-Electronics, 200 Park Avenue South, New York, NY 10003**



NEW PRODUCT—Computerized Addressable Cable TV Descrambler in/out Channel 3. Restores picture to normal sync. Passes undistorted audio signal. Gated Pulse-Suppressed Sync Kits **\$59.95** Wired and tested **\$119.95**. Sinewave Kits **\$69.95** Wired and tested **\$129.95**. Also carry a full line of UHF Descramblers. Money orders, check, COD only. Add 5% shipping. Quantity discount. Send \$2.00 for complete catalog on converters and descramblers. **MEAN ELECTRONICS, PO Box 347, Boston, MA 02188 (617) 337-7303.**
CIRCLE 65 ON FREE INFORMATION CARD



CLOSE OUT - BLOW OUT - LIQUIDATION SALE - AMATEUR MICROWAVE RECEIVER - REGULARLY \$99.50. NOW LIQUIDATING AT ONLY \$59.95 EACH! (Dealer "eight-pack" for just \$399.00) Complete system includes dish, probe/downconverter, co-ax cables, power supply, hardware and instructions. Top quality units with genuine #2137 transistors for hi-gain, lo-noise. **ORDER TODAY!** Supply limited. Money order, VISA or Mastercard only. (No C.O.D. at this price.) **T.V. PRODUCTS CO., 635 Park Ave., Dept. 222, Idaho Falls, Idaho 83402. DESCRAMBLERS??** We stock all types. Send \$3.00 for catalog!



ELECTRO IMPORTING CO. CATALOG. This reprint of the historic 176-page catalog No. 20 gives you an accurate look at the state of electronics in 1918. Contains everything from a Zinc Spark Gap to a 1000-Mile Receiving Outfit. You can get your own copy of this modern antique, profusely illustrated, for only \$4.95 plus \$1.00 P&H. Order yours from **R-E BOOKSTORE, Radio-Electronics, 200 Park Avenue South, New York, NY 10003.**

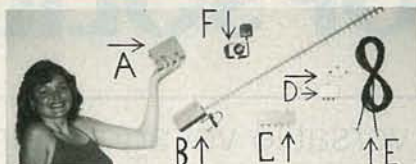

DYNASTY ELECTRONICS NOW PRESENTS THE WORLD'S SMALLEST AND MOST ADVANCED MICROWAVE TELEVISION ANTENNA, FEATURING - 3 stage pre-amp, drift-free circuitry; low profile weather-proof housing. (A) MICRO-MINI: 3 1/2" x 5 1/4" - 49db gain—\$149, (B) YAGI TRI-STAR - 62db gain, 80 mi. range—\$169, (C) VCR CONTROL CENTER—\$45, (D) 2 SET HOOK-UP—\$35, (E) RG-59 Coaxial cable, specify length; per/foot 10¢ (F) TUNER—included with (A) & (B); separate—\$45. Dealers wanted. Catalogue \$2.00. Send money order or cashiers check to: **DYNASTY ELECTRONICS, 1253 Garnet Ave., Suite D, San Diego, CA. 92109. COD. ORDERS, call 1-916-273-7502.**

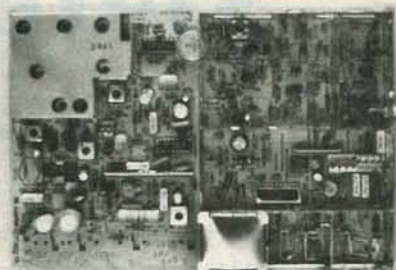

TELEVISION MODULE includes VHF, UHF, and CABLE-TV TUNERS, IF AMPLIFIER, VIDEO DETECTOR, SOUND DETECTOR and AMPLIFIER, and SYNC PROCESSOR: **\$85.00.** TELEVISION SIGNAL PROCESSING MANUAL explores standard and non-standard television: **\$15.95.** Add 5% handling and shipping. Catalog \$2.00. Visa and MC accepted. ORDER DESK (415) 439-7470. **ABEX, P.O. BOX 26601-RZ, SAN FRANCISCO, CA 94126.**

CIRCLE 62 ON FREE INFORMATION CARD

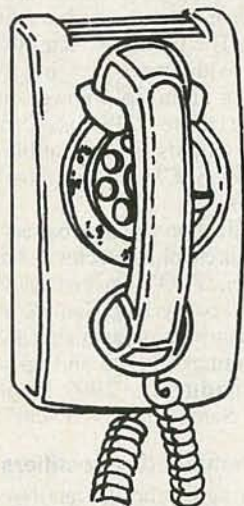

**CALL NOW
AND
RESERVE
YOUR SPACE**

- 6 x rate \$550 per each insertion.
- Reaches 220,500 readers.
- Fast reader service cycle.
- Short lead time for the placement of ads.
- We typeset and layout the ad at no additional charge.

Call **212-777-6400** to reserve space. Ask for Arline Fishman. Limited number of pages available. Mail materials to: **mini-ADS, RADIO-ELECTRONICS, 200 Park Ave. South, New York, NY 10003.**



Introducing an **ULTRASONIC ECHO RANGING KIT** with up to 20 feet and greater ranging capabilities. May be interfaced to your microcomputer or used alone with analog output and 4 digit LCD display. Applications in Robotics, Alarms, Positioning, Level control and more. Complete kit #ERS400KD @ **\$139.50.** Less enclosure and LCD display #ERS400 @ **\$89.50.** Money orders, checks accepted. COD add 10%. **TRABAND ELECTRONICS, INC., P.O. Box 166, Clifton Heights, PA 19018 (215) 623-2700.**
CIRCLE 64 ON FREE INFORMATION CARD

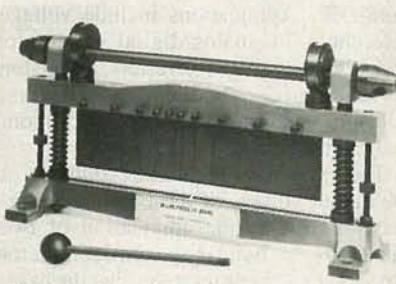

Make your own prototypes! This 14" In-Line Press Brake is constructed of high-grade ductile iron castings and steel parts. Standard equipment includes male dies for straight or box bends from 1/2" to 14" plus a FREE urethane forming pad. Write or call for literature and prices on our SPECIAL Shear-Notcher-Brake package. **PACIFIC ONE CORP., Suite K217, 513 Superior Ave., Newport Beach, CA. 92663; (714) 645-5962.**
CIRCLE 58 ON FREE INFORMATION CARD

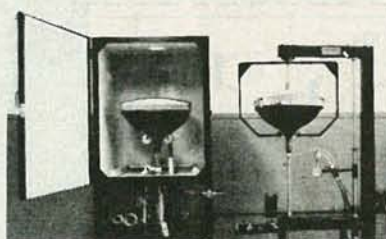

ONE MAN CRT FACTORY, easy operation. Process new or rebuild old CRT's for tv's, bus. machines, monitors, scopes, etc. Color, b&w, 20mm, foreign or domestic. 3x6 ft. space required. Profits??? Average CRT rebuilding cost — \$5. Sell for \$100 = \$95 profit; x 5 CRT's = \$475 daily; x 5 days = \$2375 weekly profit. Higher profits outside U.S.A. Investigate this opportunity today. We service the entire world. Write or call: **CRT Factory, 1909 Louise St., Crystal Lake, IL. 60014, (815) 459-0666.**
CIRCLE 61 ON FREE INFORMATION CARD



PAY-TV?
CONVERTERS
DESCRAMBLERS-MICROWAVE-Not C and D grade. Only grade A new, genuine Oak, Jerrold, Zenith, Hamlin, Pico, Bogner, Pioneer! Name it! Sine-wave, gated-sync, vari-sync, in-band, out-band. We sell 'em all! No order too big or small. Dealers—we can beat any price. Send \$3.00 for catalog to: **TV PRODUCTS CO., 635 Park Avenue, Suite 222, Idaho Falls, ID 83402.**

STATE OF SOLID STATE

Two versatile voltage references

ROBERT F. SCOTT SEMICONDUCTOR EDITOR

VOLTAGE REFERENCES ARE USED TO PROVIDE a constant output-voltage regardless of changes in input voltage, load current, or temperature. The REF-01 and REF-02 are monolithic voltage-reference IC's from PMI (Precision Monolithics Inc., 1500 Space Park Drive, Santa Clara, CA 95050). The REF-01 develops +10 volts and the REF-02 +5 volts. Both devices feature excellent temperature stability, low noise, low power consumption, and high load-driving capability. They are available in three package-types: TO-99, 8-pin hermetic DIP, and 8-pin epoxy mini-DIP. Applications include voltage references in analog/digital converters and digital/analog converters, precision current-sources, use in panel meters, cold-junction thermistor compensation, and calibration standards.

The excellent temperature-stability of the output voltage of these voltage references is due to the application of two theorems in band-gap semiconductor physics. One theorem states that the base-emitter voltage (V_{BE}) of a transistor is dependent on the collector-current and has a negative temperature coefficient. The second theorem states that the difference in the V_{BE} of two transistors operating with different currents has a positive temperature coefficient.

When the difference in the two V_{BE} 's (ΔV_{BE}) is amplified and added to the V_{BE} of one of the transistors, a voltage reference with a zero temperature-coefficient results if the sum of the two terms equals

1.23 volts—the band-gap voltage of a silicon junction at 0°K or -273°C. That 1.23 volts is amplified to produce stable outputs of +5.000 volts in the REF-02 and +10.000 volts in the REF-01.

In addition to the stable +5-volt reference output, the REF-02 provides an additional output voltage that is linearly proportional to the ambient temperature. That voltage, V_{TEMP} , is taken from the junction of R1 and R2. Figure 1 is a simplified schematic of the REF-02. The REF-01 is similar but it does not bring V_{TEMP} out to a terminal pin.

The REF-02 generates a ΔV_{BE} of 72 mV at 25°C. That's done by making the current density (current/area) through Q2 sixteen times greater than that through Q1; while transistor Q2 has four times the emitter current of Q1, Q1 has four times as much emitter area as Q2. A voltage equal to ΔV_{BE} (72 mV) is developed across R1 and is amplified 8.75 times and then added to the V_{BE} of Q2 to become V_Z —1.23 volts with a zero temperature-coefficient. As a proof: V_{BE} of a silicon transistor is 0.6 volts (600 mV) at 20°C and $8.75 \times 73 \text{ mV} = 630 \text{ mV}$, and $600 + 630 = 1230 \text{ mV}$ or 1.23 volts.

The $-2.1 \text{ mV}/^\circ\text{C}$ temperature coefficient (TCV_{BE}) is canceled by the $+2.1 \text{ mV}/^\circ\text{C}$ (TCV_{TEMP}) to produce a V_Z of 1.23 volts. That value is amplified by 4.06 to produce a V_{REF} of 5 volts in the REF-02, or amplified by 8.13 to produce a V_{REF} of 10 volts in the REF-01.

In the next column we'll look at how

we can use either voltage-reference IC, along with a handful of other parts, to build an electronic thermometer. Direct temperature readings (in either °F or °C) can be displayed on a voltmeter (digital if desired).

Programmable quad comparator

The new National Semiconductor LP165/LP365 quad comparators feature low-power operation ($10 \mu\text{W}$ per comparator) over a wide range of supply voltages. The four comparators on each chip can be programmed simultaneously for various supply currents, input currents, response times, and output-current drives. The family operates from a single supply with outputs ranging from 4 to 36 volts, or from split-power supplies delivering ± 2 to ± 18 volts DC. The comparator outputs are compatible with DTL, TTL, MOS, CMOS, and most other logic families.

Applications include battery power circuits, threshold detectors, zero-crossing detectors, VCO's, multivibrators, and A/D and V/F converters. Sample and production quantities are available at \$1.75 each in quantities of 100 and up.—**National Semiconductor**, 2900 Semiconductor Drive, Santa Clara, CA 95051.

High-temperature rectifiers

Four new Schottky rectifiers that have a 175°C junction capability have been added to Motorola's product line. The higher-temperature 65- and 85-ampere, 35- and 45-volt diodes offer a greater temperature-margin in switching-power-supply design than previous 150°C devices.

The devices are the MBR6535/45 and MBR8035/45. The first two digits in the type number indicate the current rating in amperes when T_C is 120°C at the rated V_R (blocking voltage). The second pair of digits shows the voltage rating. For example, the MBR6535 is a 65-amp, 35-volt device. Similarly, the MBR8045 is a 45-volt device rated at 80 amps. These devices are ideally suited for use as rectifiers in low-voltage, high-frequency inverters and for service as free-wheeling diodes and polarity-protection diodes. Prices in quantities of 100 to 499 range from \$3.55 to \$4.45.—**Motorola Semiconductor Products**, Attention: Cliff Peterson, PO Box 20912, Phoenix, AZ 85036.

R-E

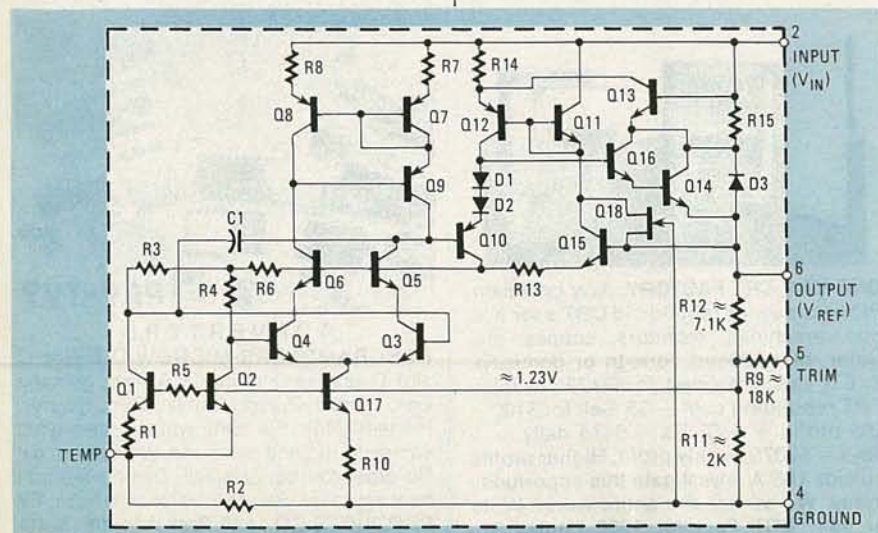

FIG. 1

Radio-Electronics
Special Projects
 The magazine for people who build electronic projects

#7
 \$2.25
 SUMMER
 1983

48764

SYNDLE
 The Electronic Candle
 that flickers like
 a Wax Taper

MAKE PRO CABINETS
 for Home-Brew Projects

Build it for FUN

- 3-Band Shortwave Converter
- Electronic Slot Machine
- Preamplifier for moving coil
Phono Cartridge
- Soundbox-80 for Computer
Game Sounds
- Prototyping Power Supply

Test Gear Projects

- Ribbon-Cable Tester
- Meg-O-Dapter for DVM
- Mini-Audio Generator
- Scope Calibrator
- Single Sweeper One Blanker

PLUS....
JBL Sound System
 for the musician!

INTRODUCING OUR NEW SUBSCRIPTION OFFER!

Become a Charter Member Subscriber!

Get every issue!

SUBSCRIBE TODAY!

Use the order form below.

Subscribe Today!

■ IF YOU'RE THE KIND OF READER that doesn't want to wait, you can order your next copy of **Special Projects** now. **Special Projects** is crammed full of electronic projects that you won't be able to wait to build for yourself. You can expect top-notch digital projects, fun-to-play electronic games, valuable add-on computer projects, BCB and shortwave receivers, photographic/darkroom gadgets, devices to improve your car's performance, test equipment ideas, and more in every jam-packed issue of **Special Projects**.

■ TO HELP YOU TO BE SURE that you don't miss any future issues of **Special Projects**—SUBSCRIPTIONS ARE NOW AVAILABLE!

■ YOU CAN HAVE THE NEXT FOUR ISSUES of **Special Projects** delivered directly to your home for only \$9.00. We pay the postage. If you want the next eight issues, you can even save a dollar off the newsstand price. Get eight issues for \$17.00.

■ EVERY ISSUE OF SPECIAL PROJECTS will continue to contain a variety of construction articles to suit every taste. In addition, feature articles on electronics fundamentals, test equipment and tools will round out each issue. Of course, we will continue to provide new product and literature listings to keep you up to date on the latest developments in electronic technology.

■ GET IN ON THE ACTION! Order your next issue of **Special Projects** today. Use the convenient order coupon below.

Special Projects SUBSCRIPTION

Detach and mail today to:
 SPECIAL PROJECTS
 SUBSCRIPTION DEPT.
 200 PARK AVE. SOUTH
 NEW YORK, N.Y. 10003

CASH WITH ORDER ONLY RE8-83
 Allow 6-8 weeks for the first issue to arrive.

Please print

(Name)

(Street Address)

(City)

(State)

(Zip)

DSP

I want to be sure I don't miss any issues. Send me the next four issues of **Special Projects** for \$9.00: starting with #8. Postage is free in U.S. For Canada add \$3.00. Foreign add \$7.00.

I want to be sure I don't miss any issues and want to save \$1.00 too. Send me the next eight issues of **Special Projects** for \$17.00: Starting with #8. Postage is free in U.S. For Canada add \$6.00. Foreign add \$14.00.

Send me _____ copies of **Special Projects** #8 at \$2.25 plus \$1.00 postage and handling for US, Canada and Mexico. U.S. funds only. All other countries add \$2.00.

AUGUST 1983

SERVICE CLINIC

Bits and pieces

JACK DARR, SERVICE EDITOR

EVERY NOW AND THEN I RUN INTO A situation that I think is interesting, but that is too short for a full column. The solution, of course, is to string several of those together into sort of a bits-and-pieces column. And, as you can see from the title of this column, that's just what we'll do this month.

The first involves a GE 19QB, with no video—just a smooth, dim raster. The video signal could be traced as far as the last stage, and the video amplifiers all tested out as good. The trouble was finally found to be a shorted transistor in the vertical circuit. Stop and think about that for a moment. What transistor in the vertical circuits could affect the video? Remember that the vertical circuit was working; the raster was full. There is only one possibility; the vertical-blanking stage! That transistor feeds pulses from the vertical output into the last video stage. When it shorts, it upsets the bias on the video output and away goes your signal!

Audio trouble

Here's one involving the audio tube in an old set. There was no plate voltage at all; no signal either, of course. The dropping resistor checked out OK, as did the B+. The following test pinpointed the problem: After turning the set off, we hooked a DC voltmeter to the plate of the audio tube. When the set was turned on, the voltage at first came up almost to B+, then dropped off to zero as the tube warmed up.

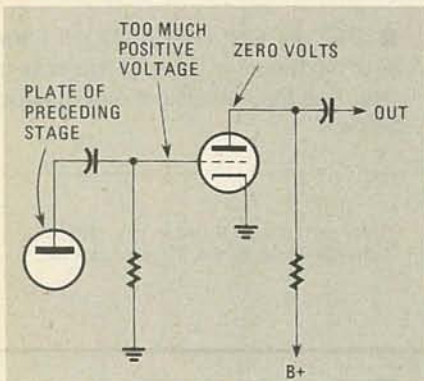

FIG. 1

Have you figured this one out yet? What's happening is that the tube is being biased on so hard that the excess plate current drops the plate voltage to zero.

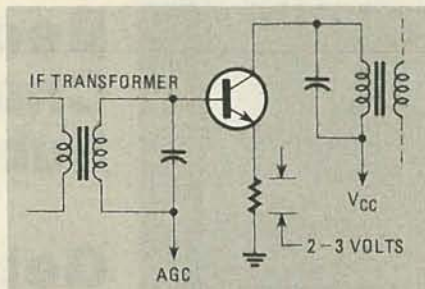

FIG. 2

The cause is usually some leakage in the coupling capacitor between the plate of the preceding stage and the grid (see Fig. 1). That leakage puts too much positive voltage on grid. If that leakage is quite small, the plate voltage may not go all the way to zero but there still will be noticeable distortion.

Troubleshooting the IF

Now to change the topic completely, symptoms of trouble in the IF stage—smooth raster, no picture—are easy to spot; the problems arise when you try to troubleshoot that section. You can't read the collector or base voltages; if you use a voltmeter it will kill the high-frequency signal. Instead, read the emitter voltages. You can read those without upsetting anything because there is no signal on the emitter.

In practically all of those circuits there is a small resistor between the emitter and ground (see Fig. 2). The voltage drop across that resistor is a measure of the collector current. Normally that drop will be small, in the neighborhood of about 2-3 volts, so a digital voltmeter will help. If you find a stage with no emitter voltage, that transistor is open. If there is too much emitter voltage, the transistor is probably leaky. In some cases, you'll just see a very weak signal. What's happening there is that the device is open, but the small capacitances between the elements of the device are coupling the signal through.

Coincidences

Coincidences can sometimes drive you crazy. Consider the problem we had with an RCA CTC-96A. The symptom was a thin horizontal line, which indicated a vertical-sweep problem. The voltages on output stage were all way off, naturally.

When the transistors were checked,

however, they all proved to be good. We finally found that R117 was open. When it was replaced the sweep returned, but there was overscanning with glitches at the top. It turned out that R116 was also open. When it was replaced everything worked fine.

Whatever the odds against those two 220K resistors going out at the same time are, it did happen, so never overlook anything; incidentally, those resistors looked brand new—there was no discoloration—which just shows how undependable those kinds of indications are; the only way to be sure, of course, is to use an ohmmeter.

Before we leave this topic, let's look at an interesting aside. In-circuit measurement of resistances can produce some very odd results. That's because there can be several parallel paths in the circuit. We ran into a good example of that some time back. The set in question had very poor horizontal sync. The DC voltages around the sync-separator all seemed pretty close to what they should be. Everything fed through some resistors. Those resistors all seemed OK when checked in circuit, but when the end of one of them, a 1K unit, was lifted, the device proved to be open. Replacing it quickly cleared up the problem.

Catastrophic failures

If you ever run into a situation where several small-signal transistors have blown, look out! Always check the regulated DC power-supplies before turning the set back on. In a Quasar TS929, the 20-volt regulator shorted out; that put over +30 volts on the +20-volt line. Obviously that's no good.

In troubleshooting such a situation a Variac is essential. Plug the set into the Variac, read the regulated B+ voltage, then bring the line voltage up until the meter shows the rated DC voltage; +20 volts in the case above. Now see if the set works. If it does, and you are applying somewhat less than 117-volts AC to the set (say about 75-volts AC), that is proof positive that the voltage regulator is not doing its job.

There you have it. If any of these bits and pieces saves someone out there even just a small bit of time or aggravation, then this column will have fulfilled its purpose.

R-E

MARKET CENTER

FOR SALE

CABLE TV products: Jerrold, Hamlin, and Oak converters. Send \$3.00 for catalog. **ADDITIONAL OUTLET CORP.**, 231 E. Commercial Blvd., Ft. Lauderdale, FL 33334.

CABLE TV SECRETS—the outlaw publication the cable companies tried to ban. HBO, Movie Channel, Showtime, descramblers, converters, etc. Suppliers list included. Send \$8.95 to **CABLE FACTS**, Box 711-R Pataskala, OH 43062.

PCB 15 cents sq-in. Free drilling. Quantity discount. **INTERNATIONAL ENTERPRISE**, 6452 Hazel Circle, Simi Valley, CA 93063.

RESISTORS 1/4 & 1/2W 5% C.F. 3 cents. 1% M.F. 0811 values. **No minimums.** Volume discounts. Write **JR INDUSTRIES**, 5834-B Swancreek, Toledo, OH 43614.

COLOR computer VIC-20 programs hardware Rtty code EPROM Programmer RS-232. **FRANK LYMAN**, Box 3091, Nashua, NH 03061.

SCANNER/monitor accessories—kits and factory assembled. Free catalog. **CAPRI ELECTRONICS**, Route 1R, Canon, GA 30520.

FAST, dependable mail-order! Prime semiconductors, parts, supplies. **Free 55 page catalog.** **THE PARTSTORE**, Dept. 165, 999 44th St., Marion, IA 52302 (319) 373-1803.

Full Size Keyboard Conversion

10 3/4 x 7 1/4 x 2 1/8

For Your ZX81/TS1000

SUN KD-81

\$69⁹⁵

Easy To Install
No Soldering—No Modifications
41 Keys with Full Size Space Bar • Allows Touch Typing
Same Key Layouts as Sinclair • Two Color Keypops
Keyboard Case Holds Both Keyboard and Computer
Commands and Graphics Spelled Out on Keypops
Rear Cutout for Any RAM or Expansion Modules

16K Piggyback RAM Module ... P/N MX-16 \$49.95

SUNTRONICS CO., INC.

In Calif Call 213-644-1149

Outside Calif Call 1-800-421-5775

Or send Check or M.O. to:

P.O. Box 1957 Hawthorne CA 90250

California residents add 6 1/2% sales tax.

Add \$4.00 ship/handling. VISA/Mastercard include expiration date.



THE Intelligence Library. Restricted technical secrets—books on **electronic surveillance, lock-picking, demolitions, investigation, etc.** Free brochures: **MENTOR**, Dept. Z, 135-53 No. Blvd., Flushing, NY 11354.

SURVEILLANCE device schematics, books on **electronic surveillance methods & equipment, locksmithing, covert technologies, etc.** Catalog, \$1.00. **MENTOR**, Dept. Z, 135-53 N. Blvd., Flushing, NY 11354.

UNUSUAL UHF subscription TV kits. Also microwave downconverters. Catalog 50 cents. **TROJAN**, 2920 Shelby, Indianapolis, IN 46203.

.125 aluminum—make your own chassis! Cut to size, squares, rectangles only. 6 cents sq. in., \$10.00 minimum, \$2.00 handling. Shipped UPS collect. Send dimension(s) of piece(s) to: **O'DAY**, PO Box 248, Lansing, IL 60438.

RELIABLE MICROWAVE TV ANTENNAS

2.1 to 2.6 GHz

Frequency Range

34db System Gain (or Greater)

Complete System (pictured) \$119.95

Down Converter Probe Style

(Assembled & Tested) \$49.95

Power Supply (12V to 16V DC+)

(Assembled & Tested) \$39.95

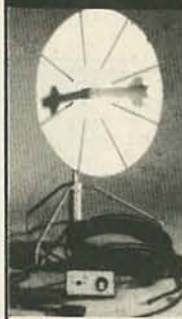

PETERSON ELECTRONICS

4558 Auburn Blvd.
Sacramento, CA 95841
(916) 486-9071

SPECIAL QUANTITY PRICING

Dealers Wanted - COD'S

1 YEAR WARRANTY PARTS & LABOR



ELECTRONICS catalog: Scanners, CB, video. All kinds of electronic goodies. Send \$1.00 refundable. **CLEM ELECTRONICS**, 1520 N. Pacific, Fresno, CA 93728.

TUBES—all types, discount prices. Many oldies and hard-to-find types. SASE for list. **ANTIQUE RADIO & TUBE CO.**, Dept. 701, 1725 W. University, Tempe, AZ 85281.

PRINTED-circuit boards: single side, prototype, and quantity, quick delivery. Send positive, free quotes. **FABTRON**, Box 925, Dept. C, Columbia, TN 38401 (615) 381-1143.

RADIO West—still the best for SW/MW DX receivers and receiver modifications! Catalog 50 cents. **RADIO WEST**, 3417 Purer Road, Dept RE, Escondido, CA 92025 (619) 741-2891.

QUALITY MICROWAVE TV SYSTEMS

Complete Systems From \$69⁹⁵

1.9 to 2.5 GHz Antennas

Galaxy Electronics

6007 N. 61st Ave. Glendale, Az. 85301

1-602-247-1151 1-800-247-1151

COD's / Dealers Wanted



107

To run your own classified ad, put one word on each of the lines below and send this form along with your check for \$1.90 per word (minimum 15 words) to:
Radio-Electronics, 200 Park Avenue South, N.Y., N.Y. 10003

ORDER FORM

PLEASE INDICATE in which category of classified advertising you wish your ad to appear. For special headings, there is a surcharge of \$15.00.

() Plans/Kits () Business Opportunities () For Sale
() Education/Instruction () Wanted () Satellite Television

Special Category: \$15.00

PLEASE PRINT EACH WORD SEPARATELY, IN BLOCK LETTERS.)

1	2	3	4	5
6	7	8	9	10
11	12	13	14	15
16	17	18	19	20
21	22	23	24	25
26	27	28	29	30
31	32	33	34	35

PLEASE INCLUDE FOR OUR FILES YOUR PERMANENT ADDRESS AND PHONE NUMBER.

CLASSIFIED COMMERCIAL RATE for firms or individuals offering commercial products or services). \$1.90 per word prepaid (no charge for zip code)...**MINIMUM 15 WORDS.** 5% discount for 6 issues, 10% for 12 issues within one year, if prepaid.

NON-COMMERCIAL RATE (for individuals who want to buy or sell a personal item) \$1.25 per word prepaid...no minimum.

ONLY FIRST WORD AND NAME set in bold caps. Additional bold face (not available as all caps) at 15c per word. All copy subject to publisher's approval. **ADVERTISEMENTS USING P.O. BOX ADDRESS WILL NOT BE ACCEPTED UNTIL ADVERTISER SUPPLIES PUBLISHER WITH PERMANENT ADDRESS AND PHONE NUMBER.** Copy to be in our hands on the 20th of the third month preceding the date of the issue (i.e., August issue closes May 20th). When normal closing date falls on Saturday, Sunday, or a holiday, issue closes on preceding working day.

FOR SALE

DESCRAMBLERS! Largest supply USA. Catalog \$3.00. **TV PRODUCTS CO.**, 635 Park Ave., Idaho Falls, ID 83402.

FREE speaker catalog! Woofers, mids, tweeters, hardware, crossovers, grille cloth, kits, information, much more. **Discount prices.** **UNIVERSAL SOUND**, Dept. RE, PO Box 36052, Sarasota, FL 33583 (813) 953-5363.

FREE catalog of surplus electronics parts and hardware. **UNIVERSAL SOUND**, Dept. RES, PO Box 36052, Sarasota, FL 33583 (813) 953-5363.

ANTIQU radio information, amazing source. We have literature and prices. \$2.00 (refundable) and **SASE.** **ANTRONICS**, Box 1341, Bettendorf, IA 52722.

RECORDS—tapes! Discounts to 73%; all labels; no purchase obligations; newsletter; discount dividend certificates; 100% guarantees. Free details. **DISCOUNT MUSIC CLUB**, 650 Main Street, PO Box 2000, Dept. 30883, New Rochelle, NY 10801.

COMPUTER cables, RS232, VIC 20, and C64 cables, breakout boxes, and switch boxes. **More!** For free catalog, write **COMPUCOMM**, Box 211, South Sioux City, NE 68776.

ACCESSORIES: Audio—Video—Computer. Discount prices! Factory fresh. Catalog \$1.00 (refundable). **E&D SPECIALTIES**, (RE1), PO Box 420, Gurnee, IL 60031.

THE BEST PLACE TO BUY, SELL or TRADE NEW and USED EQUIPMENT

NUTS & VOLTS MAGAZINE
BOX 1111-E • PLACENTIA, CA 92670
(714) 632-7721

Join Thousands of Readers Nationwide Every Month

ONE YEAR U.S. SUBSCRIPTIONS
\$7.00 - 3rd Class • \$12.50 - 1st Class

\$25.00 - Lifetime - 3rd Class

NUTS & VOLTS

HIGH GEAR COMPUTERS SOFTWARE • OPTICS SCANNERS • OPTICS TEST EQUIPMENT MICRO WAVE SATELLITE AUDIO VISUAL NEW PRODUCTS COMPONENTS • KITS ANTIQUE ELECT. PUBLICATIONS PLANS • SERVICES

FREE money-saving bulletin on popular brand name programs and books for your small computer. **SUPERIOR**, Dept. RE, 8030 Westchester Road, Westchester, OH 45069.

LATEST bug-detection equipment for home or office. Literature, \$1.00. **CLIFTON**, Box 220-X, Miami, FL 33168.

WALKMAN type AM/FM stereo cassette player with stereo earphones and vinyl carrying case. Only \$49.95 plus \$2.00 S&H. MasterCard/Visa accepted. Indicate Interbank number, account number, expiration date. Missouri residents add \$2.81 tax. **SCOTT ENTERPRISES**, PO Box 778, Florissant, MO 63033.

FREE VIC-20 software and hardware catalog. Fast service. **LIGHTHOUSE SALES**, Dept. 1, PO Box 68, Trenton, MI 48183.

DIGITIZER/Graphics Tablet for VIC20 or 64 with 16" x 20" drawing board and two function keys. Demo programs included. \$39.95 plus \$3.50 shipping from **PERSIMMON PERIPHERALS**, Box 2306A-RE, Clayton, GA 30525.

PAL to NTSC conversions. High quality video conversions from PAL (VHS). 1st hour \$40, each additional hour \$20. Other formats available. **G. LURIE**, PO Box 1305, Skokie, IL 60077.

WRITE FOR

McGEE'S

SPEAKER & ELECTRONICS CATALOG

1001 BARGAINS IN SPEAKERS

Tel.: 1 (816) 842 5092

1901 MCGEE STREET KANSAS CITY, MO. 64108

NEW video cassette rewinders for VHS and Beta. Prolong tape player life by saving wear and tear on video head. Soft-eject auto power cut-off when fully rewound. \$29.95. **PHILTRONICS**, PO Box 70386, Sunnyvale, CA 94086.

ELECTRONIC surveillance: Incredible manual, "Homebrew Bugging" outlines wiretapping, bugging, and other techniques used by professional operatives (schematics included)—\$15.00. We also have manuals on remote control, covert communications, survival, weaponry, exotic alarm systems, countermeasures, and more. Send \$3.00 for catalog: **A.T.I.S.**, Dept. R, Box 4068, Dearborn, MI 48126.

XENON FLASH LAMPS

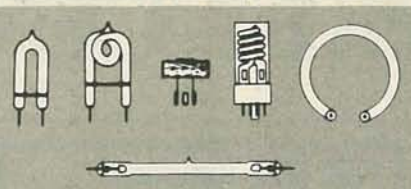

ASK FOR OUR NEW CATALOG. CALL OR WRITE FOR INFORMATION.

TEC/WEST (USA) INC.
10889 WILSHIRE BLVD., SUITE 740
LOS ANGELES, CA 90024-4299
CA: 213/208-5529 • OUTSIDE CA: 1-800-421-7215

MICROWAVE antennas 1.9-2.5 GHz. Down-converter prove, 21" solid aluminum dish, 65' cable power supply, 1 year warranty. **J&M ASSOCIATES**, 1902 Montecito Ave., No. 4 Mtn. View, CA 94043. Just \$69.00 + \$2.00 shipping, money order. (415) 969-7609.

MICROWAVE antenna system includes down converter dish coax power supply ready to use \$110.00. **SOUTH FLORIDA TECH.**, Box 523153, Miami, FL 33152.

TOTAL Computer Music. Most sophisticated ever. Classical, rock, oriental, funkola, space-age, etc. Half hour sampler cassette and catalog \$3.00. **MACROFUSION**, 40879-1 Highway 41, Oakhurst, CA 93644.

MICROWAVE dish \$75.00 complete. Cable converters, descramblers, satellite. Send **SASE** to **H.M.S.**, 2011 W. 11th St., Upland, CA 91786.

CABLE TV boxes & accessories. Complete units. Money-back guarantee. Catalog: \$2.00 (refundable). **VEEJER ELECTRONICS**, 2961 Industrial Rd., Dept. 199AR, Las Vegas, NV 89109.

RESISTANCE calibration box .25% five ranges \$14.95 plus \$2.25 postage and handling. **OHIO INSTRUMENTS**, 16659 Broadway, Maple Heights, OH 44137. Allow 4 to 6 weeks for delivery.

AMAZING electronic devices: VOX's, miniature transmitters, telephone transmitters, telephone wiretap defeats, telephone monitors, telephone recording equipment, remote control devices, and much more! Send \$3.00 for catalog: **A.T.I.S.**, Dept. R, Box 4068, Dearborn, MI 48126.

"Bare Power Supply Boards"

(FOR ALL TO-220 3 TERMINAL REGULATORS)

"Four Styles In Stock"

- 7800 Positive Fixed
- 7900 Negative Fixed
- 317T Positive Adjustable
- 337T Negative Adjustable

All Boards 2"x3" - G10
Silk Screened - Soldermasked
Make Projects A Snap!
Includes: Detailed Instructions
Parts Lists-Schematics-Design Tips

\$2.50 ea. - 4 for \$9.00 and \$1.00 postage & handling

MIDWEST TECHNICAL
P.O. BOX 272, AURORA, IL 60507

LSR UHF CONVERTERS

GATED pulse wave (speaker box type), has true AGC, parts \$125.00. The following have sound out of the TV like normal with only an antenna connection to the TV, VCR, or RF distribution switch box. Deluxe IIB sine wave, has true AGC, parts \$150.00. Digital sync suppression/active video inversion FV-4, has true AGC, parts \$225. Quantity discounts. Plans: large **SASE** (54 cents postage). Free shipping/handling. 1-312/267-3455. **LSR ENGINEERING**, Dept. RE, PO Box 6075, Chicago, IL 60680.

CB EQUIPMENT

CB radio books, kits, modifications, free catalog. **APS**, POB 263RE, Newport, RI 02840.

SATELLITE TV WEEK

The most complete weekly listings. Send \$1 for sample copy.



P.O. Box 308, Fortuna, California 95540
Call (800) 358-9997 • California (707) 725-9476

PLANS & KITS

SUBSCRIPTION TV manual, covers both sine wave and gated sync system, only \$12.95. Includes theory, circuits, waveforms, and trouble-shooting hints. Video game cartridges are easy and inexpensive to duplicate. Plans \$9.95. Information \$2.00, refundable. **RANDOM ACCESS** (Formerly D & S Enterprises), Box 41770R, Phoenix, AZ 85080.

CATALOG! 40 pages of neat electronics parts and kits. Send 50 cents, refundable first order. **BEC ELECTRONICS**, Box 01244R, Garland, TX 75046.

FUN kits—low cost. Easy to build educational electronics projects. Handbook/catalog \$1.00. **TRIANGLE ELECTRONICS**, 89 Arkay Drive, Hauppauge, NY 11788.

CONTROL and read up to 256 devices. Plugs into Radio Shack model III. Simple construction, software included. Plans \$15.00. **SPECIALTY ENGINEERING & MFG., Inc.**, PO Box 120, Gonzales, TX 78629.

PRINTED circuit boards. Quick prototypes, production, design, reflow solder. Send print or description for quote to **KIT CIRCUITS**, Box 235, Clawson, MI 48017.

LIGHT display sequencer kits. Send stamp for flyer. **DESIGN SPECIALTY**, P.O. Box 1995, Huntington Beach, CA 92647.

ELECTRONIC ORGAN KITS
3-4 Manuals

THEATER and CLASSICAL

Refundable Parts
Brochure \$2.00 Catalog \$2.00

Wurlitzer reproductions

DEVTRONIX ORGANS, INC., Dept 60
6101 WAREHOUSE WAY, SACRAMENTO, CA 95826

PROJECTION TV ... Convert your TV to project 7 foot picture. Results comparable to \$2,500 projector... Total cost less than \$200.00 ... Plans and lens \$17.50... Illustrated information free... Credit card orders 24 hours. (215) 736-3979. **MACROCOMA-GL**, Washington Crossing, PA 18977

ELECTRONIC touch light control pad five modes dim, medium, bright, delay, and off. Two kits available. Write for free brochure. **EXOTIC ELECTRONIC IDEAS**, PO Box 446, Lake Bluff, IL 60044.

SINE wave decoder problems? Manual includes trouble shooting, alignment, antenna hookup, improvements, theory. \$15.00. **SIGNAL**, Box 2512-R, Culver City, CA 90230.

MICROWAVE television "downconverters." Exclusive new five stage design. Easily assembled. Catalog: \$2.00 (refundable). **NDS**, Box 12652-R, Dallas, 75225.

NEW!... Repair any TV... Easy. Anyone can do it. Write: **RESEARCH**, Box 517E Brea, CA 92621.

FREE KIT Catalog

FUNCTION GENERATOR KIT \$59.95
Auto-Ranging Cap-meter kit \$79.95

contains TEST & EXPERIMENTER'S EQUIP.

Phone 209-772-2076

Write or Phone for FREE CATALOG

DAGE SCIENTIFIC INSTRUMENTS
BOX 144 VALLEY SPRINGS CA 95252

MULTI-LINE telephone system. Circuit plans for using standard multi-line phones with hold. Features include: hold, indicator lamps, ring indicator, up to five incoming lines, any number of phones. Works with existing phones, uses readily available parts. Send \$7.50 check or money order to: **SEITZ TECHNICAL**, PO Box 76, New London, PA, 19360.

MOST advanced sine converter descrambler available. PCB and plans \$15. **JIM RHODES**, 1025 Ransome Ln., Kingsport, TN 37660.

TELEPHONE busy light. Excellent for monitoring telephone usage, lights whenever any telephone is in-use. Plans \$5.00. **WGS**, PO Box 7363, Bellevue, WA 98008.

CABLE TV converters and equipment. Plans and parts. Build or buy. For information send \$2.00. **C & D ELECTRONICS**, PO Box 21, Jenison, MI 49428.

CABLE TV—converters, descramblers, plans and parts. For catalog, send \$2.00. **CROWN ELECTRONICS**, PO Box 352, Milton, FL 32570.

DESCRAMBLERS AMERICAN—CANADIAN

C-1000 / ZENITH TYPE

Descrambles "over the air" and "cable" sync suppressed active video inversion signals

Ready to go C-1000 **379.95**
Complete Kit C-1000K **274.95**
Printed Circuit & Manual **74.95**

C-100 / JERROLD TYPE

Cable Descrambler for in-band gated suppressed systems

Ready to go C-100 **119.95**
Complete Kit C-100K **54.95**

SEND \$2 FOR COMPLETE INFORMATIVE CATALOG TO DETERMINE WHAT TYPE YOU NEED.

FALL SPECIAL

Buy 1 kit
Get 2nd kit
at 1/2 price
Offer ends 10/1/83

J & D ENGINEERING
P.O. BOX 469
BOSTON, MA 02186
1-617-837-8431

Dealers Wanted
Special Quantity Pricing
COD's—OK

All J & D products are engineered, not copied, all are guaranteed 90 days & we stand behind our products where others fail to

SUBSCRIPTION TV out of set UHF sine wave type, PCB and plans \$16.50. In set UHF/VHF type, PCB and plans \$12.50. **RVB INDUSTRIES**, Box 663, Skokie, IL 60076.

PROGRAM your own EPROMS. Build a computerized thermostat. Send SASE for free details. **GLOVATRON**, PO Box 599, East Detroit, MI 48021.

VIC-20 owners: Make back-up copies of your cartridges' complete instructions and software. Send \$24.95 plus \$2.00 shipping: **ROBBEL ENTERPRISES**, 5326 Pointe Drive, Marine City, MI 48039.

SPECIAL news: Now you can buy many best electronics kits with our unbelievable low price and high quality. Write now for your absolutely free catalog. **INTERNATIONAL POLYTECHNIQUES**, PO Box 862, New York, NY 10002.

UPGRADE YOUR TELEPHONES

ADD THESE EASY-TO-INSTALL SPECIAL FEATURES

Hold Busy Silencer Circuit

Allows you to put calls on hold. Also lets you silence bell or put phone on busy. Plans: \$4.00, Kit: \$4.00 - \$2.00 phone.

Intercom Circuit

Lets you use phones as an intercom. No extra wiring required. Less costly than wireless models. Plans: \$7.00, Kit: \$15.00 - \$5.00 phone.

Kits include plans, parts and board. When ordering kits, add \$2.00 for postage. Send SASE for more information.

dB Enterprises Box 8 Oradell, NJ 07649

EXPERIMENTERS kits plans piezo electric fans, D.C. controls—complete kit \$29.95. Plans and fan \$15.00. Brochure \$2.00. **Wendel L. Daniels ENGINEERING CONSULTANT**, 84502 Anthony Wayne Ave., Cincinnati, OH 45216.

DIGITIZE any analog quantity. Build your own digital VOM, capacitance meter. Plans and schematics for 3 1/2 digit LED panel meter. Send \$2.00 to **DIGITAL DEVICES**, PO Box 511, Richmond, CA 94806.

SAVE 80%: Build your own home computer. Easy to follow plans and monitor programs. PC boards available for all circuits: 8080A or Z80A plans \$18.50, specify which. **ABLEONICS**, 225 Congress, No. 216, Austin, TX 78701.

FUNCTION generator kits: complete, full-featured instruments. Basic kit (VCO input): \$69.95. Built-in sweep generator (offset, span controls): \$89.95. **ADA INSTRUMENTS**, 1604 Morro No. 3, San Luis Obispo, CA 93401.

SATELLITE TV antenna. Why wait for cable! Do it yourself for less than \$200.00. Plans and materials list, only \$9.95. **HERITAGE ANTENNA SYSTEMS**, Box 14672, Fort Worth, TX 76117.

ROBOTICS books—build your own robot. Write now for free catalog. **KOHN/RE**, Box 16265, Alexandria, VA 22302.

TECHNI-TOOL inc.

TOOLS—TOOL KITS
FREE CATALOG
CALL (215) 825-4990

EXPERIENCE * QUALITY * VARIETY



FIND electronics parts! Our buyers' guide lists thousands of radio, computer, electronics, microwave, and mechanical parts, with who sells them by mail order to hobbyists. 75 suppliers and addresses. \$6.95 ppd. Fast response. **HALLWARD PRODUCTS**, 39N Sunset Court, St. Louis, MO 63121.

MEMORY boards, 14/2532's, new bare \$10.00. Add 28/56K RAM. Instructions, including VIC-20. Limited quantity. **RAM**, 4037 Cheshire, Cypress, CA 90630.

PROJECT boxes 8w 3h 6 1/2 d alum. bottom steel top rubber feet \$11.00 each no shipping handle. **LEE-WAY MANU. CO.**, PO Box 946, Buckley, WA 98321.

TIMEX Sinclair: schematics, software information on RAM, I/O, key board beep, RS232, monitor mod., data sheet, repair aid \$5.95. Add \$2.00 for ham radio package. Free product sheet. **SANTA FE**, 2335 S. Commerce Rd., Walled Lake, MI 48088.

VIC-20 schematic software information on RAM, port breadboarding, MX80 interface, short programs. \$3.95. Free product sheet. **SANTA FE**, 2335 S. Commerce Rd., Walled Lake, MI 48088.

DESCRAMBLERS! Largest supply USA—catalog \$3.00. **TV PRODUCTS CO.**, 635 Park Ave., Idaho Falls, ID 83402.

CATALOG— transmitters, linears, MDS downconverters, scramblers, broadcasting, CB, hobby plans & kits. \$1.00. **PANAXIS**, Box 130—F8, Paradise, CA 95969.

SATELLITE TELEVISION

SATELLITE antennas build 8-10-12 foot wood or metal from \$60. **PROTOTYPE ENGINEERS**, Box 1812, Deming, NM 88030.

SATELLITE TV receiver breakthrough! Build your own commercial quality receiver now! Instruction manuals, schematics, circuit boards! Send stamped envelope: **XANDI**, Box 25647, Dept. 21M, Tempe, AZ 85282.

INTERESTED in home satellite television—Don't buy anything until you've read **Homesat Handbook & Buyers Guide**. Our book tells everything about home satellite TV and may save you hundreds, even thousands of dollars in your selection and installation of a system! \$10.00. **H & G HOMESAT SERVICES**, Box 422, Seaford, NY 11783.

SATELLITE receiver, proven design. Easily constructed. Uses no exotic parts. Schematics and parts list—\$10.00. **H & S RESEARCH**, PO Box 521, Irmo, SC 29063.

DESCRAMBLERS! Largest supply USA—catalog \$3.00. **TV PRODUCTS CO.**, 635 Park Ave., Idaho Falls, ID 83402.

RF MODULATORS for the video industry

Satellite modulators from channel 2 thru UHF!
Kits & assembled models for all Microcomputers...including our new Apple-verter designed to mount inside computer. Also an extensive line of monitors, cameras and kits. FREE CATALOG

PHONE (402) 987-3771
ATV Research
13-RE BROADWAY
DAKOTA CITY, NE 68731

EDUCATION & INSTRUCTION

EARN your university degree through evaluation assessment, of existing education, experience, achievements. Call, (614) 863-1791, or write. **ASSESSMENT**, Box 13130 R, Columbus, OH 43213.

YOUR own radio station! AM, FM, cable, licensed, unlicensed. Low-cost transmitter kits, free info. **BROADCASTING**, Box 130-F8, Paradise, CA 95969.

TRANSIENT analysis and network theorems, two new texts by Dr. Harry E. Stockman, Request flyer. **SERCOLAB**, Box 78A, Arlington, MA 02174.

PAY TV / AMATEUR TV RECEIVERS

24 hour movies, specials, sports, etc.
GUARANTEED FINEST models anywhere!!
Write or Call for **FREE BROCHURE!**
JARIK, 632 West Doran, Suite "F"
Glendale, CA 91203, (213) 956-5839

BUSINESS OPPORTUNITIES

PROJECTION TV... Make \$\$\$ assembling projectors... Easy... Results comparable to \$2500.00 projectors... Your total cost less than \$17.00... **Plans, lens & dealers information \$15.50...** Illustrated information free... **MACROCOM-GLX**, Washington Crossing, PA 18977. Credit card orders 24 hours. (215) 736-2880.

DESCRAMBLERS! Largest supply USA—catalog \$3.00. **TV PRODUCTS CO.**, 635 Park Ave., Idaho Falls, ID 83402.

WHOLESALE MATV/CATV/VCR equipment, antennas, audio cables, adaptors, original & replacement cartridges & styl, telephone accessories, radios, cassette recorders, speakers, etc., send letterhead for free catalog (212) 897-0509. **D&WR**, 66-19 Booth, Flushing, NY 11374.

MONEY broker, commercial business loans to start, expand, etc. \$50,000 to millions. Send \$2.00. **LOREDO ENTERPRISES**, Box 2243, APO NY 09009.

MECHANICALLY inclined individuals desiring ownership of small electronics manufacturing business—without investment. Write: **BUSINESSES**, 92-R, Brighton 11th, Brooklyn, NY 11235.

LCD watches \$2.50, penwatch \$3.60, catalog \$1.00. **RELIANT ENGINEERING COMPANY**, PO Box 33610, Sheungwan, Hongkong.

VIDEO game repair business (Atari and Intellivision). Start your own. Information/parts list \$5.00. **IRATA**, 2562 East Glade, Mesa, AZ 85204.

BURGLAR alarm buyer's guide—How to start in security alarm business. Information \$2.00 (redeemable). **SECURITY ELECTRONICS INTERNATIONAL**, PO Box 1456-K, Grand Rapids, MI 49501.

HIGHLY PROFITABLE

ELECTRONIC FACTORY

Investment unnecessary, knowledge not required, sales handled by professionals. Ideal home business. Write today for facts!

Postcard will do, **Barta-RE-X**, Box 248, Walnut Creek, CA 94597.

COMPUTERS

TI-99/4A owners. Send for free list of new and exciting, low-cost software. **DYNA**, Box 124, Hicksville, NY 11801.

REEL TO REEL TAPES

AMPEX professional series open reel tape, 1800- or 2400-feet on 7-inch reels, used once. Case of 40, \$45.00. 10 1/2 x 3600 feet and cassettes available. MasterCard/Visa. **VALTECH ELECTRONICS**, Box 6-RE, Richboro, PA 18954 (215) 322-4866.

CABLE TV

CHANNEL 3—60dB notch filter. 63.5MHz. \$32. **CROSLEY**, Dept 606, Box 840, Champlain, NY 12919.

CB RADIO

GET more CB channels and range! Frequency expanders, boosters, speech processors, FM converters, PLL/slider tricks, how-to books, plans, modifications. Catalog \$2.00. **CB CITY**, Box 31500 RE, Phoenix, AZ 85046.

VIC-20

CAPACITOR tester/meter. Connects to userport. Displays values 10-PFD through 650-MFD. Indicates shorts and opens. Needs no extra memory. Guaranteed. Wired tester and cassette program, \$39.95. **SANDI ELECTRONICS**, 203 Cambridge Belton, MO 64012.



American Heart Association

WE'RE FIGHTING FOR YOUR LIFE

(602) 971-0990 (602) 971 0996

ARIZONA ELECTRONIC

SURPLUS
Wholesale - Retail - Surplus
Electronic Parts

12627 N. Cave Creek Rd. • Phoenix, AZ 85022

The Most Unbelievable Electrolytic Sale In The USA!

AXIAL		RADIAL	
33/6.3	12/1.00	1000/10	12/1.00
220/6.3	20/1.00*	10/16	30/1.00*
470/6.3	10/1.00	47/16	30/1.00*
220/10	15/1.00	220/16	25/1.00*
47/35	12/1.00	470/16	20/1.00*
220/35	10/1.00	47/25	20/1.00*
15/50	20/1.00*	47/100	5/1.00
22/50	20/1.00*	100/100	4/1.00
47/50	20/1.00*	47/160	10/1.00
150/50	8/1.00	10/160	10/1.00
220/50	8/1.00	22/250	5/1.00
10/75	12/1.00		
47/100	5/1.00*	BI-POLAR	
1500/100	2/1.00*	4/50	10/1.00
2.2/150	12/1.00	10/50	10/1.00
3.3/150	12/1.00	4/75	4/1.00
47/200	5/1.00	10/75	4/1.00
		Carbide Drill Bits	*1.00 ea.
		(various sizes to 3/8")	

* Yes All Prices Are Correct! • \$10.00 Minimum Order on All Above Capacitors • Some Quantity Pricing Available •

MORE \$1.00 SPECIALS

1N4001	15/1.00	Horz. P.C. Trimpots, 250Ω
2N3905	5/1.00	500Ω, 5kΩ, 10Ω
2SC828	5/1.00	MC3420P
2SC644	5/1.00	SN75150
MINI D.P.D.T. Slide	4/1.00	Transformer
D.P.D.T. Rocker Sw		12 V.C.T. 250 MA
4A. 120 VAC	3/1.00	7805
1N4152	25/1.00	7812
Similar to 1N914		1N5239
4 Pos DIP switch	3/1.00	9 V. ZENER
LED's		8/1.00

12V 6 A.H. Re-chargeable
GEL CELL BATTERY
\$9.95



Regulated Supply 5V, 2A

w/Transformer & 4" x 2.3" Heat Sink
\$5.50 ea. or 2/\$10.00

1½ WATT AMPLIFIER
w/DC Bridge

\$2.75 ea. or 2/\$5

Contains: Volume Control, (1) LM 386N, (1) NPN Pre-amp, (4) 4001 Diodes, (2) Coupling Caps
100% Functional! **NOT A KIT**

LIMITED QUANTITY!

\$3.29 ea. or 2/\$6

- 4 Scales**
- (1) R.F. Power 0-6
 - (2) SWR 1-10
 - (3) Modulation 0-100%
 - (4) Signal Strength 1-40
Ext. Shunt 2.3" x 2.3"



ITEMS MC, VISA, COD VIA UPS
(Plus Shipping/Handling)



CABLE TV EQUIPMENT

CABLE TV kits and equipment from \$39.95. Buy or build—see mini-ad. Catalog \$2.00: **J&W ELECTRONICS, INC.**, PO Box 61-L, Cumberland, RI 02864.

UHF DESCRAMBLERS

SINEWAVE kit \$37.00, gated sync kit \$39.00. Includes all parts, silk-screened PC board and complete instructions. Catalog \$2.00: **J&W ELECTRONICS, INC.**, PO Box 61-L, Cumberland, RI 02864.

DESCRAMBLERS—CABLE—UHF—TVRO

DESCRAMBLERS! Largest supply USA—catalog \$3.00. **TV PRODUCTS CO.**, 635 Park Ave., Idaho Falls, ID 83402.

WANTED

WANTED: old Western Electric, RCA, tubes, speakers, amplifiers. 713 7284343. **MAURY CORB**, 11122 Atwell, Houston, TX 77096.

AT LAST!!

CABLE TV equipment for "beeping" or "buzzing" channels. Details \$3.00. **CATV INFORMATION CENTER**, PO Box 17621, Ft. Laud., FL 33318.

ATARI-TIMEX/SINCLAIR

ATARI-TS/ZX81 free software/hardware catalog. New practical programs. Send two 20-cent stamps. **JPR SOFTWARE**, Box 4155 Winter Park, FL 32817.

SINCLAIR/TIMEX

DESIGN fully regulated dc pwr spls to your specs using our software. 16K \$24.95 **MACHINE** code editor run, list, edit using **BASIC** one key commands. Auto hex/dec conv. 16K \$16.95 both \$34.95. **MINDGATE**, Box 74, Kenmore, NY 14217.

TIMEX/SINCLAIR 1000

T/S 1000 16K programs on cassettes finance aid (barcharts, interest, record keeping). Math quiz (20 levels). **Electrosolve** (solves most electronic circuit problems). \$6.95 each. **BILL KEMP**, Box 26086, Bluff Park, AL 35226.

Radio-Electronics

SPECIAL REPRINT
BUILD A BACKYARD SATELLITE TV RECEIVER



Sixth Printing: Sold Out!
Seventh Printing—Just Off Press!
Reprints Now Available!

Don't miss out again!

Send away today for your 36-page booklet containing a complete reprint of all seven articles in the series on Backyard Satellite TV Receivers by Robert B. Cooper Jr.

This all-inclusive report gives you all the data you need to build your own Backyard Satellite TV Receiver.

■ **TELLS ALL ABOUT** domestic satellite communications, with full details on how you can pull those elusive TV signals from space.

■ **LEGAL REQUIREMENTS**, technical specifications, and how you, the

home constructor, can meet them. Find out what mechanical and electronics skills you need.

■ **RECEIVER CHARACTERISTICS**, technical details and specifications, along with examples of actual receivers built at comparatively low cost.

■ **ANTENNA DESIGN**... and exactly how you can build a spherical antenna, while keeping total earth-station cost for the complete system under \$1,000.

■ **THE FRONT END** is critical when you build your own system. We help you explore several different ap-

proaches to making one that will work for you.

■ **RECEIVER-SYSTEM** hardware, and how it goes together to bring you direct-from-satellite TV reception in your own home.

To order your copy: Complete coupon and enclose it with your check or money order for \$7.00, plus \$1.00 for postage and handling. We will ship your reprint within 6 weeks of receipt of your order. All others add \$4.00 for postage. New York State residents must add 58c sales tax.

Radio-Electronics

Satellite TV Reprints
45 East 17th Street
New York, N.Y. 10003

Please print

8-83

I want _____ reprints @ \$7.00 each, plus \$1. Handling & Postage.
I have enclosed \$ _____ . N.Y. State residents must add sales tax.

(Name)

(Street address)

(City)

(State)

(Zip)

SUMMER PROJECTS START WITH SHACK® PARTS

No Minimum Order! No Mail-Order Delays! See Before You Buy!

Ceramic TV-Sound Filters

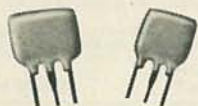

NEW!

Low As **69¢**

- Replace Costly Transformers
- Pre-Tuned, No Tweaking Needed

SFE4.5MB. Perfect for video projects! Will also replace 4.5 MHz sound transformer in many solid-state circuits. 3 dB bandwidth: 105 kHz, typical. 272-1304 **69¢**

CDA4.5MD3 Discriminator. Ceramic differential peak detector. Works great with our FM detector IC #276-1759. 272-1305 **79¢**

Sale! 10 x 10cm Solar Cell



Save \$5

Reg. 17.95 **12.95**

Harness "Free" Power That's Available Every Sunny Day!

Build a panel for charging batteries or powering projects. This quality cell, approximately 4" square, produces 0.42 VDC at 2 amps in full sun. Wire several in series for more voltage. 276-128 **Sale 12.95**

Deluxe LCD Autoranging Multimeter



NEW LOW PRICE!

69.95

Was \$89.95 in 1983 Catalog

- Handy "Beep" Continuity Checker
- Ready-to-Use, With Leads & Manual

The DVM that thinks! You choose the function, it selects range automatically—even if test leads are reversed. Selectable continuity and range-change "beep" indicator. Makes highly accurate low-resistance measurements. Low-battery and overrange indicators. Measures up 1000 volts DC, 500 volts AC, 200 milliamps (AC and DC), 2 megs resistance. Accuracy: ± 1 digit. $6\frac{3}{8} \times 3\frac{1}{2} \times 1\frac{3}{8}$ ". With spare fuse, test leads and manual. Requires two "AA" batteries. 22-192 **69.95**

Over-Voltage Sensor IC

NEW! 1.59

Protects Sensitive Electronic Circuits

8-Pin Dip With Data



MC3423. Monitors the supply rail and triggers an external LED or a crowbar SCR in the event of line transients or loss of regulation. Operates with supply voltages from 4.5 to 50 volts DC. 276-1717 **1.59**

Super Timer IC

NEW! 2.49

16-Pin DIP With Data

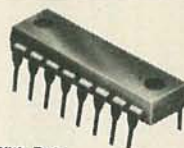

μ A2240 Programmable Timer Counter. Provides very accurate timing from microseconds to days. Consists of a time-base oscillator, an eight-bit counter, a control flip-flop and a voltage regulator. Frequency of the time base is set by external resistor and capacitor and can be synchronized or modulated. A time-base output may be used to monitor frequency or provide pulse to other circuitry. The eight outputs are TTL, DTL and CMOS compatible. 5 to 15VDC operation, single supply. 16-pin DIP with specs and data. 276-1735 **2.49**

Rectangular LED

Pkg. of 2

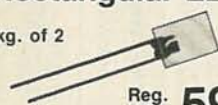

Reg. 99¢ **59¢**

Orange, high brightness type. Can be stacked vertically or horizontally. 276-074 **Sale, 2/59¢**



Double Closed Circuit Jack

1.59 3-Conductor Type

NEW!

For $\frac{1}{4}$ " phone plug. Can be wired to disconnect speakers automatically when stereo headphones are plugged in. 274-1240 **1.59**



Micro 5VDC Relay

NEW LOW PRICE! 1.99

Was \$2.49 in 1983 Catalog
Shown actual size—ideal for crowded boards. SPDT contacts: 1A at 125VAC. 55-ohm coil. 275-240 **1.99**

Micronta® Precision DC Panel Meters

NEW LOW PRICES!

7.95 Each

Were \$8.95 in 1983 Catalog



- Jeweled D'Arsonval Movements
- Accuracy $\pm 5\%$, Full Scale

Know "what's going on" in critical DC circuits. All are $2\frac{3}{4} \times 2\frac{1}{4} \times 1\frac{1}{4}$ " and require a $1\frac{1}{8}$ " round mounting hole.
0 to 50 Microamps. 270-1751 **7.95**
0 to 1 Milliamp. 270-1752 **7.95**
0 to 15 Volts. 270-1754 **7.95**



Panel Lettering

2.59 Cut **40%**

Four sheets with rub-on letters, symbols, numbers and calibration marks. 270-201 **2.59**

Tone-Dialing Encoder

16-Pin With Data



NEW! 3.99

Dependability At a Bargain Price!

TCM5089. Accurate, stable dual tone output—meets industry standards without adjustment. Just add keyboard (a pushbutton switch matrix will do), resistor, colorburst crystal (#272-1310) and power source to operate. Electronic input, too—usable in an auto-dial modem. Powered from phone line or 9VDC. 276-1301 **3.99**

Manufacturer's Prime Microwave Devices

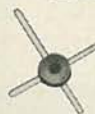

B 1.99

Pkg. of 2

A 2.99

A MRF-901. Low-noise NPN transistor for use up to 2 Gigahertz. 300 mW maximum dissipation. 276-2044 **2.99**

B H-P 5082-2835. Low-noise Schottky barrier diodes. Ideal for UHF and microwave mixers. 1 pF maximum capacitance. 276-1124 **Pkg. of 2/1.99**

Layout Template

Half Price Reg. 2.99

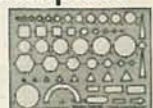

Durable, transparent stencil with 53 useful shapes. Really handy. $4\frac{1}{2} \times 6 \times \frac{1}{40}$ ". 276-181 **Sale 1.49**

Tantalum Capacitors



Low As **49¢** Each

- 20% Tolerance
- 16 WVDC Minimum
- Large Capacity in A Very Compact Size

μ F	Cat. No.	Each
0.1	272-1432	.49
0.47	272-1433	.49
1.0	272-1434	.49
2.2	272-1435	.59
10	272-1436	.69
22	272-1437	.79

SPST Toggle Switch With LED Indicator



NEW LOW PRICE! 2.59

Was \$2.99 in 1983 Catalog

Rated 5 amps, 12VDC only. $\frac{3}{4} \times \frac{3}{4} \times \frac{1}{2}$ ". $\frac{7}{16}$ " mounting hole. 275-680 **2.59**

DC Motor Bargain

99¢



For models, robots, etc. Long-life bearings. 1.5 to 6VDC. 273-222 **4/99¢**

Transformer, 6VAC

Save \$1

Reg. 2.99 **1.99**



Primary: 120VAC. Secondary 6.3VAC at 450 mA maximum. $1\frac{1}{16} \times 2\frac{3}{8} \times 1\frac{1}{2}$ ". Cut 33%. 273-1364 **Sale 1.99**

A DIVISION OF TANDY CORPORATION

Radio Shack®

OVER 8700 LOCATIONS WORLDWIDE

Prices apply at participating Radio Shack stores and dealers.

CIRCLE 86 ON FREE INFORMATION CARD

AUGUST 1983

111

**Number of Pins of each IC for easy Socket purchase

MICROPROCESSOR COMPONENTS



DT1050 Applications: Teaching aids, appliances, clocks, automotive, telecommunications, language translations, etc.

The DT1050 is a standard DIGITALKIT IC encased with 137 separate and useful words, 2 tones, and 5 different sentence durations. The words and tones have been assigned discrete addresses, making it possible to output single words or words concatenated into phrases or even sentences. The "voice" output of the DT1050 is a highly intelligible male voice. Female and children's voices can be synthesized. The vocabulary is chosen so that it is applicable to many products and markets.

The DT1050 consists of a Speech Processor Chip, MM54104 (40-pin) and two (2) Speech ROMs MM52164SR1 and MM52164SR2 (24-pin) along with a Master Word List and a recommended schematic diagram on the application sheet.

DT1050 Digitaker™ \$34.95 ea.

DT1057 Expands the DT1050 vocabulary from 137 to over 260 words. Incl. 2 ROMs and specs.

DT1057 Digitaker™ \$24.95 ea.

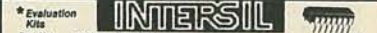

Table with columns: Part No., Pins, Function, Price. Lists various Intersil ICs like 7045PI/KIT, 7105EV/KIT, etc.

30009 1983 INTERSIL Data Book (1956 p.) \$9.95

NEW PRODUCT! 74HC High Speed CMOS

Table with columns: Part No., Pins, Function, Price. Lists 74HC series ICs like 74HC00, 74HC02, etc.

74HC04 is unbuffered. All others are buffered. Send \$3.00 for Data Sheet.

Programmable Array Logic (PALs)

Table with columns: Part No., Pins, Function, Price. Lists PAL series ICs like PAL10H8, PAL12H6, etc.

30012 1982 NATIONAL PAL Data Book (176 p.) \$9.95

74C-C/MOS

Table with columns: Part No., Pins, Function, Price. Lists 74C-C/MOS series ICs like 74C00, 74C02, etc.

LINEAR

Table with columns: Part No., Pins, Function, Price. Lists linear ICs like LM709N, LM733N, etc.

MICROPROCESSOR CHIPS

Table with columns: Part No., Pins, Price. Lists microprocessor chips like CDP1802, CDP1803, etc.

800/8000 SERIES

Table with columns: Part No., Pins, Price. Lists 800/8000 series ICs like MC6800, MC6801, etc.

8080A SERIES

Table with columns: Part No., Pins, Price. Lists 8080A series ICs like IN5800A, IN5801, etc.

MICROPROCESSOR MANUALS & DATA BOOKS

Table with columns: Part No., Price. Lists manuals and data books like M-Z80 User Manual, etc.

SPECIAL FUNCTION

Table with columns: Part No., Price. Lists special function ICs like D50025CN, D50026CN, etc.

SOLDERTAIL (GOLD) STANDARD

Table with columns: Part No., Price. Lists soldertail standard ICs like 8 pin LP, 14 pin LP, etc.

\$10.00 Minimum Order - U.S. Funds Only

California Residents Add 6 1/2% Sales Tax Shipping - Add 5% plus \$1.50 Insurance Send S.A.S.E. for Monthly Sales Flyer!

DYNAMIC RAMS

Table with columns: Part No., Pins, Price. Lists dynamic RAMs like 1103, 1024K1, etc.

STATIC RAMS

Table with columns: Part No., Pins, Price. Lists static RAMs like 1101, 256K1, etc.

EPROMS

Table with columns: Part No., Pins, Price. Lists EPROMs like 1702A, 2708, etc.

DATA ACQUISITION

Table with columns: Part No., Price. Lists data acquisition ICs like MC2470P, MC1408L7, etc.

LOW PROFILE (TIN) SOCKETS

Table with columns: Part No., Price. Lists low profile tin sockets like 8 pin LP, 14 pin LP, etc.

SOLDERTAIL (GOLD) STANDARD (TIN)

Table with columns: Part No., Price. Lists soldertail standard tin sockets like 8 pin ST, 14 pin ST, etc.

WIRE WRAP SOCKETS (GOLD) LEVEL #3

Table with columns: Part No., Price. Lists wire wrap sockets like 8 pin WW, 16 pin WW, etc.

MasterCard amecor ELECTRONICS VISA logo. 1355 SHOREWAY ROAD, BELMONT, CA 94002. 8/83 PHONE ORDERS WELCOME - (415) 592-8097 Telex: 176043



COMPUTER-PERIPHERAL SWITCHERS

Contact any number of peripherals to a single I/O port... RS232 SERIAL SELECTO-SWITCH

Switches all lines of asynchronous data... DB25 PARALLEL SELECTO-SWITCH

TRS-80, Apple, and IBM compatible... CENTRONICS-STYLE SELECTO-SWITCH

Switches all 36 lines... GCENT-AB 2-Way Switch... GCENT-ABC 3-Way Switch

Micro-Logic Corp. MICRO-CHARTS

Fully decoded data • Instant access • 2-sided, totally comprehensive... ML-280 Z80 CPU... ML-8080A 8080A/8085A

BOOKS

National CMOS Data Book (1981)... National Linear Data Book (1982)... National Memory Data Book (1980)

ATARI

ATARI PADDLES JSP (2) \$4.95 pair... ATARI DRIVER JSD (1) \$2.95 ea.

TV GAME SWITCH Used on Atari. Cosmetically blemished. 100% functional. TGS-1 \$2.95 ea.

Digital Thermometer Kit Dual sensors - switch controls for indoor/outdoor or dual monitoring... JE300 \$39.95

Universal Computer Keyboard Enclosures DTE-8 Panel Width 7.5" \$24.95... DTE-11 Panel Width 10.13" \$27.95

TIMEX Sinclair 1000

Powerful - fully programmable 2K memory • Portable - 6 1/2" x 6 1/2" x 1 1/2" • Expandable - Optional 16K RAM module

ACCESSORIES FOR TIMEX Sinclair 1000 and ZX81 TIMEX Sinclair 1016 Expansion from 2K to 16K... TIMEX Sinclair 2040 32 column thermal printer

Keyboard Mask for Your ZX81/1000* Computer

JE81 KEYBOARD MASK \$9.95 each... The JE81 Keyboard Mask provides users of the ZX81/1000 series computer the individual feel of each key

ZX81/1000* Keyboard Conversion Kit

JE62-AK Keyboard Conversion Kit \$99.95 ea. JE62 Keyboard Conversion Kit \$59.95 ea.

80-Key Keyboard

CA150C \$69.95

95-Key Keyboard

CA154A \$79.95

CONTROL DATA KEYBOARDS

7-bit Parallel ASCII • SPST Switching • FTZ Shielded Base • N-Key Rollover • 128 Character ASCII

Keytronic 90-Key Soft-Programmable Keyboard

Part No. KB270 \$79.95 each... MICRO SWITCH 85-KEY KEYBOARD... HI-TEK 14-KEY NUMERIC KEYPAD

POWER SUPPLY +5VDC @ 1 AMP REGULATED... POWER SUPPLY +5VDC @ 3 AMP REGULATED

POWER SUPPLY +5VDC @ 7.5 AMP, 12VDC @ 1.5 AMP SWITCHING... POWER SUPPLY 4-Channel Switching - Apple Compatible

\$10.00 Minimum Order - U.S. Funds Only... Spec Sheets - 30c each... Send \$1.00 Postage for your FREE 1983 JAMECO CATALOG

MasterCard JAMECO ELECTRONICS VISA 1355 SHOREWAY ROAD, BELMONT, CA 94002

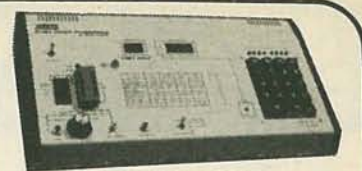

2708, 2716, 2732 & 2764 EPROM Programmer JE664 EPROM PROGRAMMER 8K TO 64K EPROMS

PROGRAMS 2716's IN 16 SECONDS... PROGRAMS 2764's IN 64 SECONDS... JE664-A EPROM Programmer \$995.00

Table with columns: Part No., EPROM, EPROM MANUFACTURER, PRICE. Lists various EPROM models and their prices.

iii's Black Hole EPROM Eraser

9 Chips - 8 Minutes... The Black Hole EPROM Eraser will completely and safely erase 9 EPROMs in less than 8 minutes.

IBM MEMORY EXPANSION KIT

SAVE HUNDREDS OF \$\$\$ BY UPGRADING MEMORY BOARDS YOURSELF! IBM64K (Nine 200ns 64K RAMs) \$59.95

EXPAND YOUR MEMORY

TRS-80 to 16K, 32K, or 48K... TRS-16K3 *200ns for Color & Model III \$12.95

TRS-80 Color 32K or 64K Conversion Kit

Easy to install kit comes complete with 8 ea. 4164-2 (200ns) 64K dynamic RAMs & conversion documentation.

5 1/4" Mini-Floppy Disk Drive

FOR TRS-80 MODEL I - COLOR COMPUTER... FD200 Single-sided, 40 tracks, 250K bytes capacity \$179.95

8" FLOPPY DISK DRIVE

The FDD100-8" Floppy Disk Drive (Industry Standard) features single or double density... FDD100-8 \$169.95 ea.



FORMULA INTERNATIONAL INC.

12603 Crenshaw Blvd., Dept. B, Hawthorne, CA 90250

For information (213) 973-1921 • Orders Only (outside Calif.) (800) 672-8758



POCKET LIGHT

Complete with 5" fluorescent tube, powerful bulb and handy strap. Runs on 3 pcs 1.5V "C" size batteries (not included). It's a practical, convenient, powerful spotlight and fluorescent light. Its superior quality is ideal for indoor or outdoor use.

LOW PRICE \$7.50

SANYO UHF VARACTOR TUNER

FOR UHF CHANNELS 14-83

Tuning voltage +1 to +28VDC. Input impedance 75Ω. IF band width 7-16MHz. Size 2 1/2" x 1 1/4" x 3/4". Supply voltage 15VDC.

Model 115-B-403A, Video IF 45.0MHz

Model 115-B-405A, Video IF 62.5MHz

\$35.00 ea.

Tuner is the most important part of the circuit. Don't let those \$19.00 tuners fool you.

All units are brand new from Sanyo. When ordering please specify model number.



AUDIO FREQUENCY SPECTRUM ANALYSER KIT TA-2900

This Audio Frequency Spectrum Analyser analyses audio signals in 10 octaves over a dynamic range of 30dB. The technique allows the sound coloration introduced by unwanted room and speaker resonances to be substantially eliminated.

The TA-2900 provides a visual presentation of the changing spectrum thru 100 red LED displays, so you can actually see proof of the equalized sound you've achieved. The TA-2900 kit comes with all the electronic components, IC's, predrilled PC Board, the instructions and a 19" Rack Mount type metal cabinet with professional silk screen printed front panel.

- Input Sensitivity Tape Monitor: 10mV-18mV 50KΩ. Speaker Terminal 0.2W-100W 8Ω.
- Display Level Range (all octaves) 2dB per step -14dB to -4dB.
- Delay Time (1KHz) Fast: 18dB/s Slow: 6dB/s.
- Power Input 117.220VAC, 50-60Hz.
- Power Consumption 36W.
- Dimensions 482(W) x 102(H) x 250(D) mm.

\$99.50 per Kit



TA-1000 KIT \$51.95

Power Transformer \$24.00 ea.



100W CLASS A POWER AMP KIT

Dynamic Bias Class "A" circuit design makes this unit unique in its class. Crystal clear, 100 watts power output will satisfy the most picky fans. A perfect combination with the TA-1020 low TIM stereo pre-amp.

Specifications • Output power 100W RMS into 8Ω. 125W RMS into 4Ω • Frequency response 10Hz-100KHz • THD less than 0.01% • S/N ratio better than 80dB • Input sensitivity 1V max. • Power supply ±40V at 5A.

1 WATT AUDIO AMP

All parts are pre-assembled on a mini PC Board. Supply voltage 6-9VDC. **Special Price \$1.95**

6W AUDIO AMP KIT

TBA810 with Volume Control. Power Supply 6-18VDC. **Only \$7.50 ea.**

LASER SUPER LATERN

Brilliant fluorescent lantern with 9" 6 watt fluorescent tube. Features include Powerful direct beam spotlight with 9V pre-focus bulb. Buzzer horn - either constant or time intervals of sonic alarm; Twin blinker - red amber flashing or red & amber flashing on time intervals; Fully adjustable nylon strap. Operates from D size batteries or plugs into vehicle cigar lighter socket.

SPECIAL \$11.95

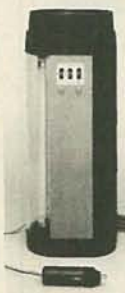

6-WAY A/C ADAPTOR

Input: 110VAC. Output: 3V, 4.5V, 6V, 7.5V and 12VDC. Current: 300mA.

OUR LOW PRICE \$5.50 ea.

No FCC License Required

OUR PRICE \$49.50
Additional Microphone (Transmitter) Available at \$28.00 ea.
MURA WMS-49

CRYSTAL CONTROLLED WIRELESS MICROPHONE SYSTEM

Transmitter: FET mic for flat 30Hz-18KHz response. X'tal controlled 49MHz AM Band for drift-free performance. 100mW output (range approx. 1/4 mile) for reliable long range transmission. Powered by a 9V radio battery.



Receiver: X'tal controlled locks on 49MHz transmitter signal. On panel VU meter, monitors the signal strength from the microphone. Standard phone jack outlet connection to a P.A. or other phone input. 9V battery included. This professional set is ideal for on stage, in field, church, in house or outdoor use.

A GOOD BUY at \$65.00 TA-800



120W PURE DC POWER STEREO AMP KIT

Getting power hungry from your small amp? Here's a good solution! The TA-800 is a pure DC amplifier with a built-in pre-amp. All coupling capacitors are eliminated to give you a true reproduction of the music. On board tone and volume controls combined with built-in power supply make the TA-800 the most compact stereo amp available. Specifications: 60W x 2 into 8Ω. Freq Range: 0Hz-100KHz ±3dB. THD: 0.1% or better, S/N Ratio: 80dB. Sensitivity: 3mV into 47K. Power Requirement: ±24-40 Volts.

"FISHER" 30 WATT STEREO AMP

MAIN AMP (15W x 2). Kit includes 2 pcs. Fisher PA 301 Hybrid IC, all electronic parts with PC Board. Power supply ±16VDC (not included). Voltage gain 33dB, 20Hz-20KHz.

Super Buy Only \$18.50

WHISTLE ACTIVATED SWITCH BOARD

All boards are pre-assembled and tested. You whistle to its FET condenser microphone from a distance, as far as 30 feet away (sensitivity can be easily adjusted), and it will turn the switch on. If you whistle again it will turn off. Ideal for remote control toys, electrical appliance such as lights, coffee pots, TV, Hi-Fi, radio or other projects. Unit works on 9VDC.

Model 968 **\$2.50 ea.**

ULTRASONIC SWITCH KIT

Kit includes the Ultra Sonic Transducers, 2 PC Boards for transmitter and receiver, all electronic parts and instructions. Easy to build and a lot of uses such as remote control for TV, garage door, alarm system or counter. Unit operates by a 9-12VDC. **\$15.50 ea.**

UNIVERSAL NI-CD BATTERY CHARGER MW-398



Charges 9V, AA, C or D size Ni-CD batteries all at one time.

Part No. 050-0190 **\$11.50 ea.**

SUPER FM WIRELESS MIC KIT

This new designed circuit uses high FREQ FET transistors with 2 stage pre-amp. Transmits FM range (88-120MHz) up to 2 blocks away and with the ultra sensitive condenser microphone that comes with the kit allows you to pick up any sound within 15 ft. away. Kit includes all electronic parts, OSC coils and PC Board. Power supply 9VDC.

FMC-105 **\$11.50 per Kit**

PROFESSIONAL FM WIRELESS MICROPHONE

Made by one of the leading Japanese manufacturers. This factory assembled FM wireless microphone is powered by two AA size batteries. It transmits in the range of 88-108MHz. Element is built in a plastic tube type case with an omni-directional electronic condenser microphone unit. By using a standard FM radio, signal can be heard anywhere on a one acre lot. Sound quality was judged "very good." MODEL WEM-36 was \$16.50.

ON SALE **\$8.25 ea.**

HEAVY DUTY 500mA MULTIPLE AC-DC ADAPTOR

For all battery operated electronic equipment up to 500mA with LED indicator.



Input: 117/220VAC, 50-60Hz
Output: 3, 4.5, 6, 7.5, 9 and 12VDC.
Model SA-8112A **\$25.00 ea.**

SANYO ANTENNA SIGNAL BOOSTER

This Booster is specially designed for UHF Channels (14-83). After installing between the antenna input cable and the UHF tuner, this unit will provide a minimum of 10dB gain, that is approximately 2 times better than you are seeing now. Ideal for those who live in apartments that can not put up an outdoor antenna. Small in size, only 2" x 1 1/2" x 1". Supply voltage is 15 VDC.

Model 001-0076 **\$12.50**

PROFESSIONAL REGULATED VARIABLE DC POWER SUPPLY KIT

All solid state circuitry with high efficiency power transistor 2SD388 and IC voltage regulator MC1733. Output voltage can be adjusted from 0-30V at 1A current limited or 0-15V at 2A current limited. Internal resistance is less than 0.005Ω, ripple and noise less than 1mV, dual on panel meters for voltage and current reading, also with on board LED and audible over load indicator. Kit comes with pre-drilled PC Board, instructions, all necessary electronic components, transformer and a professional looking metal cabinet. The best project for school and the most useful instrument for repairmen. Build one today!



Model TR88A 0-15VDC (1A)
Model TR88B 0-30VDC (1A)

\$59.50 per Kit

FLOURESCENT AUDIO LEVEL MONITOR

This is the kind of VU monitor that is being used by most amplifier manufacturers. IC's are used to simplify circuit layout. Easy to assemble and can be used with all power level amplifiers. Power requirement 12VDC.



TE-221 KIT For Just \$28.50 (Limited Stock)

REGULATED DUAL VOLTAGE SUPPLY KIT ±10-30VDC @ 250mA adjustable fully regulated. Kit includes all electronic parts, filter capacitors, IC's, heat sinks and PC Board. **\$12.50 per Kit**

MARK IV - 15 STEP LED POWER LEVEL INDICATOR KIT

This new stereo indicator kit consists of 36 4-color LEDs (15 per channel) to indicate the sound level output of your amplifier from -36dB to +3dB. Comes with a well designed silk screen printed plastic panel and has a selector switch to allow floating or gradual output indicating. Power supply is 6-12VDC with THG on board input sensitivity controls. This unit can work with any amplifier from 1W to 200W. Kit includes 70 pcs driver transistors, 38 pcs matched 4-color LEDs, all electronic components, PC Board and front panel.

MARK IV KIT **\$31.50**



LOW TIM DC STEREO PRE-AMP KIT TA-1020

Incorporates brand-new DC design that gives a frequency response from 0-100KHz ±0.5dB. Added features like tone defeat and loudness control let you tailor your own frequency supplies to eliminate power fluctuations!

Specifications: • THD TIM less than .005% • Frequency response DC to 100KHz ±0.5dB • RIAA deviation ±0.2dB • S/N ratio better than 70dB • Sensitivity: Phone 2mV 47KΩ. Aux 100mV 100KΩ • Output level 1.3V • Max output 15V • Tone controls: Bass ±10dB @ 50Hz. Treble ±10dB @ 15Hz • Power supply ±24VDC @ 0.5A. Kit comes with regulated power supply. All you need is a 48VCT transformer @ 0.5A.

Only \$44.50 Transformer \$4.50 ea.



★ SPECIAL ★ Excellent Price!
Model 001-0034 **\$29.50 per Kit**
Transformer **\$10.50 ea.**

TA-322 30 WATTS TOTAL 15W + 15W STEREO AMP KIT

This is a solid state all transistor circuitry with on board stereo pre-amp for most microphone or phone input. Power output employs a heavy duty Power Hybrid IC. Four built on board controls for volume, balance, treble and bass. Power supply requires 48VCT 2.5A transformer. THD of less than 0.1% between 100Hz-10KHz at full power (15 Watts + 15 Watts loaded into 8Ω).

ELECTRONIC SWITCH KIT

CONDENSER TYPE Touch On — Touch Off. Uses 7473 IC and 12V relay. **\$5.50**

POWER SUPPLY KIT

0-30VDC REGULATED. Uses UA723 and 2N3055 power transistor. Output can be adjusted from 0-30V @ 2A. Complete with PC Board and all electronic parts.

Transformer \$9.50 ea. **POWER SUPPLY KIT \$10.50 ea.**

FLOURESCENT LIGHT DRIVER KIT

12VDC Powered. Lights up 8-15 Watt Fluorescent Light Tubes. Ideal for camper, outdoor, auto or boat. Kit includes high voltage coil, power transistor, heat sink, all other electronic parts and PC Board. Light tube not included. **\$6.50 per Kit**

ELECTRONIC DUAL SPEAKER PROTECTOR

Cuts off when circuit is shorted or over loaded to protect your amplifier as well as your speakers. A must for OCL circuits. Kit Form **\$9.75**

SOLAR CELLS

0.5V 200mA. Ideal for all kinds of solar projects. Cells can be put in series to double voltage or parallel to double current. **99c ea.**

SEND ONE DOLLAR FOR OUR DETAIL CATALOG

Shipping & Handling Charges Under \$50.00 Under \$50.00

Purchase	Under \$50.00	Purchase	Over \$50.00
Inside California	10%	Outside Calif. (incl. Mexico & Canada)	15%
Overseas	25%		20%

Minimum Order \$10.00/Calif. Residents add 6.5% Sales Tax. Phone Orders Accepted on VISA or MC ONLY. NO C.O.D.'s. Prices subject to change without notice.



STORE HOURS
MON-FRI—10-7
SAT—10-6

*Apple and Apple II are the trademark of APPLE COMPUTERS, INC.

WE HAVE QUALITY PARTS, DISCOUNT PRICES AND FAST SHIPPING!

TRANSFORMERS

120 volt primaries

5.6 VOLTS at 750 MA	\$3.00
6 VOLTS at 150 MA	\$1.25
16.5 V. at 3 AMPS	\$6.50
18 V at 650 MA	\$3.50
18 VOLTS at 1 AMP	\$4.50
18 V.C.T. at 2 AMP	\$5.50
24 VOLTS at 250 MA	\$2.50
24 VCT at 1 AMP	\$4.50
42 V.C.T. at 1.2 AMP	\$4.50

BLACK PLASTIC CASE

PAC-TEC SERIES C



BLACK PLASTIC ENCLOSURE ADJUSTABLE HEIGHT FROM 1.63" TO 2.93"; WIDTH 6.85"; DEPTH 8". BUILT-IN STAND OFFS FOR P.C. BOARDS... FRONT AND BACK PANELS NOT INCLUDED...

\$5.25 PER CASE

T.V. GAME SWITCH

RCA PLUG or 300 OHM IN



300 ohms OUT

\$2.75 EACH

LIGHTS

GRAIN OF WHEAT T1 SIZE



.125" DIA. (3.15mm)

3 to 6 VOLTS 3 for \$1.00
Rated: 55ma @ 5 VOLTS

6 to 12 VOLTS 3 for \$1.00
Rated: 55ma @ 8 VOLTS

12 to 24 VOLTS 3 for \$1.00
Rated: 45ma @ 14 VOLTS

12 VOLT A.C. POWER UNIT



THIS UNIT CONSISTS OF A 12 VOLT 2 AMP TRANSFORMER, 1 AMP CIRCUIT BREAKER, 4 PRONG CINC JONES SOCKET AND A 3 WIRE A.C. CORD ALL MOUNTED IN AN ATTRACTIVE 4 1/2" x 5 1/2" x 3" CHASSIS BOX. GOOD FOR PARTS OR A NICE START FOR D.C. POWER SUPPLY.

\$8.50 PER UNIT

DC WALL TRANSFORMER

ALL ARE 115 VAC PLUG IN



4 VDC at 70 MA	\$2.50
9 VDC at 225 MA	\$3.00
16.5 VAC at 10 VA	\$3.50
17 VAC at 500 MA	\$4.00
22 VDC at 60 MA	\$2.50

2K 10 TURN

MULTI-TURN POT



SPECTROL #MOD 534-7161

\$5.00 EACH

S.C.R.

0.8 AMPS 30 VOLTS 5 for \$1.00

4 AMPS 200 VOLTS 65¢ EACH

4 AMPS 500 VOLTS 85¢ EACH

T1 SIZE WITH WIRE LEADS



3 to 6 VOLTS 2 for \$1.00
Rated: 55ma @ 5 VOLTS

6 to 12 VOLTS 2 for \$1.00
Rated: 55ma @ 8 VOLTS

12 to 24 VOLTS 2 for \$1.00
Rated: 45ma @ 14 VOLTS

CO-AX SWITCH (A/B SWITCH)

75 ohms IN TWO



75 ohms OUT

\$3.50 EACH

LINE CORDS

TWO WIRE



6' 18ga TWO WIRE 3 FOR \$1.00

THREE WIRE

18 INCH 18ga THREE WIRE 2 for \$1.00

8 FOOT 18ga THREE WIRE \$2.00 EACH

VARACTOR DIODE

MV2205 3 FOR \$1.00
16 PF 100 FOR \$30.00



BB-103 3 for \$1.00
33 PF 100 FOR \$30.00

MIKE CONNECTOR



5 CONDUCTOR IN-LINE PLUG AND CHASSIS MOUNT JACK. TWIST LOCK STYLE. SAME AS SWITCHCRAFT 12CL5M

\$2.50 PER SET

TRIAC

6 AMPS 400 VOLTS 75¢ EACH

T1- 3/4 SIZE WITH WIRE LEADS



163" DIA. (4.14mm)

3 to 6 VOLTS 2 for \$1.00
Rated: 45ma @ 6 VOLTS

6 to 12 VOLTS 2 for \$1.00
Rated: 55ma @ 8 VOLTS

12 to 24 VOLTS 2 for \$1.00
Rated: 45ma @ 14 VOLTS

METERS 0 - 20 V.D.C.

0-20 VDC FULL SCALE FACEPLATE BATTERY TEST SET-UP AS INDICATOR



\$5.50 EACH

1 MA



2 5/16" SQUARE PANEL METER MOUNTS IN 2 1/8" HOLE

\$5.50 EACH

SWITCHES MINI-PUSH BUTTON

S.P.S.T. MOMENTARY NORMALLY OPEN 1/4" BUSHING



35¢ EACH

10 FOR \$3.25

100 FOR \$30.00

SPECIFY COLOR: RED, BLACK, WHITE, GREEN, YELLOW.

2 CHANNEL LIGHT ORGAN

EASILY HOOKS INTO STEREO SPEAKERS AND ALLOWS 110 VAC LIGHTS TO DANCE WITH MUSIC. TWO SEPARATE 110 VAC OUTPUTS FOR HIGH AND LOW FREQUENCY AUDIO SIGNALS. USE TWO ORGANS FOR STEREO...



\$6.50 PER UNIT

COLOR LIGHT STRING AVAILABLE \$1.75 EA

CRYSTALS

CASE STYLE HC33/U

2 MHZ COLORBURST 3579.545 KC

\$3.50 EACH \$1.00 EACH

TRANSISTORS

2N706	5 for \$1.00
2N2222A	4 for \$1.00
PN2222	8 for \$1.00
2N2904	4 for \$1.00
2N2905	4 for \$1.00
2N2907	4 for \$1.00
MJ3030	\$2.50
2N3055	\$1.00
2N3585	\$1.00
2N3904	5 for \$1.00
2N3906	5 for \$1.00
2N4401	5 for \$1.00
2N4403	5 for \$1.00
2N4998	\$1.50
D43C8	2 for \$1.00
D44C2	.75
TIP 31	.75
TIP 32	.75
TIP 121	.75
TIP 126	.75

NEON W/ RESISTOR

DIRECT OPERATION FROM 120V

7 for \$1.00

0 - 15 V.D.C. SQUARE METER



MEASURES 0-15 VDC

\$4.50 EACH

KEY SWITCH

S.P.S.T. THIS 2-1/4" SQUARE METER MEASURES 0-15 VDC



4 AMPS @ 125 VAC KEY REMOVES BOTH POSITIONS

\$3.50 EA

METAL OXIDE VARISTOR



2 FOR G.E. # V822A12 \$1.50

50 VOLTS, NOMINAL D.C. VOLTAGE 5/8" DIAMETER.

LIGHTED PUSH BUTTON



RED LIGHTED 120 VAC 10 AMP. S.P.S.T. "POWER" PRINTED ON FACE. MOUNTS IN 7/8" SQUARE HOLE.

\$1.50 EA 10 FOR \$13.50

FREE! FREE! free! SEND FOR OUR NEW 40 PAGE CATALOG free! FREE! FREE!

2-WAY CAR STEREO SPEAKER SYSTEM



THESE SPEAKERS COME IN HEAT RESISTANT ABS PLASTIC CABINETS. IDEAL FOR CAR INTERIORS WHERE HEAT CHANGE OCCURS... POWER RATING: 15 WATT NOM. 45 WATT MAX. EACH SYSTEM CONTAINS A 4 INCH 10 OZ. WOOFER AND 2 INCH TWEETER

SPECIAL PRICE \$36.00 PER PAIR

RELAYS

6 VDC RELAY



MINIATURE D.P.D.T. 3 AMP CONTACTS FUJITSU # FBR321D006

\$1.75 EA 10 / 16.00

COMPUTER GRADE CAPACITORS



1700 mfd. 150 VDC \$2.00
2 1/2" DIA x 4 3/4" HIGH

3,600 mfd. 40VDC \$1.00
1 3/8" DIA. x 3" HIGH

6,400 mfd. 60 VDC \$2.50
1 3/8" DIA. x 4 1/4" HIGH

18,000 mfd. 75 VDC \$4.00
2 1/2" DIA. x 4 1/2" HIGH

22,000 mfd. 15 VDC \$2.00
2" DIA. x 2 1/2" HIGH

24,000 mfd. 40 VDC \$3.00
2" DIA. x 6" HIGH

24,000 mfd. 30 VDC \$3.50
1 3/4" DIA. x 4" HIGH

31,000 mfd. 15 VDC \$2.50
1 3/4" DIA. x 4" HIGH

72,000 mfd. 15 VDC \$5.00
2" DIA. x 4" HIGH

180,000 mfd. at 6V \$1.50
2 1/2" DIA. x 4 1/2" HIGH

\$1.50 EA. CLAMPS TO FIT CAPACITORS \$0.45 ea.

EDGE CONNECTORS



ALL ARE .156" SPACING

15 PIN GOLD SOLDER EYELET \$1.75 EACH

15/30 GOLD SOLDER EYELET \$2.00 EACH

18/36 GOLD SOLDER EYELET \$2.00 EACH

22/44 GOLD SOLDER TAIL (P.C. STYLE) \$2.50 EA 10 FOR \$22.50

L.E.D.'S STANDARD JUMBO DIFFUSED



RED 10 FOR \$1.50

GREEN 10 FOR \$2.00

YELLOW 10 FOR \$2.00

FLASHER LED 5 VOLT OPERATION RED JUMBO SIZE \$1.00 EACH

BI POLAR LED 2 FOR \$1.70

SUB-MINI LED

079" x .098" 20 MA AT 1.75V

RED 10 FOR \$1.00

200 FOR \$18.00

GREEN 10 FOR \$1.50

KEY ASSEMBLY 5 KEY



CONTAINS 5 SINGLE-POLE NORMALLY OPEN SWITCHES. MEASURES 3 3/4" LONG

\$1.00 EACH

SLIDE POTS



100K linear tape

2" LONG 1 5/8" TRAVEL 75¢ EACH

500K linear taper

2 7/8" LONG 1 3/4" TRAVEL 75¢ EACH

DUAL 100K audio taper

3 1/2" LONG 2 1/2" TRAVEL \$1.50 EACH

MINIATURE 6 VDC RELAY



SUPER SMALL SPDT RELAY; GOLD COBALT CONTACTS.

RATED 1 AMP AT 30 VDC; HIGHLY SENSITIVE, TTL DIRECT DRIVE POSSIBLE, OPERATES FROM 4.3 TO 6 V. COIL RES. 220 OHM.

1 3/16" x 13/32" x 7/16" AROMAT # RSD-6V

\$1.50 EACH 10 FOR \$13.50

SOLID STATE RELAY



CONTROL: 3-32VDC

LOAD: 10 AMP 140 VAC

\$9.50 EACH

LED HOLDERS

TWO PIECE HOLDER FOR JUMBO LED

10 FOR 65¢ 200 FOR \$10.00

POWER SUPPLY W/ PRE-AMP



THIS SUPPLY WAS USED TO POWER AN 8 TRACK/CASSETTE UNIT. IT WILL SUPPLY APPROX. 18 VDC AND INCLUDES A SMALL PRE-AMP TO BOOST SIGNAL LEVEL. RCA PLUGS FOR LINE IN/OUT.

\$4.50 EACH

13 VDC RELAY



CONTACT: S.P.N.C. 10 AMP @ 120 VAC ENERGIZE COIL TO OPEN CONTACT... COIL: 13 VDC 650 OHMS

SPECIAL PRICE \$1.00 EACH

MINIATURE TOGGLE SWITCHES

ALL ARE RATED 5 AMPS @ 125 VAC

S.P.D.T. (on-on) P.C. STYLE, NON-THREADED BUSHING. 75¢ EACH 10 FOR \$7.00

S.P.D.T. (on-on) SOLDER LUG TERMINALS \$1.00 EACH 10 FOR \$9.00 100 FOR \$80.00

S.P.D.T. (on-off-on) SOLDER LUG TERMINALS \$1.00 EACH 10 FOR \$9.00 100 FOR \$80.00

S.P.D.T. (on-on) P.C. LUGS, THREADED BUSHING. \$1.00 EACH 10 FOR \$9.00 100 FOR \$80.00

D.P.D.T. (on-on) SOLDER LUG TERMINALS \$2.00 EACH 10 FOR \$19.00 100 FOR \$180.00

PHOTO-FLASH CAPACITORS



35 MFD 330 VOLT

1" x 5/8" DIA. 45¢ EACH... 10 FOR \$4.00

170 MFD 330 VOLT

1 1/8" x 7/8" 2 FOR \$1.50 10 FOR \$7.00

750 MFD 330 VOLT

2" HIGH x 1 1/4" DIA. \$1.25 EACH 10 FOR \$11.00

TOLL FREE ORDERS ONLY 1-800-826-5432 (ORDER ONLY)

ALASKA, HAWAII, CALIF OR INFORMATION (213) 380-8000

ALL ELECTRONICS CORP.

ALL ELECTRONICS CORP.

905 S. Vermont Ave. P.O. BOX 20406 Los Angeles, Calif. 90006

QUANTITIES LIMITED MINIMUM ORDER \$10.00 USA: \$2.50 SHIPPING FOREIGN ORDERS: INCLUDE SUFFICIENT SHIPPING CALIF. RES. ADD 6% NO C.O.D!

AUGUST 1983

CIRCLE 73 ON FREE INFORMATION CARD

"The Deluxe II"

Is The Ultimate In UHF Sine Wave Converter Technology

PC BOARD & PLANS \$20.00

With purchase of COMPLETE SET OF PARTS & ENCLOSURE

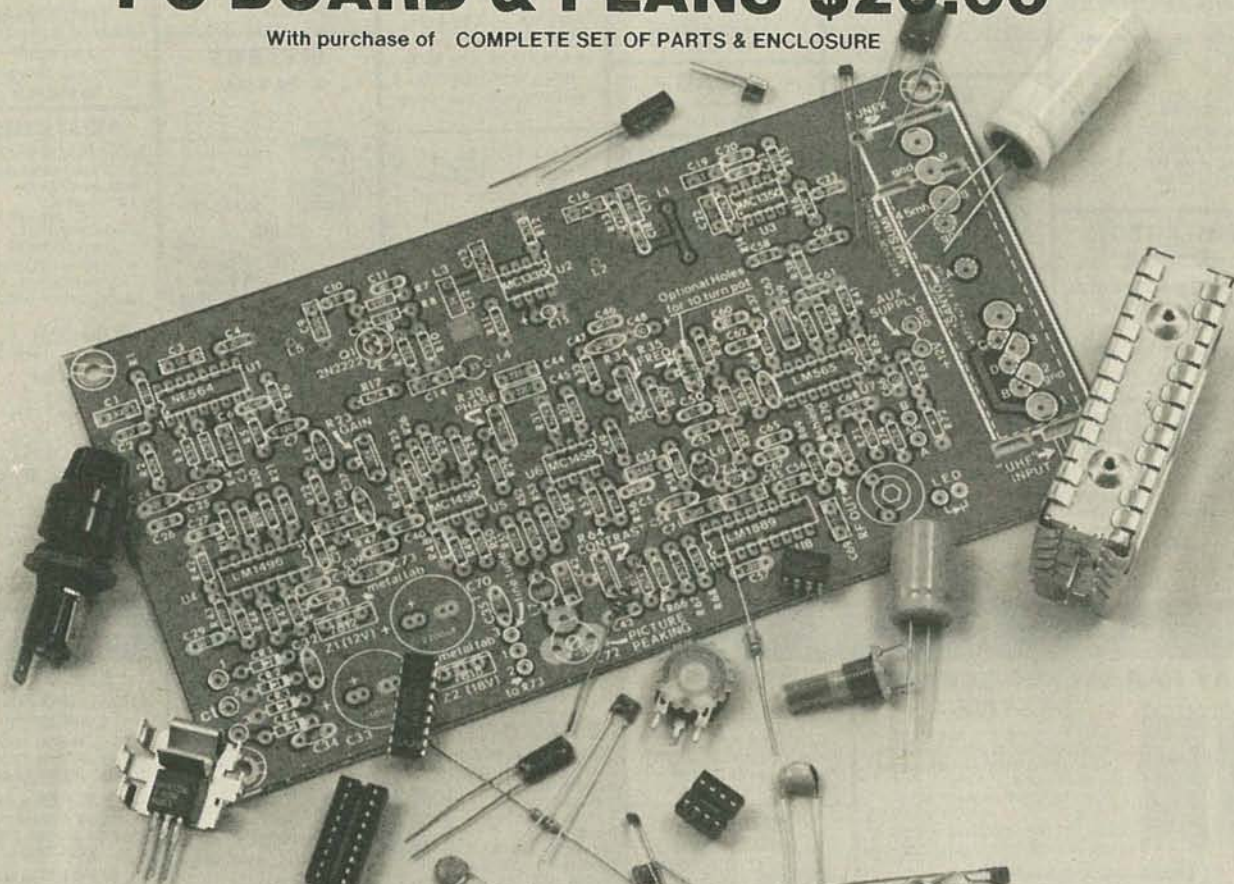

The latest state of the art electronics combined with the excellence in printed circuit manufacturing creates this high performance UHF Sine Wave Converter kit that outperforms the imitations by a long shot.

Engineered for reliable stability and outstanding reception clarity, uninterrupted modulated audio and fully illustrated instructions with the amateur in mind.

TOLL FREE

BETA ELECTRONICS, 1700 E. DESERT INN ROAD, SUITE 222, LAS VEGAS, NEVADA, 89109 **1-800-782-2701**

QTY	DESCRIPTION OF ITEM	COST EACH	SHIPPING EACH	TOTAL
	PC BOARD, PLANS, PARTS & ENCLOSURE	\$152.99	\$4.95	
	PARTS & ENCLOSURE ONLY	\$132.99	\$4.95	
	PC BOARD & PLANS ONLY	\$30.00	\$1.50	
		GRAND TOTAL	\$	

PLEASE PRINT CLEARLY

SEND THIS ORDER FORM

NAME _____

ADDRESS _____

CITY/STATE/ZIP _____

ORDER DATE _____

MO. DAY YR.

VISA MST. CARD CARD NO. _____

EXP. DATE _____

FOR IMMEDIATE DELIVERY MONEY ORDERS OR CERTIFIED CHECKS PREFERRED PERSONAL CHECKS ALLOW 4 WEEKS FOR DELIVERY

Do Kay Computer Products, Inc.

VISIT OUR RETAIL STORE

3250 KELLER STREET, #9 • SANTA CLARA, CA 95050

EPROMS		STATIC RAMS			
1702	1ns	2.95	450ns	1.80	
2708	450ns	2.98	2102L-2	250nsLP	1.44
2716	450ns	3.25	2111	450ns	2.48
2716-1	350ns	4.69	2114	450ns	1.74
2532	450ns	4.69	2114L-4	450nsLP	1.84
2732	450ns	4.15	2114L-3	300nsLP	1.84
2764	450ns	CALL	2114L-2	200nsLP	1.94
DYNAMIC RAMS		TMS4044-4			
TMS 4027	250ns	.79	450ns	3.15	
UPD 411	300ns	2.89	TMS4044-3	300ns	3.45
MM 5280	300ns	2.89	TMS4044-2	200ns	3.89
MK4108	200ns	1.74	MK4118	250ns	9.69
MM 5298	250ns	1.74	TMM2016	200ns	4.15
4027	250ns	2.00	TMM2016	150ns	4.89
4116	200ns	CALL	HM6116-4	200ns	CALL
4116	150ns	CALL	HM6116-3	150ns	CALL
4164	200ns	CALL	HM6116-2	120ns	CALL
4164	150ns	CALL	Z6132	300ns	32.95

LP = LOW POWER

8000			
3035	4.95	8251	4.39
3039	5.95	8253	6.89
3080A	3.89	8253-5	7.89
3085A	5.89	8255	4.39
3086	24.95	8255-5	5.19
3088	34.95	8257	7.89
3155	7.75	8259	6.85
3156	8.75	8272	39.00
3185	29.00	8275	29.00
3202	27.95	8279	8.89
3205	3.45	8279-5	9.89
3212	1.79	8282	6.49
3214	3.75	8283	6.49
3216	1.69	8284	5.49
3224	2.19	8286	6.49
3226	1.79	8287	6.49
8228	3.34	8288	24.95
8237	19.00	8289	39.00
8238	4.39	8741	34.95
8243	4.39	8748	14.95
8250	10.49	8755	29.95

16K APPLE RAM CARD

Upgrade your 48K Apple II to full 64K

BARE BOARD 14.00
ASSEMBLED & TESTED 42.50

Z80 4.0 MHz

Z80A-CPU 4.90
Z80A-PIO 4.90
Z80A-CTC 4.90

Call for Complete List

MICROPROCESSOR REAL-TIME CLOCK

MSM 5832 6.90

WE WILL BEAT ANY COMPETITOR'S PRICES!

Call before you buy

EPROM ERASERS

HOLDS 15 EPROMS
ERASES IN 20 MINUTES

59.95

6500 1 MHz	
6502	5.25
6504	6.85
6505	7.60
6507	9.85
6520	3.95
6522	4.95
6532	5.95
6545	16.95
6551	10.95

UPGRADE YOUR APPLE OR TRS-80

4116 200ns 8/10.00

CRYSTALS

32.768 KHz	1.90	6.144	2.69
1.00 Hz	4.50	6.5536	2.69
1.8432	4.50	8.0	2.69
2.0	3.90	10.0	2.69
2.097152	3.90	12.0	2.69
2.4576	2.69	14.31818	2.69
3.2768	2.69	15.0	2.69
3.579545	2.69	16.0	2.69
4.0	2.69	17.430	2.69
5.0	2.69	18.0	2.69
5.0688	2.69	18.432	2.69
5.185	2.69	20.0	2.69
5.7143	2.69	22.1184	2.69
6.0	2.69		2.69

74LS00 SERIES

74LS00	.23	74LS123	.49	74LS253	.58
74LS01	.23	74LS124	1.24	74LS257	.58
74LS02	.23	74LS125	.44	74LS258	.58
74LS03	.23	74LS126	.44	74LS259	1.19
74LS04	.23	74LS132	.54	74LS260	.58
74LS05	.23	74LS136	.54	74LS266	.58
74LS08	.23	74LS137	.89	74LS273	1.48
74LS10	.23	74LS138	.49	74LS275	3.20
74LS11	.25	74LS139	.49	74LS279	.48
74LS12	.25	74LS145	1.19	74LS280	1.79
74LS13	.39	74LS147	2.39	74LS283	.68
74LS14	.39	74LS148	1.29	74LS290	.74
74LS15	.29	74LS151	.39	74LS293	.78
74LS20	.23	74LS153	.39	74LS295	.98
74LS21	.23	74LS154	1.89	74LS298	.88
74LS22	.23	74LS155	.59	74LS324	1.74
74LS26	.29	74LS156	.69	74LS352	1.28
74LS27	.23	74LS157	.44	74LS353	1.28
74LS28	.29	74LS158	.49	74LS363	1.34
74LS30	.23	74LS160	.68	74LS364	1.89
74LS32	.25	74LS161	.64	74LS365	.48
74LS33	.49	74LS162	.68	74LS366	.48
74LS37	.29	74LS163	.64	74LS367	.44
74LS38	.29	74LS164	.68	74LS368	.44
74LS40	.23	74LS165	.79	74LS373	.98
74LS42	.43	74LS166	1.69	74LS374	.98
74LS47	.49	74LS168	1.69	74LS377	1.24
74LS48	.74	74LS169	1.74	74LS378	1.15
74LS49	.74	74LS170	1.45	74LS379	1.34
74LS51	.23	74LS173	.68	74LS385	1.89
74LS54	.23	74LS174	.44	74LS386	.44
74LS55	.28	74LS175	.39	74LS390	1.15
74LS63	1.19	74LS181	1.89	74LS393	1.15
74LS73	.34	74LS189	8.79	74LS395	1.15
74LS74	.34	74LS190	.79	74LS399	1.48
74LS75	.34	74LS191	.79	74LS424	.37
74LS76	.34	74LS192	.64	74LS447	.37
74LS78	.45	74LS193	.64	74LS490	1.94
74LS83	.59	74LS194	.68	74LS668	1.69
74LS85	.65	74LS195	.68	74LS669	1.89
74LS86	.35	74LS196	.78	74LS670	1.48
74LS90	.35	74LS197	.78	74LS674	9.45
74LS91	.79	74LS221	.74	74LS682	2.99
74LS92	.54	74LS240	.69	74LS683	2.99
74LS93	.54	74LS251	.69	74LS684	2.99
74LS95	.74	74LS242	.98	74LS685	2.99
74LS96	.69	74LS243	.98	74LS688	2.39
74LS107	.35	74LS244	.79	74LS689	2.99
74LS109	.35	74LS245	1.48		
74LS112	.35	74LS247	.74	81LS95	1.48
74LS113	.35	74LS248	.69	81LS96	1.48
74LS114	.35	74LS249	.69	81LS97	1.48
74LS122	.39	74LS251	.58	81LS98	1.48

DISC CONTROLLERS

1771	15.95
1791	27.95
1793	29.95
1795	49.95
1797	49.95
6843	32.95
8272	39.00
UPD765	34.95
1691	17.95

INTERFACE

8T26	1.65
8T28	1.95
8T95	.95
8T96	.95
8T97	.95
8T98	.95
DM8131	2.90
DP8304	2.25
DS8835	1.89
DS8836	.99

IC SOCKETS

ST	W/W
8 PIN	.49
14 PIN	.50
16 PIN	.57
18 PIN	.85
20 PIN	.99
22 PIN	1.30
24 PIN	1.40
28 PIN	1.50
40 PIN	1.80

ST = Soldertail
W/W = Wirewrap

ORDER TOLL FREE

(800) 538-8800

(800) 848-8008

(CALIFORNIA RESIDENTS)

ALL MERCHANDISE IS 100% GUARANTEED

APPLE SUPER COOLING FANS

49.95
69.95

WITH SURG PROTECH

APPLE PADDLES

9.95

LINEAR

LM301	.32	LM741	.29
LM308	.75	LM747	.75
LM309K	1.25	LM748	.49
LM311	.64	LM1310	2.45
M317T	1.65	MC1330	1.69
LM317K	1.70	MC1350	1.25
LM318	1.49	MC1358	1.69
LM323K	3.75	LM1414	1.49
LM324	.59	LM1458	.55
LM337K	3.90	LM1488	.65
LM339	.79	LM1489	.65
LM377	2.25	LM1800	2.45
LM380	1.25	LM1889	2.45
LM386	1.00	LM3900	.59
LM555	.38	LM3909	.95
LM556	.65	LM3914	3.70
LM565	.95	LM3915	3.70
LM566	1.45	LM3916	3.70
LM567	.99	75451	.35
LM723	.49	75452	.35
LM733	.95	75453	.35

APPLE* II COMPATIBLE DISK DRIVE

225.95
79.95

Do Kay Computer Products, Inc.
3250 Keller Street, #9
Santa Clara, CA 95050
(800) 538-8800
Calif. Residents (800) 848-8008

STORE HOURS:
MON-FRI 8:30 A.M.-5:30 P.M.
SAT 10:00 A.M.-3:00 P.M.



TERMS: For shipping include \$2.00 for UPS Ground. \$3.00 for UPS Blue Label Air. \$10.00 minimum order. Bay Area residents add 6 1/2% Sales Tax. California residents add 6% Sales Tax. We reserve the right to limit quantities and substitute manufacturer. Prices subject to change without notice. Send SASE for complete list.

SCR™

Free Buyers Guide

pages of the latest in components, tools and instruments — a must for DESIGNERS, instructors and maintenance engineers.

COMPUTER KEYBOARDS

An excellent keyboard/w the keys made by a major manufacturer.
54 single pole normally open switches on a single mounting.
Board contains an assortment of 74 LS00 and TTL series IC's, all on a single mounting with PCB edge conn. hook-up.

\$19.95

TELEPHONE HANDSET

This handsome black executive telephone handset comes complete with ear piece and microphone. (Cord not incl.)

\$1.95

RESISTOR BUYOUT

MOST STANDARD VALUES
1/4 WATT 5% RESISTORS 1 OHM TO 10 MEG. OHM
2 K MIN. BUY 1 K MIN. PER VALUE

\$6.50 Per 1,000

UHF/VHF Conversion Kit — with Genuine Mitsumi Tuner.....

\$119.95

CALL OUR HOT LINES
IN CALIF. (714) 527-2554
OUTSIDE CAL. (800) 854-8660

SCR ELECTRONICS CENTER
5303 Lincoln Ave., Cypress, CA 90630

CIRCLE 25 ON FREE INFORMATION CARD

TRS-80 Pure Radio Shack Equipment

COMPUTERS

Buy By Direct Mail

1-800-841-0860

Call For Your Discount Prices

Write For Free Price List

OKIDATA	FRANKLIN
ATARI	EAGLE COMPUTER
SCM SMITH-CORDONA	TRS-80
commodore	EPSON

Micro Management Systems, Inc.
 TELEMARKET DEPT. #15
 2803 Thomasville Road East
 Cairo, Georgia 31728
 (912) 377-7120

CPU'S & SUPPORT CHIPS

8036	4.95
8038	6.95
8038A	2.75
8085A	5.75
8088	18.95
AMD 2901	8.95
8202	19.95
8212	1.80
8214	3.00
8216	1.75
8224	2.25
8228	1.80
8275	3.50
8155	5.50
8156	8.95
8237	14.00
8748	19.95
8755	19.95

SCR's

1.5A	6A	35A	110A
100	.35	.40	1.40
200	.40	.50	1.80
400	.60	.70	2.40
600	1.00	3.60	15.00

TRIAC's

PRV	1A	10A	25A
200	.50	.80	1.90
400	.70	1.00	2.60
600	1.00	1.20	3.60

EPOXY GLASS VECTOR BOARD

1/16" thick with 1/10" spacing
4 1/2" x 6 1/2" \$1.95

14 PIN HEADERS	3/41.00
16 PIN HEADERS	.40
24 PIN HEADERS	.75
40 PIN HEADERS	1.10
50 PIN EDGEBOARD CONN.	3.95
26 PIN EDGEBOARD CONN.	2.50
50 PIN ANGLE CONN.	3.95

SHIFT REGISTERS

MM1402	1.75
MM1403	1.75
MM1404	1.75
MM5013	2.50
MM5055	2.50
MM5056	2.50
MM5057	2.50
MM5060	2.50

C/MOS

4001	25	4043	85	4563	90
4002	25	4044	85	4565	75
4006	65	4046	85	74C00	27
4007	27	4047	95	74C02	27
4009	79	4049	35	74C04	26
4010	46	4051	80	74C10	27
4011	22	4052	75	74C14	35
4012	22	4053	75	74C20	27
4013	36	4050	80	74C22	39
4014	70	4056	39	74C42	100
4015	59	4063	75	74C74	27
4016	30	4068	35	74C78	70
4017	60	4070	35	74C85	140
4018	66	4072	39	74C88	39
4019	39	4071	25	74C90	90
4020	70	4076	85	74C93	50
4021	66	4078	25	74C154	2.50
4022	75	4077	35	74C157	1.75
4023	22	4081	25	74C160	1.20
4024	46	4082	25	74C161	1.15
4025	25	4093	49	74C163	1.15
4026	95	4099	95	74C173	75
4027	40	4501	95	74C174	1.15
4028	55	4510	85	74C176	1.19
4029	35	4514	1.25	74C182	1.30
4030	35	4515	1.50	74C901	39
4034	1.75	4516	75	74C914	1.75
4035	75	4518	75	74C914	1.75
4040	65	4520	70	74C921	3.95
4042	55	4520	70	74C921	3.95
		4528	1.00	74C83	1.25
		4539	1.25		

TRANSISTOR SPECIALS

2N1307 PNP GE TO-18	1.40
2N4004 PNP TO-18	3.11.00
HEP 6014 - PNP GE TO-3	8.95
TIP 111 - 1/2" x 1/4" TIP 145	11.35
2N2833 NPN SWITCHING POWER	7.75
MHF-8004 CM RF TRANSISTOR NPN	11.00
2N3772 NPN SI TO-3	9.10
2N4808 NPN SI TO-3	9.70
TIP 266 PNP SI	1.70
2N2222 NPN SI TO-18	7.11.00
2N2007 NPN SI TO-18	7.11.00
2N3005 NPN SI TO-3	8.80
2N3638 NPN SI TO-3	7.11.00
2N3806 NPN SI TO-3	7.11.00
2N9108 NPN SI TO-220	8.55
TIP 318 NPN SI TO-220	4.40
TIP 328 PNP SI TO-220	4.40
TIP 34 PNP SI	8.95
TIP 121 PNP SI UHF	8.80
TIP 141 NPN SI UHF	11.00
BU205	11.75
DPS2000 - DUAL POWER DIODE	13.95
MJE3055	8.80

DISC CONTROLLERS

MM5307	7.95
BR19M1	8.95
CRT5037	19.95
MM5369	2.50
TR1602B	3.95
PT1472	6.95
AYS-1013A	3.75

NO. 30 WIRE WRAP WIRE SINGLE STRAND

100' \$1.40

CRYSTALS

2.000	6.144
3.000	8.000
3.579	10.000
5.000	18.000
5.000	18.432
6.000	20.000

2.95 ea.

TTL IC SERIES

7400	17	7472	30	74612	60
7401	17	7473	35	74163	60
7402	17	7474	32	74164	60
7403	17	7475	40	74165	60
7404	24	7476	35	74166	70
7405	24	7480	45	74170	1.60
7406	28	7483	50	74173	75
7407	28	7485	55	74174	65
7408	24	7486	35	74175	60
7409	18	7489	1.60	74176	75
7410	17	7490	35	74180	1.90
7411	22	7491	45	74182	45
7412	30	7492	45	74190	70
7413	45	7494	60	74191	75
7414	45	7494	60	74193	79
7416	25	7495	55	74194	85
7417	25	7496	60	74195	45
7420	17	74107	30	74196	75
7425	25	74116	1.50	74221	1.00
7426	25	74121	29	74273	85
7427	25	74122	39	74279	60
7430	17	74132	42	74298	65
7432	27	74136	45	74365	65
7437	27	74145	60	74367	65
7438	27	74148	1.10	74390	90
7440	17	74150	1.10	75324	1.75
7441	75	74151	50	75325	1.50
7442	45	74153	40	75492	1.05
7446	65	74155	50	9602	75
7447	65	74157	50	8126	1.00
7448	65	74160	85	8128	1.25
7450	17	74161	65	8797	90
				8798	90

RAM's

2101A-4	1.50
21L02-3	.70
2114-2	1.40
2114-3	1.00
2147-3	2.50
TMS3409	1.75
MK406P	1.35
MK4027-3	1.75
MK406N1	2.95
MK4096-11	1.25
MK4802	5.95
4116-3	.95
4116-5	1.50
4118A	5.50
5101E	2.95
26104-4	2.50
6116-3	5.50
4164-15	5.50
3242	6.00
TMM2016	5.95

74S SERIES

74S00	.30	74S86	.60	74S163	1.40
74S02	.30	74S89	.90	74S174	1.40
74S03	.30	74S112	.65	74S175	1.40
74S04	.40	74S133	.65	74S182	1.75
74S05	.40	74S135	1.10	74S194	1.10
74S08	.40	74S138	1.25	74S240	1.00
74S10	.30	74S139	1.10	74S241	1.50
74S11	.35	74S140	1.70	74S257	1.30
74S15	.40	74S151	1.25	74S258	1.30
74S20	.40	74S153	.95	74S260	1.50
74S30	.40	74S157	1.25	74S280	1.75
74S32	.40	74S158	1.25	74S373	2.25
74S74	.70	74S161	1.75	74S374	1.75

LINEAR CIRCUITS

DA080EQ	-3.75	LF356	-1.00	747	-50
LM202 CP	-95	LM358	-50	CA758	-1.75
TL064 CN	-1.80	LM361	-1.75	LM1310	-1.60
LM201	-1.50	LM1270	-1.60	1458	-80
LM2011	-75	LM377	-1.60	1458	-80
LM301/748	-30	LM380	-85	LM1808	-1.75
LM307	-30	LM386	-85	LM2001	-95
LM308	-65	LM387	-1.25	CA3018	-1.95
LM310	-1.10	LM393	-75	CA3078AT	-1.50
LM311	-50	LM555	-34	CA3086	-1.75
LM318	-75	LM566	-65	CA3089E	-1.75
LM324	-55	566	-85	AD2000D	-4.95
LM339	-65	566	-1.25	CA3140	-1.00
LM348	-90	567	-85	3900	-45
LF351	-55	709C	-35	4136	-85
LF353	-90	711CH	-40	N5596A	-1.50
LF355	-90	741CV	-40	D6303B	-1.75
				8036CC	-3.90
				LM13080	-95
				8700CJ	-5.95

DISC CAPACITORS

1UF 16V	10/\$1.00	100/\$8.00
01UF 35V	16/\$1.00	100/\$5.00

FULL WAVE BRIDGE

PRV	2A	6A	25A
100	.80	1.30	2.20
200	.80	1.30	2.20
400	1.00	1.65	3.30
600	1.30	1.90	4.40

74LS SERIES

74LS00	.28	74LS109	.45	74LS240	1.10
74LS01	.28	74LS112	.50	74LS241	1.10
74LS02	.33	74LS113	.60	74LS242	1.10
74LS03	.33	74LS114	.65	74LS243	1.10
74LS04	.35	74LS123	.85	74LS244	1.30
74LS05	.38	74LS125	.60	74LS245	1.75
74LS06	.35	74LS126	.60	74LS446	95
74LS08	.35	74LS132	.75	74LS247	90
74LS10	.35	74LS136	.55	74LS248	1.10
74LS11	.35	74LS137	.95	74LS251	70
74LS12	.35	74LS138	.70	74LS253	70
74LS13	.45	74LS139	.70	74LS257	70
74LS14	.50	74LS147	1.95	74LS258	60
74LS15	.50	74LS148	1.10	74LS259	1.00
74LS20	.35	74LS153	.70	74LS266	70
74LS21	.35	74LS154	2.40	74LS273	1.15
74LS22	.35	74LS156	.60	74LS279	60
74LS24	.40	74LS156	.60	74LS280	1.80
74LS27	.40	74LS157	.80	74LS283	80
74LS28	.50	74LS158	.60	74LS290	90
74LS30	.30	74LS160	.90	74LS293	90
74LS32	.40	74LS161	.90	74LS298	90
74LS37	.40	74LS162	.90	74LS320	2.00
74LS38	.40	74LS163	.90	74LS323	3.50
74LS40	.35	74LS164	.90	74LS365	70
74LS42	.55	74LS165	.90	74LS366	70
74LS47	.80	74LS166	1.50	74LS367	70
74LS51	.35	74LS169	2.50	74LS368	70
74LS52	.35	74LS170	1.90	74LS373	1.20
74LS74	.45	74LS173	.90	74LS374	1.20
74LS75	.45	74LS174	.90	74LS377	1.50
74LS76	.45	74LS175	.90	74LS386	60
74LS78	.45	74LS181	1.95	74LS390	1.10
74LS83	.80	74LS180	.90	74LS393	1.10
74LS85					

JAVANGO

YOUR PARTS SUPERMARKET
160 Second Avenue South
Nashville, Tennessee 37201



FPK-7 \$5.75
7 assorted sizes
FP twist-lok can
filter capacitors



6 ea. of 6 assorted useable mylar capacitors
with PC leads in a reuseable plastic box.

THE ULTIMATE SPEAKER



ADO210 SQ8 \$12.50 ea. 2/\$22.50
Philips 8 ohm mid-range
full power speaker

*Ifn yer not
satisfied, we'll
get ya full credit
within 30 days*



9-103-04 \$6.75
Zenith audio module



ADA-1001 \$1.25
6 volt DC wall transformer
in reuseable plastic container
7 ft. cord with 1/8" pin plug.



ECK-50 \$3.75
50 assorted PC and axial lead electrolytics



Fuse Kit 90 \$13.75

Bargains!!!
90 assorted fuses (5 each of 18 types)
3 AG & 5x20 mm sizes
in good useable ampers

Call toll-free 1-800-251-5555 (TN. 1-615-244-4444)
\$15.00 minimum order plus \$2.75 shipping and handling (\$4.75 shipping on COD orders)
Tennessee residents add 6.75% tax Visa and Mastercharge accepted.

CIRCLE 29 ON FREE INFORMATION CARD

**QUALITY
SERVICE
AVAILABILITY**



**ACTIVE, YOUR
NUMBER ONE
CHOICE**

Active Electronics

WE ARE THE LARGEST BECAUSE WE ARE THE BEST.
Over \$40 million in stock. The world's most
complete hobbyist inventory.

Active Electronics is your one stop source for the
widest variety of top quality semiconductors,
microprocessors, memories, microcomputer systems,
peripherals and electronic components.

**NOW
AVAILABLE!
Absolutely
FREE**



**Active's Newly
Revised 1983
Spring/Summer
Catalog**

**Whether you're a serious hobbyist,
experimenter, student or professional
you shouldn't be without it. Call for
your free copy today.**

Circle No. 3 on free information card or write:
P.O. Box 8000, Westboro, Mass. 01581
CALL TOLL FREE: 1-800-343-0874
MASS. customers call (617) 366-0500

CIRCLE 3 ON FREE INFORMATION CARD

CIRCUIT SPECIALISTS

YOUR SEMICONDUCTOR SUPERMARKET

74LS00 SALE

74LS00	.20	74LS123	.50	74LS249	1.25
74LS01	.24	74LS125A	.50	74LS251	.60
74LS02	.24	74LS126A	.50	74LS253	.60
74LS03	.24	74LS132	.80	74LS256	1.50
74LS05	.24	74LS133	.80	74LS257A	.60
74LS08	.24	74LS135	.40	74LS258A	.60
74LS09	.24	74LS137	1.00	74LS259	1.25
74LS10	.24	74LS138	.80	74LS260	.55
74LS11	.24	74LS139	.80	74LS266	.55
74LS12	.24	74LS145	1.30	74LS273	1.25
74LS13	.45	74LS147	1.65	74LS279	.55
74LS14	.60	74LS148	1.65	74LS280	2.25
74LS15	.32	74LS151	.55	74LS283	.90
74LS20	.29	74LS153	.55	74LS290	.80
74LS21	.32	74LS155	.85	74LS293	.90
74LS22	.32	74LS156	.80	74LS295A	.95
74LS26	.32	74LS157	.80	74LS298	.90
74LS27	.32	74LS158	.80	74LS299	2.60
74LS28	.32	74LS160A	.85	74LS322A	4.60
74LS28	.32	74LS161	.85	74LS323	4.60
74LS30	.32	74LS162	.80	74LS348	1.75
74LS32	.32	74LS163A	.80	74LS352	1.25
74LS33	.32	74LS164	.80	74LS353	1.25
74LS37	.40	74LS165	1.25	74LS365A	.55
74LS40	.35	74LS166	1.25	74LS366A	.55
74LS42	.60	74LS168	1.25	74LS367A	.55
74LS47	.89	74LS169	1.25	74LS368A	.55
74LS48	1.00	74LS170	1.75	74LS373	1.35
74LS49	1.00	74LS173	.80	74LS374	1.25
74LS51	.29	74LS174	.55	74LS375	.55
74LS54	.29	74LS175	.60	74LS377	1.25
74LS55	.29	74LS181	2.25	74LS378	1.25
74LS73A	.42	74LS182	1.25	74LS379	1.25
74LS74A	.42	74LS183	2.75	74LS385	3.50
74LS75	.45	74LS190	.85	74LS386	.55
74LS76A	.45	74LS191	.85	74LS390	1.25
74LS77	.70	74LS192	.85	74LS393	1.25
74LS78A	.49	74LS193	.85	74LS395	1.25
74LS83A	.75	74LS194A	.80	74LS398	2.25
74LS85	.90	74LS195A	.80	74LS399	1.25
74LS86	.45	74LS196	1.00	74LS490	2.10
74LS90	.45	74LS197	1.00	74LS540	2.10
74LS91	1.10	74LS221	1.25	74LS541	2.10
74LS92	.55	74LS240	1.25	74LS568	3.99
74LS93	.55	74LS241	1.25	74LS569	3.99
74LS95B	.65	74LS242	1.25	74LS620	2.00
74LS107A	.45	74LS243	1.25	74LS621	2.00
74LS109A	.45	74LS244	1.25	74LS622	2.00
74LS112A	.45	74LS245	1.75	74LS623	2.00
74LS113A	.45	74LS247	1.25	74LS640	2.00
74LS114A	.60	74LS248	1.25		
74LS122	.80				

7400

7400	.20	7475	.50
7401	.29	7476	.38
7402	.29	7485	1.10
7403	.29	7486	.35
7404	.31	7489	2.40
7405	.32	7490	.52
7406	.38	7492	.52
7408	.31	7493	.52
7410	.30	7495	.67
7411	.31	7496	.73
7413	.46	74107	.35
7414	.59	74121	.40
7417	.32	74123	.58
7420	.29	74125	.52
7425	.31	74145	.75
7427	.32	74147	1.67
7430	.30	74151	.75
7432	.31	74153	.75
7437	.31	74154	1.17
7438	.31	74157	.75
7440	.29	74164	1.05
7441	1.00	74165	1.05
7442	.60	74174	1.00
7446	.83	74175	.83
7447	.83	74176	.80
7448	.83	74177	.80
7450	.29	74190	1.08
7472	.35	74192	.99
7473	.35	74193	.99
7474	.35	74196	.80

VOLT-REGS

7805	.80	LM317T	1.00
7806	.80	LM317K	3.75
7808	.80	LM323K	6.95
7812	.80	LM350T	3.25
7815	.80	LM350K	5.50
7818	.80	LM338K	7.60
7824	.80	LM337T	1.90
7905	1.30	78L05	.40
7906	1.30	78L12	.40
7908	1.30	78L15	.40
7912	1.30	79L05	.80
7915	1.30	79L12	.80
7918	1.30	79L15	.80
7924	1.30	78H05KC	9.25
		78H12KC	9.25

LINEAR IC'S

LM301AN	.48	LM3900	.75	MC1489P	1.10
LM307N	.56	LM3909	1.00	MC1496P	1.48
LM308N	.71	LM3911	1.50	MC1723P	.82
LM310N	2.40	LF347	.60	MC1741CP1	.56
LM311N	.69	LF351	.60	MC3301	.90
LM318N	2.50	LF353	.99	MC3302	.80
LM319N	2.40	LF357	1.10	MC3401	.90
LM324N	.71	NE555	.42	MC3403P	1.30
LM325N	3.30	MC1306P	1.10	MC1648P	3.80
LM326N	3.30	MC1310	4.29	MC1658P	4.50
LM556N	.93	MC1330A1P	1.50	MC4024P	4.49
LM339N	.69	MC1349P	1.17	MC4044P	4.49
LM383T	2.30	MC1350P	.98	ICM7208	15.95
LM377N	2.40	MC1351P	1.70	ICM7207A	6.00
LM378N	3.15	MC1357P	1.49	ICM7217A	9.95
LM379N	4.60	MC1358P	1.30	ICM7205	12.95
LM380N	.90	MC1372P	4.42	ICM7045	15.50
LM381N	2.25	MC1373P	3.54	ICL8038	3.40
LM381AN	3.60	MC1403U	2.71	ICM7555	1.20
LM384N	2.00	MC1405L	9.70	MWA110	7.45
LM386N	.99	MC1413P	1.20	MWA120	7.80
LM565N	1.35	MC1374P	2.61	MWA130	8.25
LM566N	2.30	MC1376P	2.08	MWA310	8.25
LM567N	1.35	MC1458CP1	.77	MWA320	8.65
LM1889	3.20	MC1488P	1.10	ZN414	2.00

CMOS

CD4001	.30	CD4046	1.50	MC14000	.40	MC14023	1.22
CD4007	.32	CD4047	1.40	MC14001	.40	MC14024	1.06
CD4010	.55	CD4049	.45	MC14002	.40	MC14024	.40
CD4011	.32	CD4050	.45	MC14006	1.42	MC14027	.72
CD4013	.45	CD4051	1.00	MC14007	.40	MC14028	1.02
CD4016	.50	CD4066	.65	MC14008	1.25	MC14032	1.93
CD4017	1.00	CD4069	.32	MC14012	.40	MC14034	3.50
CD4020	1.17	CD4070	.45	MC14013	.72	MC14035	1.86
CD4023	.32	CD4071	.32	MC14014	1.25	MC14038	2.19
CD4024	.83	CD4081	.32	MC14015	1.47	MC14040	1.47
CD4025	.32	CD4093	.60	MC14016	.72	MC14042	1.06
CD4027	.55	CD4510	1.17	MC14017	1.25	MC14043	.99
CD4029	1.42	CD4511	1.20	MC14018	1.15	MC14044	.99
CD4040	1.17	CD4515	2.80	MC14020	1.47	MC14046	1.57
CD4044	.80	CD4518	1.17	MC14021	1.25	MC14049	.72

MOST MOTOROLA CMOS IN STOCK

CIRCUIT SPECIALISTS INC.
BOX 3047, SCOTTSDALE, AZ 85257
(602) 966-0764
INCLUDE \$1.25 SHIPPING

Govt. SURPLUS ELECTRONIC EQUIPMENT CATALOG

New ITEMS. . . New BARGAINS!

FREE UPON REQUEST!

Send today for FREE copy of
NEW CATALOG 83 • Address: Dept. RE

FAIR RADIO SALES
1016 E. EUREKA • Box 1105 • LIMA, OHIO • 45802

**"WITH DIRECT DEPOSIT
WE CAN
JUST PICK UP
AND GO!"**

Just ask for Direct Deposit whenever you have a checking or savings account. It's free, and it's something you deserve just as much as what you've waited a lifetime for.

DIRECT DEPOSIT
YOU'VE GOT IT COMING.

FUJITECH AUDIO KITS

LATEST AUDIO TECHNOLOGY
FROM JAPAN

Model A501 Power Amp

- Pure Class A 25W + 25W
- Switchable to Class AB 100W + 100W
- Switchable to Bridge Class A 100W mono
- Switchable to Bridge Class AB 300W mono
- Frequency Response 5-200KHz (-1dB)
- Signal-to-Noise Ratio 120dB
- Non-magnetic Chassis
- "Out-board" comprehensive protection circuitry
- DC circuitry with limited use of NFB
- High Efficiency Fluid Convection Cooling
- THD under 0.007%

KIT ONLY
\$299.00



\$299.00

Model A502 DC Stereo Control Center

- Direct DC coupling from Input to Output
- DC servo circuitry
- Cascade FET Input in all stages
- Separate Moving Coil RIAA amplifier
- Distortion below 0.005% (3V)
- Max Output 15V
- Frequency Response 20Hz-20KHz ±0.2 dB
- Maximum Phono Input
MC = 16mv RMS (1KHz)
MM = 270mv RMS (1KHz)
- Built-in Headphone amplifier
- Relay Output Muting

KIT ONLY
\$349.00



\$349.00

Model A1033 Integrated Tube Amplifier

- Latest Japanese Design
- Distortionless Output Transformer using special winding techniques
- Most circuitry on PCB for easy assembly and humfree performance
- Output 30W × 2 Ultra Linear
(Switchable to Triode)
15W × 2 Triode Output
(near class A performance)
- THD under 0.4%
- Frequency Response 30~30,000 Hz (-1dB)
- Separate Pre-Out and Main-In

KIT ONLY
\$499.00

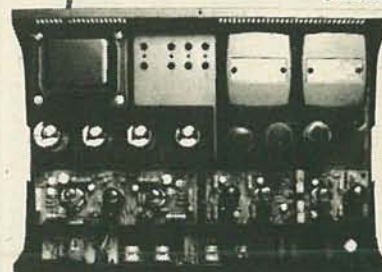

\$499.00

Send \$5.00 for each assembly manual, refundable with order.

Monarchy Engineering, Inc.
380 Swift Avenue, Unit 21
South San Francisco, CA 94080

Visa or Mastercharge acceptable.

COMING SOON

1983 FALL/WINTER
SERVICEMAN'S CATALOG



YOUR COMPLETE ELECTRONIC PARTS SOURCE!

MOST ORDERS SHIPPED WITHIN 24 HOURS.
CALL OR WRITE FOR YOUR FREE CATALOGUE.
COMPARE OUR LOW PRICES AND SAVE!

CE Consolidated Electronics,
Incorporated

705 WATERLIET AVE., DAYTON, OHIO 45420
IN DAYTON, (513) 252-5662

TELEX NO. 288-229

**CALL TOLL
FREE TODAY!**

1-800-543-3568

1-800-762-3412

NATIONAL WATS

OHIO WATS

CIRCLE 18 ON FREE INFORMATION CARD

ramsey

the first name in Counters!



9 DIGITS 600 MHz \$129⁹⁵ WIRED

PRICES:

CT-90 wired, 1 year warranty	\$129.95
CT-90 Kit, 90 day parts warranty	109.95
AC-1 AC adapter	3.95
BP-1 Nicad pack + AC Adapter/Charger	12.95
OV-1, Micro-power Oven time base	49.95
External time base input	14.95

The CT-90 is the most versatile, feature packed counter available for less than \$300.00! Advanced design features include: three selectable gate times, nine digits, gate indicator and a unique display hold function which holds the displayed count after the input signal is removed! Also, a 10MHz TCXO time base is used which enables easy zero beat calibration checks against WWV. Optionally, an internal nicad battery pack, external time base input and Micro-power high stability crystal oven time base are available. The CT-90, performance you can count on!

SPECIFICATIONS:

Range:	20 Hz to 600 MHz
Sensitivity:	Less than 10 MV to 150 MHz Less than 50 MV to 500 MHz
Resolution:	0.1 Hz (10 MHz range) 1.0 Hz (60 MHz range) 10.0 Hz (600 MHz range)
Display:	9 digits 0.4" LED
Time base:	Standard-10.000 mHz, 1.0 ppm 20-40°C Optional Micro-power oven-0.1 ppm 20-40°C
Power:	8-15 VAC @ 250 ma

7 DIGITS 525 MHz \$99⁹⁵ WIRED



SPECIFICATIONS:

Range:	20 Hz to 525 MHz
Sensitivity:	Less than 50 MV to 150 MHz Less than 150 MV to 500 MHz
Resolution:	1.0 Hz (5 MHz range) 10.0 Hz (50 MHz range) 100.0 Hz (500 MHz range)
Display:	7 digits 0.4" LED
Time base:	1.0 ppm TCXO 20-40°C
Power:	12 VAC @ 250 ma

The CT-70 breaks the price barrier on lab quality frequency counters. Deluxe features such as, three frequency ranges - each with pre-amplification, dual selectable gate times, and gate activity indication make measurements a snap. The wide frequency range enables you to accurately measure signals from audio thru UHF with 1.0 ppm accuracy - that's .0001%! The CT-70 is the answer to all your measurement needs, in the field, lab or ham shack.

PRICES:

CT-70 wired, 1 year warranty	\$99.95
CT-70 Kit, 90 day parts warranty	84.95
AC-1 AC adapter	3.95
BP-1 Nicad pack + AC adapter/charger	12.95

7 DIGITS 500 MHz \$79⁹⁵ WIRED



PRICES:

MINI-100 wired, 1 year warranty	\$79.95
AC-Z Ac adapter for MINI-100	3.95
BP-Z Nicad pack and AC adapter/charger	12.95

Here's a handy, general purpose counter that provides most counter functions at an unbelievable price. The MINI-100 doesn't have the full frequency range or input impedance qualities found in higher price units, but for basic RF signal measurements, it can't be beat! Accurate measurements can be made from 1 MHz all the way up to 500 MHz with excellent sensitivity throughout the range, and the two gate times let you select the resolution desired. Add the nicad pack option and the MINI-100 makes an ideal addition to your tool box for "in-the-field" frequency checks and repairs.

SPECIFICATIONS:

Range:	1 MHz to 500 MHz
Sensitivity:	Less than 25 MV
Resolution:	100 Hz (slow gate) 1.0 KHz (fast gate)
Display:	7 digits, 0.4" LED
Time base:	2.0 ppm 20-40°C
Power:	5 VDC @ 200 ma

8 DIGITS 600 MHz \$159⁹⁵ WIRED



SPECIFICATIONS:

Range:	20 Hz to 600 MHz
Sensitivity:	Less than 25 mv to 150 MHz Less than 150 mv to 600 MHz
Resolution:	1.0 Hz (60 MHz range) 10.0 Hz (600 MHz range)
Display:	8 digits 0.4" LED
Time base:	2.0 ppm 20-40°C
Power:	110 VAC or 12 VDC

The CT-50 is a versatile lab bench counter that will measure up to 600 MHz with 8 digit precision. And, one of its best features is the Receive Frequency Adapter, which turns the CT-50 into a digital readout for any receiver. The adapter is easily programmed for any receiver and a simple connection to the receiver's VFO is all that is required for use. Adding the receiver adapter in no way limits the operation of the CT-50, the adapter can be conveniently switched on or off. The CT-50, a counter that can work double-duty!

PRICES:

CT-50 wired, 1 year warranty	\$159.95
CT-50 Kit, 90 day parts warranty	119.95
RA-1, receiver adapter kit	14.95
RA-1 wired and pre-programmed (send copy of receiver schematic)	29.95



DIGITAL MULTIMETER \$99⁹⁵ WIRED

PRICES:

DM-700 wired, 1 year warranty	\$99.95
DM-700 Kit, 90 day parts warranty	79.95
AC-1, AC adaptor	3.95
BP-3, Nicad pack + AC adapter/charger	19.95
MP-1, Probe kit	2.95

The DM-700 offers professional quality performance at a hobbyist price. Features include: 26 different ranges and 5 functions, all arranged in a convenient, easy to use format. Measurements are displayed on a large 3 1/2 digit, 1/2 inch LED readout with automatic decimal placement, automatic polarity, overrange indication and overload protection up to 1250 volts on all ranges, making it virtually goof-proof! The DM-700 looks great, a handsome, jet black, rugged ABS case with convenient retractable tilt bail makes it an ideal addition to any shop.

SPECIFICATIONS:

DC/AC volts:	100uV to 1 KV, 5 ranges
DC/AC current:	0.1uA to 2.0 Amps, 5 ranges
Resistance:	0.1 ohms to 20 Megohms, 6 ranges
Input impedance:	10 Megohms, DC/AC volts
Accuracy:	0.1% basic DC volts
Power:	4 'C' cells

AUDIO SCALER

For high resolution audio measurements, multiplies UP in frequency.

- Great for PL tones
- Multiplies by 10 or 100
- 0.01 Hz resolution!

\$29.95 Kit \$39.95 Wired

ACCESSORIES

Telescopic whip antenna - BNC plug	\$ 7.95
High impedance probe, light loading	15.95
Low pass probe, for audio measurements	15.95
Direct probe, general purpose usage	12.95
Tilt bail, for CT 70, 90, MINI-100	3.95
Color burst calibration unit, calibrates counter against color TV signal	14.95

COUNTER PREAMP

For measuring extremely weak signals from 10 to 1,000 MHz. Small size, powered by plug transformer-included.

- Flat 25 db gain
- BNC Connectors
- Great for sniffing RF with pick-up loop

\$34.95 Kit \$44.95 Wired

ramsey electronics, inc.
2575 BAIRD RD. • PENFIELD, NY 14526

PHONE ORDERS
CALL 716-586-3950

TERMS Satisfaction guaranteed - examine for 10 days, if not pleased, return in original form for refund. Add 5% for shipping - insurance to a maximum of \$10. Overseas add 15%. COD, add \$2. Orders under \$10, add \$1.50. NY residents, add 7% tax.

CIRCLE 79 ON FREE INFORMATION CARD

AUGUST 1983

IGI ELECTRONICS CORPORATION

In Mn., Ak., Hi. Call 218-681-6674

QUALITY - Name brand products from nationally recognized manufacturers. **SERVICE** - Computerized order processing and inventory control. **SAVINGS** - Volume Discounts • DEM Quantity Pricing • Toll Free 800 Number

INTEGRATED CIRCUITS

Part No.	Price	Part No.	Price	Part No.	Price	Part No.	Price
7400 TTL	39	7410 TTL	39	7420 TTL	39	7430 TTL	39
7401 TTL	39	7411 TTL	39	7421 TTL	39	7431 TTL	39
7402 TTL	39	7412 TTL	39	7422 TTL	39	7432 TTL	39
7403 TTL	39	7413 TTL	39	7423 TTL	39	7433 TTL	39
7404 TTL	39	7414 TTL	39	7424 TTL	39	7434 TTL	39
7405 TTL	39	7415 TTL	39	7425 TTL	39	7435 TTL	39
7406 TTL	39	7416 TTL	39	7426 TTL	39	7436 TTL	39
7407 TTL	39	7417 TTL	39	7427 TTL	39	7437 TTL	39
7408 TTL	39	7418 TTL	39	7428 TTL	39	7438 TTL	39
7409 TTL	39	7419 TTL	39	7429 TTL	39	7439 TTL	39
7410 TTL	39	7420 TTL	39	7430 TTL	39		
7411 TTL	39	7430 TTL	39				
7412 TTL	39						
7413 TTL	39						
7414 TTL	39						
7415 TTL	39						
7416 TTL	39						
7417 TTL	39						
7418 TTL	39						
7419 TTL	39						
7420 TTL	39						
7421 TTL	39						
7422 TTL	39						
7423 TTL	39						
7424 TTL	39						
7425 TTL	39						
7426 TTL	39						
7427 TTL	39						
7428 TTL	39						
7429 TTL	39						
7430 TTL	39						
7431 TTL	39						
7432 TTL	39						
7433 TTL	39						
7434 TTL	39						
7435 TTL	39						
7436 TTL	39						
7437 TTL	39						
7438 TTL	39						
7439 TTL	39						
7440 TTL	39						

INTEGRATED CIRCUITS

Part No.	Price	Part No.	Price	Part No.	Price	Part No.	Price
4000 CMOS	39	4001 CMOS	39	4002 CMOS	39	4003 CMOS	39
4004 CMOS	39	4005 CMOS	39	4006 CMOS	39	4007 CMOS	39
4008 CMOS	39	4009 CMOS	39	4010 CMOS	39	4011 CMOS	39
4012 CMOS	39	4013 CMOS	39	4014 CMOS	39	4015 CMOS	39
4016 CMOS	39	4017 CMOS	39	4018 CMOS	39	4019 CMOS	39
4020 CMOS	39	4021 CMOS	39	4022 CMOS	39	4023 CMOS	39
4024 CMOS	39	4025 CMOS	39	4026 CMOS	39	4027 CMOS	39
4028 CMOS	39	4029 CMOS	39	4030 CMOS	39	4031 CMOS	39
4032 CMOS	39	4033 CMOS	39	4034 CMOS	39	4035 CMOS	39
4036 CMOS	39	4037 CMOS	39	4038 CMOS	39	4039 CMOS	39
4040 CMOS	39	4041 CMOS	39	4042 CMOS	39	4043 CMOS	39
4044 CMOS	39	4045 CMOS	39	4046 CMOS	39	4047 CMOS	39
4048 CMOS	39	4049 CMOS	39	4050 CMOS	39	4051 CMOS	39
4052 CMOS	39	4053 CMOS	39	4054 CMOS	39	4055 CMOS	39
4056 CMOS	39	4057 CMOS	39	4058 CMOS	39	4059 CMOS	39
4060 CMOS	39	4061 CMOS	39	4062 CMOS	39	4063 CMOS	39
4064 CMOS	39	4065 CMOS	39	4066 CMOS	39	4067 CMOS	39
4070 CMOS	39	4071 CMOS	39	4072 CMOS	39	4073 CMOS	39
4074 CMOS	39	4075 CMOS	39	4076 CMOS	39	4077 CMOS	39
4080 CMOS	39	4081 CMOS	39	4082 CMOS	39	4083 CMOS	39
4084 CMOS	39	4085 CMOS	39	4086 CMOS	39	4087 CMOS	39
4090 CMOS	39	4091 CMOS	39	4092 CMOS	39	4093 CMOS	39
4094 CMOS	39	4095 CMOS	39	4096 CMOS	39	4097 CMOS	39
4100 CMOS	39	4101 CMOS	39	4102 CMOS	39	4103 CMOS	39
4104 CMOS	39	4105 CMOS	39	4106 CMOS	39	4107 CMOS	39
4110 CMOS	39	4111 CMOS	39	4112 CMOS	39	4113 CMOS	39
4114 CMOS	39	4115 CMOS	39	4116 CMOS	39	4117 CMOS	39
4120 CMOS	39	4121 CMOS	39	4122 CMOS	39	4123 CMOS	39
4124 CMOS	39	4125 CMOS	39	4126 CMOS	39	4127 CMOS	39
4130 CMOS	39	4131 CMOS	39	4132 CMOS	39	4133 CMOS	39
4134 CMOS	39	4135 CMOS	39	4136 CMOS	39	4137 CMOS	39
4140 CMOS	39	4141 CMOS	39	4142 CMOS	39	4143 CMOS	39
4144 CMOS	39	4145 CMOS	39	4146 CMOS	39	4147 CMOS	39
4150 CMOS	39	4151 CMOS	39	4152 CMOS	39	4153 CMOS	39
4154 CMOS	39	4155 CMOS	39	4156 CMOS	39	4157 CMOS	39
4160 CMOS	39	4161 CMOS	39	4162 CMOS	39	4163 CMOS	39
4164 CMOS	39	4165 CMOS	39	4166 CMOS	39	4167 CMOS	39
4170 CMOS	39	4171 CMOS	39	4172 CMOS	39	4173 CMOS	39
4174 CMOS	39	4175 CMOS	39	4176 CMOS	39	4177 CMOS	39
4180 CMOS	39	4181 CMOS	39	4182 CMOS	39	4183 CMOS	39
4184 CMOS	39	4185 CMOS	39	4186 CMOS	39	4187 CMOS	39
4190 CMOS	39	4191 CMOS	39	4192 CMOS	39	4193 CMOS	39
4194 CMOS	39	4195 CMOS	39	4196 CMOS	39	4197 CMOS	39
4200 CMOS	39	4201 CMOS	39	4202 CMOS	39	4203 CMOS	39
4204 CMOS	39	4205 CMOS	39	4206 CMOS	39	4207 CMOS	39
4210 CMOS	39	4211 CMOS	39	4212 CMOS	39	4213 CMOS	39
4214 CMOS	39	4215 CMOS	39	4216 CMOS	39	4217 CMOS	39
4220 CMOS	39	4221 CMOS	39	4222 CMOS	39	4223 CMOS	39
4224 CMOS	39	4225 CMOS	39	4226 CMOS	39	4227 CMOS	39
4230 CMOS	39	4231 CMOS	39	4232 CMOS	39	4233 CMOS	39
4234 CMOS	39	4235 CMOS	39	4236 CMOS	39	4237 CMOS	39
4240 CMOS	39	4241 CMOS	39	4242 CMOS	39	4243 CMOS	39
4244 CMOS	39	4245 CMOS	39	4246 CMOS	39	4247 CMOS	39
4250 CMOS	39	4251 CMOS	39	4252 CMOS	39	4253 CMOS	39
4254 CMOS	39	4255 CMOS	39	4256 CMOS	39	4257 CMOS	39
4260 CMOS	39	4261 CMOS	39	4262 CMOS	39	4263 CMOS	39
4264 CMOS	39	4265 CMOS	39	4266 CMOS	39	4267 CMOS	39
4270 CMOS	39	4271 CMOS	39	4272 CMOS	39	4273 CMOS	39
4274 CMOS	39	4275 CMOS	39	4276 CMOS	39	4277 CMOS	39
4280 CMOS	39	4281 CMOS	39	4282 CMOS	39	4283 CMOS	39
4284 CMOS	39	4285 CMOS	39	4286 CMOS	39	4287 CMOS	39
4290 CMOS	39	4291 CMOS	39	4292 CMOS	39	4293 CMOS	39
4294 CMOS	39	4295 CMOS	39	4296 CMOS	39	4297 CMOS	39
4300 CMOS	39	4301 CMOS	39	4302 CMOS	39	4303 CMOS	39
4304 CMOS	39	4305 CMOS	39	4306 CMOS	39	4307 CMOS	39
4310 CMOS	39	4311 CMOS	39	4312 CMOS	39	4313 CMOS	39
4314 CMOS	39	4315 CMOS	39	4316 CMOS	39	4317 CMOS	39
4320 CMOS	39	4321 CMOS	39	4322 CMOS	39	4323 CMOS	39
4324 CMOS	39	4325 CMOS	39	4326 CMOS	39	4327 CMOS	39
4330 CMOS	39	4331 CMOS	39	4332 CMOS	39	4333 CMOS	39
4334 CMOS	39	4335 CMOS	39	4336 CMOS	39	4337 CMOS	39
4340 CMOS	39	4341 CMOS	39	4342 CMOS	39	4343 CMOS	39
4344 CMOS	39	4345 CMOS	39	4346 CMOS	39	4347 CMOS	39
4350 CMOS	39	4351 CMOS	39	4352 CMOS	39	4353 CMOS	39
4354 CMOS	39	4355 CMOS	39	4356 CMOS	39	4357 CMOS	39
4360 CMOS	39	4361 CMOS	39	4362 CMOS	39	4363 CMOS	39
4364 CMOS	39	4365 CMOS	39	4366 CMOS	39	4367 CMOS	39
4370 CMOS	39	4371 CMOS	39	4372 CMOS	39	4373 CMOS	39
4374 CMOS	39	4375 CMOS	39	4376 CMOS	39	4377 CMOS	39
4380 CMOS	39	4381 CMOS	39	4382 CMOS	39	4383 CMOS	39
4384 CMOS	39	4385 CMOS	39	4386 CMOS	39	4387 CMOS	39
4390 CMOS	39	4391 CMOS	39	4392 CMOS	39	4393 CMOS	39
4394 CMOS	39	4395 CMOS	39	4396 CMOS	39	4397 CMOS	39
4400 CMOS	39	4401 CMOS	39	4402 CMOS	39	4403 CMOS	39
4404 CMOS	39	4405 CMOS	39	4406 CMOS	39	4407 CMOS	39
4410 CMOS	39	4411 CMOS	39	4412 CMOS	39	4413 CMOS	39
4414 CMOS	39	4415 CMOS	39	4416 CMOS	39	4417 CMOS	39
4420 CMOS	39	4421 CMOS	39	4422 CMOS	39	4423 CMOS	39
4424 CMOS	39	4425 CMOS	39	4426 CMOS	39	4427 CMOS	39
4430 CMOS	39	4431 CMOS	39	4432 CMOS	39	4433 CMOS	39
4434 CMOS	39	4435 CMOS	39	4436 CMOS	39	4437 CMOS	39
4440 CMOS	39	4441 CMOS	39	4442 CMOS	39	4443 CMOS	39
4444 CMOS	39	4445 CMOS	39	4446 CMOS	39	4447 CMOS	39
4450 CMOS	39	4451 CMOS	39	4452 CMOS	39	4453 CMOS	39
4454 CMOS	39	4455 CMOS	39	4456 CMOS	39	4457 CMOS	39
4460 CMOS	39	4461 CMOS	39	4462 CMOS	39	4463 CMOS	39
4464 CMOS	39	4465 CMOS	39	4466 CMOS	39	4467 CMOS	39
4470 CMOS	39	4471 CMOS	39	4472 CMOS	39	4473 CMOS	39
4474 CMOS	39	4475 CMOS	39	4476 CMOS	39	4477 CMOS	39
4480 CMOS	39	4481 CMOS	39	4482 CMOS	39	4483 CMOS	39
4484 CMOS	39	4485 CMOS	39	4486 CMOS	39	4487 CMOS	39
4490 CMOS	39	4491 CMOS	39	4492 CMOS	39	4493 CMOS	39
4494 CMOS	39	4495 CMOS	39	4496 CMOS	39	4497 CMOS	39
4500 CMOS	39	4501 CMOS	39	4502 CMOS	39	4503 CMOS	39
4504 CMOS	39	4505 CMOS	39	4506 CMOS	39	4507 CMOS	39
4510 CMOS	39	4511 CMOS	39	4512 CMOS	39	4513 CMOS	39
4514 CMOS	39	4515 CMOS	39	4516 CMOS	39	4517 CMOS	39
4520 CMOS	39	4521 CMOS	39	4522 CMOS	39	4523 CMOS	39
4524 CMOS	39	4525 CMOS	39	4526 CMOS	39	4527 CMOS	39
4530 CMOS	39	4531 CMOS	39	4532 CMOS	39	4533 CMOS	39
4534 CMOS	39	4535 CMOS	39	4536 CMOS	39	4537 CMOS	39
4540 CMOS	39	4541 CMOS	39	4542 CMOS	39		

DIGI-KEY CORPORATION

In Mn., Ak., Hi. Call 218-681-6674

NATIONAL SEMICONDUCTOR • QUALITY - Name brand products from nationally recognized manufacturers.
SERVICE - Computerized order processing and inventory control.
SAVINGS - Volume Discounts • OEM Quantity Pricing • Toll Free 800 Number
 The Big DIGI-KEY Discount makes a Big Price Difference

VISA SILICON RECTIFIERS

3 AMP ZENER DIODES

IT RECTIFIERS

Part No.	Description	Price
1N4001	1N4001 50V 1.0A	0.10
1N4002	1N4002 60V 1.0A	0.10
1N4003	1N4003 70V 1.0A	0.10
1N4004	1N4004 80V 1.0A	0.10
1N4005	1N4005 90V 1.0A	0.10
1N4006	1N4006 100V 1.0A	0.10
1N4007	1N4007 110V 1.0A	0.10
1N4008	1N4008 120V 1.0A	0.10
1N4009	1N4009 130V 1.0A	0.10
1N4010	1N4010 150V 1.0A	0.10

National Semiconductor

MA1026 Time-Temp. Clock Module

• 6" and 8" and virtually any number of times
 • 50 Hz line frequency operation
 • 12 or 24 Hour display

Typical Applications include:
 Clock • Time • Alarm Clock • Desk Clock • TV and Stereo • Timer • Industrial Panel Clock • Digital Transmitter and much more...

Part No.	Description	Price
MA1026	MA1026 clock module only	62.79
MA1027	Digi-Key switch panel for P.C.	11.99
MA1028	Time-Temp. Clock Module	74.78
MA1029	Time-Temp. Clock Module	74.78
MA1030	Time-Temp. Clock Module	74.78
MA1031	Time-Temp. Clock Module	74.78
MA1032	Time-Temp. Clock Module	74.78
MA1033	Time-Temp. Clock Module	74.78
MA1034	Time-Temp. Clock Module	74.78
MA1035	Time-Temp. Clock Module	74.78
MA1036	Time-Temp. Clock Module	74.78
MA1037	Time-Temp. Clock Module	74.78
MA1038	Time-Temp. Clock Module	74.78
MA1039	Time-Temp. Clock Module	74.78
MA1040	Time-Temp. Clock Module	74.78
MA1041	Time-Temp. Clock Module	74.78
MA1042	Time-Temp. Clock Module	74.78
MA1043	Time-Temp. Clock Module	74.78
MA1044	Time-Temp. Clock Module	74.78
MA1045	Time-Temp. Clock Module	74.78
MA1046	Time-Temp. Clock Module	74.78
MA1047	Time-Temp. Clock Module	74.78
MA1048	Time-Temp. Clock Module	74.78
MA1049	Time-Temp. Clock Module	74.78
MA1050	Time-Temp. Clock Module	74.78

Silicon Transistors

Part No.	Description	Price
2N3638	2N3638 100V 1.0A	0.10
2N3639	2N3639 100V 1.0A	0.10
2N3640	2N3640 100V 1.0A	0.10
2N3641	2N3641 100V 1.0A	0.10
2N3642	2N3642 100V 1.0A	0.10
2N3643	2N3643 100V 1.0A	0.10
2N3644	2N3644 100V 1.0A	0.10
2N3645	2N3645 100V 1.0A	0.10
2N3646	2N3646 100V 1.0A	0.10
2N3647	2N3647 100V 1.0A	0.10
2N3648	2N3648 100V 1.0A	0.10
2N3649	2N3649 100V 1.0A	0.10
2N3650	2N3650 100V 1.0A	0.10
2N3651	2N3651 100V 1.0A	0.10
2N3652	2N3652 100V 1.0A	0.10
2N3653	2N3653 100V 1.0A	0.10
2N3654	2N3654 100V 1.0A	0.10
2N3655	2N3655 100V 1.0A	0.10
2N3656	2N3656 100V 1.0A	0.10
2N3657	2N3657 100V 1.0A	0.10
2N3658	2N3658 100V 1.0A	0.10
2N3659	2N3659 100V 1.0A	0.10
2N3660	2N3660 100V 1.0A	0.10
2N3661	2N3661 100V 1.0A	0.10
2N3662	2N3662 100V 1.0A	0.10
2N3663	2N3663 100V 1.0A	0.10
2N3664	2N3664 100V 1.0A	0.10
2N3665	2N3665 100V 1.0A	0.10
2N3666	2N3666 100V 1.0A	0.10
2N3667	2N3667 100V 1.0A	0.10
2N3668	2N3668 100V 1.0A	0.10
2N3669	2N3669 100V 1.0A	0.10
2N3670	2N3670 100V 1.0A	0.10
2N3671	2N3671 100V 1.0A	0.10
2N3672	2N3672 100V 1.0A	0.10
2N3673	2N3673 100V 1.0A	0.10
2N3674	2N3674 100V 1.0A	0.10
2N3675	2N3675 100V 1.0A	0.10
2N3676	2N3676 100V 1.0A	0.10
2N3677	2N3677 100V 1.0A	0.10
2N3678	2N3678 100V 1.0A	0.10
2N3679	2N3679 100V 1.0A	0.10
2N3680	2N3680 100V 1.0A	0.10
2N3681	2N3681 100V 1.0A	0.10
2N3682	2N3682 100V 1.0A	0.10
2N3683	2N3683 100V 1.0A	0.10
2N3684	2N3684 100V 1.0A	0.10
2N3685	2N3685 100V 1.0A	0.10
2N3686	2N3686 100V 1.0A	0.10
2N3687	2N3687 100V 1.0A	0.10
2N3688	2N3688 100V 1.0A	0.10
2N3689	2N3689 100V 1.0A	0.10
2N3690	2N3690 100V 1.0A	0.10
2N3691	2N3691 100V 1.0A	0.10
2N3692	2N3692 100V 1.0A	0.10
2N3693	2N3693 100V 1.0A	0.10
2N3694	2N3694 100V 1.0A	0.10
2N3695	2N3695 100V 1.0A	0.10
2N3696	2N3696 100V 1.0A	0.10
2N3697	2N3697 100V 1.0A	0.10
2N3698	2N3698 100V 1.0A	0.10
2N3699	2N3699 100V 1.0A	0.10
2N3700	2N3700 100V 1.0A	0.10

TERMINATION JUMPERS

SOCKET CONNECTION TERMINATION

P-PCB CONNECTOR TERMINATION

X-CARD EDGE CONNECTOR TERMINATION

Number After Dash is Cable Length in Inches

Part No.	Description	Price
1A	1A 100 Ohm 2.00 1.00 1.00 1.00	0.10
1B	1B 100 Ohm 2.00 1.00 1.00 1.00	0.10
1C	1C 100 Ohm 2.00 1.00 1.00 1.00	0.10
1D	1D 100 Ohm 2.00 1.00 1.00 1.00	0.10
1E	1E 100 Ohm 2.00 1.00 1.00 1.00	0.10
1F	1F 100 Ohm 2.00 1.00 1.00 1.00	0.10
1G	1G 100 Ohm 2.00 1.00 1.00 1.00	0.10
1H	1H 100 Ohm 2.00 1.00 1.00 1.00	0.10
1I	1I 100 Ohm 2.00 1.00 1.00 1.00	0.10
1J	1J 100 Ohm 2.00 1.00 1.00 1.00	0.10
1K	1K 100 Ohm 2.00 1.00 1.00 1.00	0.10
1L	1L 100 Ohm 2.00 1.00 1.00 1.00	0.10
1M	1M 100 Ohm 2.00 1.00 1.00 1.00	0.10
1N	1N 100 Ohm 2.00 1.00 1.00 1.00	0.10
1O	1O 100 Ohm 2.00 1.00 1.00 1.00	0.10
1P	1P 100 Ohm 2.00 1.00 1.00 1.00	0.10
1Q	1Q 100 Ohm 2.00 1.00 1.00 1.00	0.10
1R	1R 100 Ohm 2.00 1.00 1.00 1.00	0.10
1S	1S 100 Ohm 2.00 1.00 1.00 1.00	0.10
1T	1T 100 Ohm 2.00 1.00 1.00 1.00	0.10
1U	1U 100 Ohm 2.00 1.00 1.00 1.00	0.10
1V	1V 100 Ohm 2.00 1.00 1.00 1.00	0.10
1W	1W 100 Ohm 2.00 1.00 1.00 1.00	0.10
1X	1X 100 Ohm 2.00 1.00 1.00 1.00	0.10
1Y	1Y 100 Ohm 2.00 1.00 1.00 1.00	0.10
1Z	1Z 100 Ohm 2.00 1.00 1.00 1.00	0.10

alpha WEG cable tubing

Hookups Wire, Stranded, PVC Insulated

4 Core AWG #18/20 Type B, 500' Roll, 50' to 100'

Part No.	Description	Price
1000	1000 18 AWG 500' Roll	1.00
1001	1001 20 AWG 500' Roll	1.00
1002	1002 18 AWG 100' Roll	0.20
1003	1003 20 AWG 100' Roll	0.20
1004	1004 18 AWG 50' Roll	0.10
1005	1005 20 AWG 50' Roll	0.10
1006	1006 18 AWG 25' Roll	0.05
1007	1007 20 AWG 25' Roll	0.05
1008	1008 18 AWG 10' Roll	0.02
1009	1009 20 AWG 10' Roll	0.02
1010	1010 18 AWG 5' Roll	0.01
1011	1011 20 AWG 5' Roll	0.01

IT SILICON ZENER DIODES

Part No.	Description	Price
1N4733	1N4733 3.3V 500mW	0.10
1N4734	1N4734 3.6V 500mW	0.10
1N4735	1N4735 3.9V 500mW	0.10
1N4736	1N4736 4.3V 500mW	0.10
1N4737	1N4737 4.7V 500mW	0.10
1N4738	1N4738 5.1V 500mW	0.10
1N4739	1N4739 5.6V 500mW	0.10
1N4740	1N4740 6.2V 500mW	0.10
1N4741	1N4741 6.8V 500mW	0.10
1N4742	1N4742 7.5V 500mW	0.10
1N4743	1N4743 8.2V 500mW	0.10
1N4744	1N4744 9.1V 500mW	0.10
1N4745	1N4745 10.0V 500mW	0.10
1N4746	1N4746 11.0V 500mW	0.10
1N4747	1N4747 12.0V 500mW	0.10
1N4748	1N4748 13.0V 500mW	0.10
1N4749	1N4749 15.0V 500mW	0.10
1N4750	1N4750 18.0V 500mW	0.10
1N4751	1N4751 22.0V 500mW	0.10
1N4752	1N4752 27.0V 500mW	0.10
1N4753	1N4753 33.0V 500mW	0.10
1N4754	1N4754 39.0V 500mW	0.10
1N4755	1N4755 47.0V 500mW	0.10
1N4756	1N4756 56.0V 500mW	0.10
1N4757	1N4757 68.0V 500mW	0.10
1N4758	1N4758 82.0V 500mW	0.10
1N4759	1N4759 100.0V 500mW	0.10
1N4760	1N4760 120.0V 500mW	0.10
1N4761	1N4761 150.0V 500mW	0.10
1N4762	1N4762 180.0V 500mW	0.10
1N4763	1N4763 220.0V 500mW	0.10
1N4764	1N4764 270.0V 500mW	0.10
1N4765	1N4765 330.0V 500mW	0.10
1N4766	1N4766 390.0V 500mW	0.10
1N4767	1N4767 470.0V 500mW	0.10
1N4768	1N4768 560.0V 500mW	0.10
1N4769	1N4769 680.0V 500mW	0.10
1N4770	1N4770 820.0V 500mW	0.10
1N4771	1N4771 1000.0V 500mW	0.10
1N4772	1N4772 1200.0V 500mW	0.10
1N4773	1N4773 1500.0V 500mW	0.10
1N4774	1N4774 1800.0V 500mW	0.10
1N4775	1N4775 2200.0V 500mW	0.10
1N4776	1N4776 2700.0V 500mW	0.10
1N4777	1N4777 3300.0V 500mW	0.10
1N4778	1N4778 3900.0V 500mW	0.10
1N4779	1N4779 4700.0V 500mW	0.10
1N4780	1N4780 5600.0V 500mW	0.10
1N4781	1N4781 6800.0V 500mW	0.10
1N4782	1N4782 8200.0V 500mW	0.10
1N4783	1N4783 10000.0V 500mW	0.10
1N4784	1N4784 12000.0V 500mW	0.10
1N4785	1N4785 15000.0V 500mW	0.10
1N4786	1N4786 18000.0V 500mW	0.10
1N4787	1N4787 22000.0V 500mW	0.10
1N4788	1N4788 27000.0V 500mW	0.10
1N4789	1N4789 33000.0V 500mW	0.10
1N4790	1N4790 39000.0V 500mW	0.10
1N4791	1N4791 47000.0V 500mW	0.10
1N4792	1N4792 56000.0V 500mW	0.10
1N4793	1N4793 68000.0V 500mW	0.10
1N4794	1N4794 82000.0V 500mW	0.10
1N4795	1N4795 100000.0V 500mW	0.10
1N4796	1N4796 120000.0V 500mW	0.10
1N4797	1N4797 150000.0V 500mW	0.10
1N4798	1N4798 180000.0V 500mW	0.10
1N4799	1N4799 220000.0V 500mW	0.10
1N4800	1N4800 270000.0V 500mW	0.10

"Programmable" Clock Modules

0.7" or 0.8" Red 4-Digit LED Display

User Programmable Red:
 • One year and up to a 99.99 hours display
 • 60 Hz line frequency
 • 50 Hz and 60 Hz operation
 • 12 or 24 hour display
 • 50 Hz and 60 Hz operation
 • 12 or 24 hour display

Blue:
 • 60 Hz and 50 Hz operation
 • 12 or 24 hour display
 • 50 Hz and 60 Hz operation
 • 12 or 24 hour display

Typical Applications include:
 Clock • Time • Alarm Clock • Desk Clock • TV and Stereo • Timer • Industrial Panel Clock • Digital Transmitter and much more...

Part No.	Description	Price
MA1026	MA1026 clock module only	62.79
MA1027	Digi-Key switch panel for P.C.	11.99
MA1028	Time-Temp. Clock Module	74.78
MA1029	Time-Temp. Clock Module	74.78
MA1030	Time-Temp. Clock Module	74.78
MA1031	Time-Temp. Clock Module	74.78
MA1032	Time-Temp. Clock Module	74.78
MA1033	Time-Temp. Clock Module	74.78
MA1034	Time-Temp. Clock Module	74.78
MA1035	Time-Temp. Clock Module	74.78
MA1036	Time-Temp. Clock Module	74.78
MA1037	Time-Temp. Clock Module	74.78
MA1038	Time-Temp. Clock Module	74.78
MA1039	Time-Temp. Clock Module	74.78
MA1040	Time-Temp. Clock Module	74.78
MA1041	Time-Temp. Clock Module	74.78
MA1042	Time-Temp. Clock Module	74.78
MA1043	Time-Temp. Clock Module	74.78
MA1044	Time-Temp. Clock Module	74.78
MA1045	Time-Temp. Clock Module	74.78
MA1046	Time-Temp. Clock Module	74.78
MA1047	Time-Temp. Clock Module	74.78
MA1048	Time-Temp. Clock Module	74.78
MA1049	Time-Temp. Clock Module	74.78
MA1050	Time-Temp. Clock Module	74.78

1% Metal Film Resistors

Wattage Temperature Coefficient - 500 ppm/°C
Classified Withstanding Voltage 500V

Standard Resistor Values from 10 to 1,000,000 Ohms

Part No.	Description	Price
100	100 10 Ohm 1/4W	0.10
101	101 11 Ohm 1/4W	0.10
102	102 12 Ohm 1/4W	0.10
103	103 13 Ohm 1/4W	0.10
104	104 15 Ohm 1/4W	0.10
105	105 16 Ohm 1/4W	0.10
106	106 18 Ohm 1/4W	0.10
107	107 20 Ohm 1/4W	0.10
108	108 22 Ohm 1/4W	0.10
109	109 24 Ohm 1/4W	0.10
110	110 27 Ohm 1/4W	0.10
111	111 30 Ohm 1/4W	0.10

SKYFOX

State-of-the-Art Excellence

SKYFOX DESIGN PERFORMANCE FEATURES:

- Gain 55 db • Frequency 1.9-2.5 GHz
- Range 55 miles maximum
- Tuning channels 2-6
- 20 inch Parabolic dish antenna
- 60 ft. cable • Cable adapters, mounting brackets and hardware included • Illustrated instructions

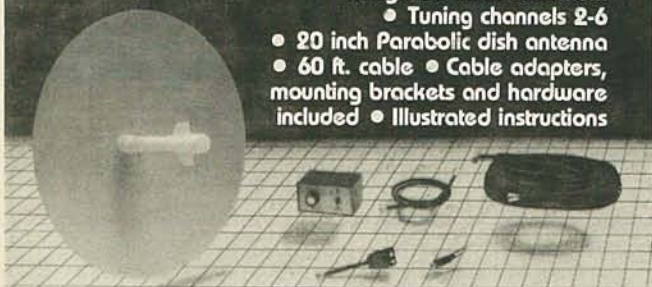

Receive movies, special presentations and educational broadcasts — ALL FREE — with the SKYFOX deep fringe microwave receiver for homeowners outside the service area of microwave TV stations. SKYFOX receives up to a distance of 55 miles. From microwave transmitters located on buildings or towers in almost all medium and large size cities. SKYFOX does not receive Cable TV or satellite transmissions.

SKYFOX I \$ 79.95 (not pictured, 25 mile line of site)

SKYFOX II \$109.95 (as shown, 55 mile line of site)

ORDERS ONLY: Toll Free 1-800-323/1327

For Information Call: 1-312/564-0104

Visa, Mastercharge accepted. COD, cash or Money Order only. When ordering by mail, Money Orders or Cashiers Checks only. Personal checks, wait 4 weeks for check clearance.

90 day warranty • Conditional money back guarantee

S.E.I. Inc.

657 Academy Drive
Northbrook, Illinois 60062

CIRCLE 55 ON FREE INFORMATION CARD

Available by Mail Order Only



"THE NEW DELUXE II"

The new leader in sinewave technology is now available at industry shattering prices. We also have the new and improved plusewave kit.

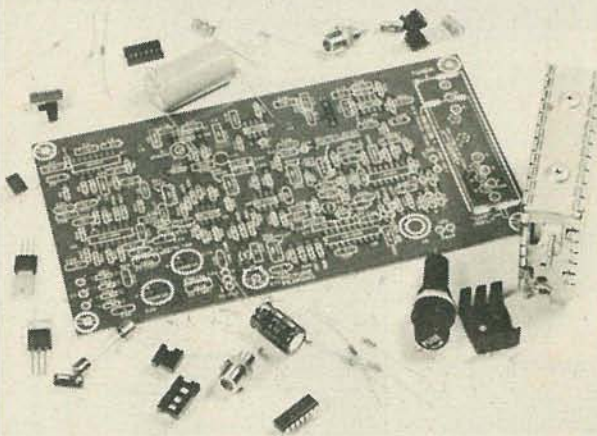

New Deluxe II Board with free-complete assembly plans 20.00

New Deluxe II complete kit and enclosure 119.95

Pulse Wave AD-1 board with free complete assembly plans 20.00

Pulse Wave AD-1 complete kit and enclosure 119.95

Add 5% shipping and handling for Continental U.S. Add 10% shipping and handling for outside Continental U.S.

GAMMA ELECTRONICS

455 Massachusetts Avenue
Arlington, Mass. 02174

To Order Call:

1-617-641-0778



DEALERS WANTED

CIRCLE 21 ON FREE INFORMATION CARD

Components is Our First Name Call Us with Your Requirements



NEW 12" Green Monitor

Easy on the Eyes. Connects to most popular computers w/o interface or modifications

\$89⁰⁰

APPLE IIe 64K RAM CARD

80 x 24, 64K RAM

Compatible with Apple IIe Software **\$149⁰⁰**

for APPLE

16K RAM CARD

Language Transparent
COEX FACTORY WARRANTY **\$69⁹⁵**

5 1/4" Floppy DISKETTES

All Certified-100% Guaranteed

BOX of 100 ... **\$149⁰⁰**

Above with Hub Rings **\$169.00**

FLOPPY DISK DRIVE

Apple IIe Compatible

with • Track Zero Micro Switch
• DOS 3.2.1 & DOS 3.3
• CP/M and PASCAL

DESIGNED FOR YOUR APPLE™ **\$235⁰⁰**

Controller Card for above **\$75.00**

COEX 80-FT DOT MATRIX PRINTER

- 9x7 Dot Matrix, 80 CPS, Bi-Directional Printing
- 2K Buffered Memory
- 80, 96, 132 Columns, Graphics and Block Printing
- Selectable Char Pitch, Line Spacing and Feed



PARALLEL
COEX Interface Card to Apple .. **\$49.95**
Commodore Interface Card to VIC, 64, PET **\$79.95**

\$275⁰⁰

VISION-80® \$229⁰⁰

80x24 Video Display Card
Vista Computer Company's new Vision-80 board is a sophisticated yet easy to use video display card for the Apple™ computer.

EXTENDER CARDS

for APPLE... **\$16.95**
for I.B.M.... **\$19.95**

DO YOU HAVE A COMMODORE?

NEW ROM for COEX 80 & DP8480

Allows Full Graphics Compatibility with All Commodore Computers **\$29⁹⁵**

PARALLEL INTERFACE EPSON TO APPLE

New From COEX **\$49⁹⁵** CABLE INCLUDED

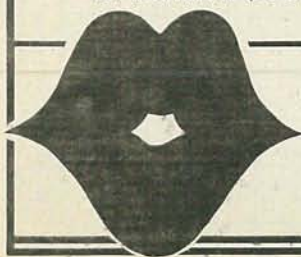

"Have You Kissed Your Computer Lately?"

Components Express, Inc.

1380 E. Edinger • Santa Ana, Calif. 92705 • 714/558-3972

TWX 910-595-1565 • ADVACON SNA • International Orders Welcome

Terms of Sale: Cash, Checks, Credit Cards, M.O., C.O.D. FOB Santa Ana. Calif. residents add 6% sales tax.



CIRCLE 88 ON FREE INFORMATION CARD

ADVANCED COMPUTER PRODUCTS

SEND \$2.00 for 1983 CATALOG

16K Apple™ Ramcard

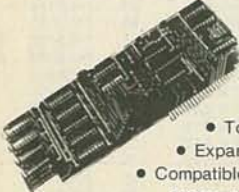

LIST 195
ACP
\$59.95

- Full 1 year warranty
- Top quality — gold fingers
- Expand Apple II 48K to 64K
- Compatible with Z-80 Softcard™

NOW AVAILABLE

Apple IIe 64K Add-in Memory with 80 Columns \$149.95

32K STATIC RAM



2 or 4 MHz Expandable Uses 2114L's
16K 4 MHz Kit \$159.95
16K 4 MHz A&T 217.95
32K 4 MHz Kit \$129.95
32K 4 MHz A&T 339.00
BARE BOARD 39.95
Bare Bd w/all parts less mem. 99.95

REPEAT OF SELL-OUT 58 Key Unencoded Keyboard



\$19.95 ea.
This is a new 58 key terminal Keyboard manufactured by a major manufacturer. It is unencoded with SPST keys, unattached to any PC board. Solid molded plastic 11" x 4" base

Unencoded Key Pad

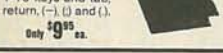

15 key Keypad with 1-10 keys and tab, return, (-), () and (). Only \$9.95 ea.

UV "EPROM" ERASER

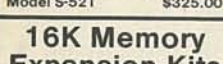

Model DE-4 \$89.95
Holds 4 EPROM's at a time \$325.00
Model S-52T

16K Memory Expansion Kits for Apple/TRS-80

8 pcs 4116 16K 200/250ns Specify computer \$12.95
CALL FOR VOLUME PRICING

CORCOM FILTER



Popular CORCOM Filter 6 amps \$4.95
Compatible Line Cord Add \$3.50

9 pcs 4164 D-RAM \$50.00

AMD MODEM IC P/N AM7910 1200Baud 5 Volts Special ACP Price \$99.00

PARALLEL ALPHA NUMERIC PRINTER

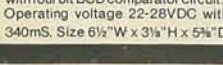

19 Column Printer prints 16 numerical columns plus 3 columns which have math, alpha and other notations. Each wheel has 12 positions with position 12 blank. Using 4-bit BCD comparator circuit. Print rate, 3 lines per second. Operating voltage 22-28VDC with typical cycle time of 340ms. Size 6 1/2" W x 3 1/2" H x 5 1/2" Dp. New. \$8.95 ea. \$32.5

64K CMOS RAMCARD



IEEE Compatible Uses 6116 IC's Low Power Single Supply Asm and Tested \$269.00

INTEL 4K STATIC RAMS

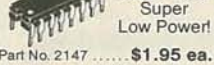

Super Fast! Super Low Power! Part No. 2147 \$1.95 ea.

STEPPER MOTOR

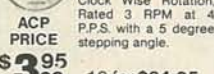

Operates by applying 12VDC in one direction and then reversing polarity (or square wave). Uses 12VDC, Clock Wise Rotation, Rated 3 RPM at 4 P.P.S. with a 5 degree stepping angle. ACP PRICE \$3.95 ea. 10 for \$34.95

RS232 SIGNAL TESTER



COEX RS232 Line Tester (7) LED Indicators only \$24.95
Other Styles Also Available

INTEL CODEC IC

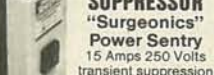

P/N 2910A For Digital Voice For Filter P/N 2912A \$4.95 ea. \$9.95 ea.

SURGE SUPPRESSOR



"Surgeonics" Power Sentry 15 Amps 250 Volts transient suppression ACP Low Price \$39.95

CONNECTORS

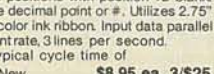

DB25P (RS232) \$3.25
DB25S Female 3.75
Hood 1.25
Set with Hood, Sale 7.50
22/44 S/T, KIM 2.95
43/86 S/T, MOT 6.50
50/100 S-100 Connector W/W 4.95
50/100 S-100 Connector S/T 3.95

MICROPROCESSORS

Z8001	\$99.00	8008-1	\$14.95	6802P	14.95
Z8002	89.00	2901	9.90	8035	14.95
Z8003	9.95	2901A	14.95	8039	12.95
Z8004	11.95	9202A	49.95	8073H	34.95
F-8 (3050)	16.95	6502	9.95	8755	49.95
2650	16.95	6502A	16.95	8748	49.95
1602	9.75	860100	29.95	6800	29.95
8280A	4.75	6800	11.75	8096	49.95
8095	14.95	6800B	19.95	6800	129.95

RAMS

6116/2016	\$7.95	2147	\$5.99	5250	\$1.99
8254-64K	5.95	411	5.99	5298	1.49
4116-2	1.99	414	4.69	5508	4.50
4116-2	8/12.95	1101	.99	8518	8.79
2101	3.99	1103	.99	8561	3.79
2102	.79	4027	4.69	8604	3.99
21L02-2	1.49	4044	3.99	6005	7.99
21L02-4	1.29	4050	4.69	9130	8.99
2111	3.49	4060	6.99	9140	8.99
2112	3.49	4096	3.99	9345	6.99
2114	1.99	4115	1.49	9345	6.99
2114L-2	3.25	4122	7.95		
2114L-4	2.29	4402	1.99		
2125	6.99	5280	4.60		

SUPPORT

8155	\$9.95	8259	\$5.95	68047	\$22.95
8156	9.95	8275	19.95	68400	19.95
8202	29.95	8279	9.50	45505	22.95
8205	2.69	6810	4.75	6520	6.95
8212	2.75	6820	8.50	6522	9.95
8214	4.95	6821	8.50	6530-X	24.95
8216	2.75	6828	10.50	6532	17.95
8224	2.95	6834	16.95	6551	19.95
8226	2.95	6845	22.95	Z80-PIO	6.50
8228	3.95	6847	27.95	Z80A-PIO	9.50
8243	9.50	6850	5.25	Z80-CTC	6.50
8250	14.95	6852	5.25	Z80A-CTC	9.50
8251	6.50	6850	10.95	Z80-DMA	19.95
8253	11.95	6852	10.95	Z80A-DMA	27.95
8255	4.50	6875	5.95	Z80-SIO	24.95
8257	9.50	6880	2.49	Z80-SIO	29.95

MOS PROMS

2764 (8Kx8) TS	\$98.95	2708 (40x8)S	\$5.75
2732 (4Kx8) TS	12.95	2708 (60x8)S	5.25
2716/2516: 5V (2Kx8) TS	7.95	1702A	5.75
2716/2516: 5V (2Kx8) TS	7.95	MMS203AQ	14.50
TMS2716: 5V, 12V	17.95	MMS204Q	9.95
2758: 5V, (40x8)S	3.50		

HI-TECH

2513-001 (5V) Upper	\$9.50	DAC08	\$9.95
2513-005 (5V) Lower	10.95	DAC100	89.95
2513-ADM3 (5V) Lower	14.95	8038 Funct.-1 Generator	4.00
MCM6670 ASG1 Shift Register	3.95	MS404 VCO	2.95
MCM66740 Math Symbol 13.95		LM566 VCO	1.95
MCM66750 Alpha Control 13.45		SR206 Function Generator	5.25
1771-01 (8" & Mini) 24.95		TR10202 (5V, 12V)	3.95
1781 Dual Floppy	29.95	AY51013 (5V, 12V)	4.95
1791-01 Dual Floppy	39.95	AY51014A/1612 (5-14V)	6.95
1791-02 Dual Floppy	44.95	AY51015A/1603 (5V)	6.95
1793 DD, DS Floppy	44.95	IM6402	7.95
1797 DD, DS Floppy	54.95	MM403	8.95
1881 Data Separator	18.95	2350 USTR	34.95
2143 Clock Generator	18.95	18718 Astr	34.95
8708 8 bit Binary	13.50	MC14411	11.95
8701 16 bit Binary	22.00	4703	14.95
8703 8 bit TS	13.50	U01941	9.95
9450 Volt to Pres Comp	7.25	COM5016	16.95
8750 3 1/2 Digit BCD	13.95	IN82520	15.95
1408L 8 bit	3.95	AY5-2376	13.75
1408L 8 bit	5.95	AY5-3069	13.75
DAC01 D to A	5.95	MMS740AAC	8.95

SOCKETS

8 pin LP	16	15	14
14 pin LP	20	19	18
16 pin LP	22	21	20
18 pin LP	29	28	27
20 pin LP	34	33	30
22 pin LP	29	27	24
24 pin LP	38	37	36
28 pin LP	45	44	43
40 pin LP	60	59	58

LOW PROFILE SOCKETS (TIN)

8 pin WW	55	54	49
10 pin WW (Tin)	65	63	58
14 pin WW	75	73	67
16 pin WW	80	77	70
18 pin WW	95	94	81
20 pin WW	115	108	99
22 pin WW	145	135	123
24 pin WW	135	126	114
28 pin WW	180	153	138
40 pin WW	220	209	189

3L WIREWRAP SOCKETS (GOLD)

8 pin WW	55	54	49
10 pin WW (Tin)	65	63	58
14 pin WW	75	73	67
16 pin WW	80	77	70
18 pin WW	95	94	81
20 pin WW	115	108	99
22 pin WW	145	135	123
24 pin WW	135	126	114
28 pin WW	180	153	138
40 pin WW	220	209	189

CONNECTORS

DB25P (RS232)	\$3.25
DB25S Female	3.75
Hood	1.25
Set with Hood, Sale	7.50
22/44 S/T, KIM	2.95
43/86 S/T, MOT	6.50
50/100 S-100 Connector W/W	4.95
50/100 S-100 Connector S/T	3.95

SUPER IC CLOSEOUT SPECIALS

14411	\$7.95	6571A	\$6.95	8080A CPU	\$2.95	5027 CRT	\$9.95
74LS668	3/1.99	593 2652	3.95	2102 RAM	1.50		
74LS377	2/1.99	8253	6.95	4060 RAM	1.40	8039	3.95
74LS241	2/1.99	2758 EPROM	2.95	2732	6.95	MMS320	5.99
8259	6.95	1802	8.95	UPD410	2.98	9131 RAM	1.99
8261 RAM	2.95	Z80A CPU	4.95	UPD411	2.98	EMM4402	1.99
LM733CN	3/1.99	6522	6.95	2708 EPROM	8/29.95	10415	4.95
LM323K	3.95	6502 CPU	5.95	2114	8/14.50	8700 A/D	2/16.95

TOLL FREE 800-854-8230 TWX 910-595-1565

LINEAR

78H05K	\$5.95	LM1414N	\$1.90
78M06	1.49	LM1458CN	.49
78M.G.	1.49	MC1488N	.99
LM108AH	2.95	MC1499N	.99
LM3001	.99	LM1498N	.89
LM301CN	.95	LM1559N	1.50
LM304H	1.08	LM1820N	.95
LM305H	1.89	LM1850N	.95
LM306H	3.25	LM1889N	1.10
LM307CN	.29	LM2111N	3.75
LM308CN	.98	LM2900N	.99
LM309K	1.49	LM2901N	2.50
LM310CN	1.25	LM2917N	2.95
LM311D/CN	.89	CA3013T	2.19
LM312H	1.75	CA3018T	1.99
LM317T	1.70	CA3021T	3.49
LM318CN	1.49	CA3022T	2.99
LM319H/N	1.25	CA3035T	2.75
LM320K-XX*	1.35	CA3039T	1.29
LM320T-XX*	1.39	CA3048N	1.29
LM324N	.95	CA3062N	4.95
LM324N	.95	CA3069N	1.49
LM337K	6.95	CA3080T	1.29
LM338K	6.95	CA3081N	1.69
LM339N	.95	CA3082N	1.29
LM340T-XX*	1.25	CA3083N	1.55
LM340H-XX*	1.25	CA3086N	.80
LM344H	1.95	CA3089N	2.99
LM348N	1.20	CA3098N	3.49
LM350K	.98	CA3097N	1.99
LM358CN	1.49	CA3130T	1.30
LM372N	1.95	CA3140T	1.19
LM376N	3.75	CA3160T	1.19
LM377N	2.75	CA3190N	1.95
LM380CN/N	1.25	CA1120N	.59
LM381N	1.79	MC3423N	1.49
LM383T	1.95	MC3460N	3.95
LM386N	1.25	SG3524N	3.95
LM387N	1.40	CA3000N	3.99
LM390N	1.95	CA3007N	5.99
LM395CN	3.75	LM3905N	1.19
NE555V	.98	LM3909N	.98
NE556N	.98	LM3914N	3.75
NE561T	19.95	LM3915N	3.75
NE655N/H	1.25	RC4131N	2.95
NE656N/H	1.75	RC4136N	1.10
NE657V/H	1.50	RC4151N	3.70
NE929N	2.75	RC4194TK	4.95
LM702H	1.99	CA1195TK	5.40
LM709N/H	.29	CA1200	1.25
LM710N/H	.75	LN2003	1.50
LM711N/H	1.95	SN75450N	.85
LM715N	1.95	SN75451N	.35
LM723N/H	.85	SN75452N	.89
LM733N/H	.98	SN75453N	.49
LM739N	1.15	SN75454N	.89
LM741CN/H	.33	SN75491N	.89
LM741CN-14	.19	SN75492N	.89
LM747N/H	.75	SN75493N	.89
LM748N/H	.39	TL494CN	4.20
LM760CN	2.95	TL496CP	1.65

4164

64K DYNAMIC 200 NS

\$595

TMM2016

2KX8 STATIC 200 NS

\$415

STATIC RAMS

2101	256 x 4 (450ns)	1.95
5101	256 x 4 (450ns) (cmos)	3.95
2102-1	1024 x 1 (450ns)	.89
2102L-4	1024 x 1 (450ns) (LP)	.99
2102L-2	1024 x 1 (250ns) (LP)	1.49
2111	256 x 4 (450ns)	2.49
2112	256 x 4 (450ns)	2.99
2114	1024 x 4 (450ns)	8/9.95
2114-25	1024 x 4 (250ns)	8/10.95
2114L-4	1024 x 4 (450ns) (LP)	8/12.95
2114L-3	1024 x 4 (300ns) (LP)	8/13.45
2114L-2	1024 x 4 (200ns) (LP)	8/13.95
2147	4096 x 1 (55ns)	4.95
TMS4044-4	4096 x 1 (450ns)	3.49
TMS4044-3	4096 x 1 (300ns)	3.99
TMS4044-2	4096 x 1 (200ns)	4.49
MK4118	1024 x 8 (250ns)	9.95
TMM2016-200	2048 x 8 (200ns)	4.15
TMM2016-150	2048 x 8 (150ns)	4.95
TMM2016-100	2048 x 8 (100ns)	6.15
HM6116-4	2048 x 8 (200ns) (cmos)	4.75
HM6116-3	2048 x 8 (150ns) (cmos)	4.95
HM6116-2	2048 x 8 (120ns) (cmos)	8.95
HM6116LP-4	2048 x 8 (200ns) (cmos)(LP)	5.95
HM6116LP-3	2048 x 8 (150ns) (cmos)(LP)	6.95
HM6116LP-2	2048 x 8 (120ns) (cmos)(LP)	10.95
Z-6132	4096 x 8 (300ns) (Qstat)	34.95

LP = Low Power Qstat = Quasi-Static

Z-80

2.5 Mhz	
Z80-CPU	3.95
Z80-CTC	4.49
Z80-DART	10.95
Z80-DMA	14.95
Z80-PIO	4.49
Z80-SIO/0	16.95
Z80-SIO/1	16.95
Z80-SIO/2	16.95
Z80-SIO/9	16.95

4.0 Mhz

Z80A-CPU	4.95
Z80A-CTC	4.95
Z80A-DART	11.95
Z80A-DMA	16.95
Z80A-PIO	4.95
Z80A-SIO/0	16.95
Z80A-SIO/1	16.95
Z80A-SIO/2	16.95
Z80A-SIO/9	16.95

6.0 Mhz

Z80B-CPU	11.95
Z80B-CTC	13.95
Z80B-PIO	13.95
Z80B-DART	19.95

ZILOG

Z6132	34.95
Z8671	39.95

8000

8035	5.95
8039	6.95
INS-8060	17.95
INS-8073	24.95
8080	3.95
8085	5.95
8085A-2	11.95
8086	29.95
8087	CALL
8088	39.95
8089	89.95
8155	6.95
8155-2	7.95
8156	6.95
8156-2	29.95
8185-2	39.95
8741	39.95
8748	24.95
8755	24.95

8200

8202	24.95
8203	39.95
8205	3.50
8212	1.80
8214	3.85
8216	1.75
8224	2.25
8226	1.80
8228	3.49
8237	19.95
8237-5	21.95
8238	4.49
8243	4.45
8250	10.95
8251	4.49
8253	6.95
8253-5	7.95
8255	4.49
8255-5	5.25
8257	7.95
8257-5	8.95
8259	6.90
8259-5	7.50
8271	39.95
8272	39.95
8275	29.95
8279	8.95
8279-5	10.00
8282	6.50
8283	6.50
8284	5.50
8286	6.50
8287	6.50
8288	25.00
8289	49.95

6800

68000	59.95
6800	3.95
6802	7.95
6808	13.90
6809E	19.95
6809	11.95
6810	2.95
6820	4.35
6821	3.25
6828	14.95
6840	12.95
6843	34.95
6844	25.95
6845	14.95
6847	11.95
6850	3.25
6852	5.75
6860	9.95
6862	11.95
6875	6.95
6880	2.25
6883	22.95
68047	24.95
68488	19.95

6500

6800 = 1MHZ	
68B00	10.95
68B02	22.25
68B09E	29.95
68B09	29.95
68B10	6.95
68B21	6.95
68B45	19.95
68B50	5.95
68B00 = 2 MHZ	
6502	4.95
6504	6.95
6505	8.95
6507	9.95
6520	4.35
6522	7.95
6532	9.95
6545	22.50
6551	11.85

2 MHZ

6502A	6.95
6522A	9.95
6532A	11.95
6545A	27.95
6551A	11.95
6502B	14.95

3 MHZ

6502B	14.95
-------	-------

UARTS

AY3-1014	6.95
AY5-1013	3.95
AY3-1015	6.95
PT1472	9.95
TR1602	3.95
2350	9.95
2651	8.95
TMS6011	5.95
IM6402	7.95
IM6403	8.95
INS8250	10.95

GENERATORS

BIT-RATE	
MC14411	11.95
BR1941	11.95
4702	12.95
COM5016	16.95
COM8116	10.95
MMS307	10.95

FUNCTION

MC4024	3.95
LM566	1.49
XR2206	3.75
8038	3.95

DYNAMIC RAMS

TMS4027	4096 x 1 (250ns)	1.99
UPD411	4096 x 1 (300ns)	3.00
MMS280	4096 x 1 (300ns)	3.00
MK4108	8192 x 1 (200ns)	1.95
MMS298	8192 x 1 (250ns)	1.85
4116-300	16384 x 1 (300ns)	8/11.75
4116-250	16384 x 1 (250ns)	8/11.95
4116-200	16384 x 1 (200ns)	8/12.95
4116-150	16384 x 1 (150ns)	8/14.95
4116-120	16384 x 1 (120ns)	8/29.95
2118	16384 x 1 (150ns) (5v)	4.95
4164-200	65536 x 1 (200ns) (5v)	5.95
4164-150	65536 x 1 (150ns) (5v)	6.95

5V = single 5 volt supply

EPROMS

1702	256 x 8 (1us)	4.50
2708	1024 x 8 (450ns)	3.95
2758	1024 x 8 (450ns) (5v)	5.95
2716	2048 x 8 (450ns) (5v)	3.95
2716-1	2048 x 8 (350ns) (5v)	5.95
TMS2516	2048 x 8 (450ns) (5v)	5.50
TMS2716	2048 x 8 (450ns)	7.95
TMS2532	4096 x 8 (450ns) (5v)	5.95
2732	4096 x 8 (450ns) (5v)	4.95
2732-250	4096 x 8 (250ns) (5v)	8.95
2732-200	4096 x 8 (200ns) (5v)	11.95
2764	8192 x 8 (450ns) (5v)	9.95
2764-250	8192 x 8 (250ns) (5v)	14.95
2764-200	8192 x 8 (200ns) (5v)	24.95
TMS2564	8192 x 8 (450ns) (5v)	17.95
MC68764	8192 x 8 (450ns) (5v) (24 pin)	39.95
27128	16384x8 Call	Call

5v = Single 5 Volt Supply

EPROM ERASERS

	Timer	Capacity Chip	Intensity (uW/Cm ²)	
PE-14		6	5,200	83.00
PE-14T	X	6	5,200	119.00
PE-24T	X	9	6,700	175.00
PL-265T	X	20	6,700	255.00
PR-125T	X	16	15,000	349.00
PR-320	X	32	15,000	595.00

CRYSTALS

32.768 khz	1.95
1.0 mhz	4.95
1.8432	4.95
2.0	3.95
2.097152	3.95
2.4576	3.95
3.2768	3.95
3.579535	3.95
4.0	3.95
5.0	3.95
5.0688	3.95
5.185	3.95
5.7143	3.95
6.0	3.95
6.144	3.95
6.5536	3.95
8.0	3.95
10.0	3.95
10.738635	3.95
14.31818	3.95
15.0	3.95
16.0	3.95
17.430	3.95
18.0	3.95
18.432	3.95
20.0	3.95
22.1184	3.95
32.0	3.95

CRT CONTROLLERS

6845	14.95
68B45	19.95
HD46505SP	15.95
6847	11.95
MC1372	6.95
68047	24.95
8275	29.95
7220	99.95
CRT5027	39.95
CRT5037	49.95
TMS9918A	39.95
DP8350	49.95

KEYBOARD CHIPS

AY5-2376	11.95
AY5-3600	11.95
AY5-3600 PRO	11.95

DISC CONTROLLERS

1771	16.95
1791	24.95
1793	26.95
1795	49.95
1797	49.95
2791	54.95
2793	54.95
2795	59.95
2797	59.95
6843	34.95
8272	39.95
UPD765	39.95
MB8876	29.95
MB8877	34.95
1691	17.95
2143	18.95

CONNECTORS

RS232 MALE	2.50
RS232 FEMALE	3.25
RS232 HOOD	1.25
S-100 ST	3.95

VISIT OUR RETAIL STORE

HOURS: M-W-F, 9-5 T-Th., 9-9 Sat. 11-3

PLEASE USE YOUR CUSTOMER NUMBER WHEN ORDERING
TERMS: For shipping include \$2 for UPS Ground or \$3 for UPS Blue Label Air. Items over 5 pounds require additional shipping charges. Foreign orders, include sufficient amount for shipping. There is a \$10 minimum order. Bay Area and Los Angeles Counties add 6 1/2% Sales Tax. Other California residents add 6% Sales Tax. We reserve the right to substitute manufacturer. Not responsible for typographical errors. Prices are subject to change without notice. We will match or beat any competitor's price provided it is not below our cost.

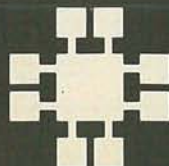

JDR Microdevices

1224 S. Bascom Ave. • San Jose, CA 95128

(408) 995-5430 • Telex 171-110

© 1983 JDR MICRODEVICES, INC.

CIRCLE 49 ON FREE INFORMATION CARD

2114 450 NS 8/\$995

2114 250 NS 8/\$1095

7400

Table of 7400 series components with prices. Includes parts like 7400, 7401, 7402, etc., up to 74128.

LINEAR

Table of Linear components with prices. Includes parts like LM301, LM301H, LM307, etc., up to LM339.

Table of Linear components with prices. Includes parts like LM566, LM567, LM570, etc., up to LM13700.

RCA

Table of RCA components with prices. Includes parts like CA 3023, CA 3039, CA 3046, etc., up to CA 3160.

TI

Table of TI components with prices. Includes parts like TL494, TL496, TL497, etc., up to TL083.

BI FET

Table of BI FET components with prices. Includes parts like TL071, TL072, TL074, etc., up to TL083.

CMOS

Table of CMOS components with prices. Includes parts like 4000, 4001, 4002, etc., up to 74C929.

H = TO-5 CAN T = TO-220 K = TO-3

74S00

Table of 74S00 series components with prices. Includes parts like 74S00, 74S02, 74S03, etc., up to 74S162.

INTERFACE

Table of Interface components with prices. Includes parts like 8T26, 8T28, 8T95, etc., up to DS8836.

MISC.

Table of Miscellaneous components with prices. Includes parts like TMS99532, ULN2003, 3242, etc., up to 2513-002 LOW.

VOLTAGE REGULATORS

Table of Voltage Regulators with prices. Includes parts like 7805T, 78M05C, 7808T, etc., up to UA78S40.

C, T = TO-220 K = TO-3 L = TO-92

IF YOU CAN FIND A PRICE LOWER ELSEWHERE, LET US KNOW AND WE WILL MEET OR BEAT THEIR PRICE! (SEE TERMS BELOW)

- * Computer managed inventory - virtually no back orders!
* Very competitive prices!
* Friendly staff!
* Fast service - most orders shipped within 24 hours!

CLOCK CIRCUITS

Table of Clock Circuits with prices. Includes parts like MM5314, MM5369, MM5375, etc., up to MSM5632.

INTERSIL

Table of Intersil components with prices. Includes parts like ICL7106, ICL7107, ICL7660, etc., up to ICM7208.

9000

Table of 9000 series components with prices. Includes parts like 9316, 9334, 9368, etc., up to 96S02.

EXAR

Table of EXAR components with prices. Includes parts like XR 2206, XR 2207, XR 2208, etc., up to XR 2240.

DATA ACQUISITION

Table of Data Acquisition components with prices. Includes parts like ADC0800, ADC0804, ADC0809, etc., up to MC1408L8.

SOUND CHIPS

Table of Sound Chips with prices. Includes parts like 76477, 76489, AY3-8910, etc., up to MC3340.

ORDER TOLL FREE ALL MERCHANDISE 100% GUARANTEED

800-538-5000

800-662-6279 (CALIFORNIA RESIDENTS)

CALL US FOR VOLUME QUOTES



1983 JDR MICRODEVICES, INC.

CIRCLE 49 ON FREE INFORMATION CARD

CABINETS FOR 5 1/4" DISK DRIVES

CABINET #1 \$29.95

- * DIMENSIONS 8 3/4" x 5 1/2" x 3 1/2"
- * COLOR MATCHES APPLE
- * FITS STANDARD 5 1/4" DRIVES, INCL. SHUGART
- * INCLUDES MOUNTING HARDWARE AND FEET

CABINET #2 \$79.00

- * COMPLETE WITH POWER SUPPLY, SWITCH, LINE CORD, FUSE & STANDARD POWER CONNECTOR
 - * DIMENSIONS: 11 1/2" x 5 3/4" x 3 1/2"
 - * +5V @ 1 AMP, +12V @ 1.5 AMP
 - * FITS STANDARD 5 1/4" DRIVES
 - * PLEASE SPECIFY GRAY OR TAN
- NOTE: Please include sufficient amount for shipping on above items.

CONNECTORS

RS232 MALE	2.50
RS232 FEMALE	3.25
RS232 FEMALE RIGHT ANGLE	5.25
RS232 HOOD	1.25
S-100 ST	3.95
S-100 WW	4.95
44 pin ST	2.95
44 pin WW	4.95
72 pin ST	6.95
72 pin WW	7.95

SWITCHES

SPDT mini-toggle	1.25
DPDT mini-toggle	1.50
SPDT push-button	1.49

OPTO-ISOLATORS

MCA-7	1.50
MCA-255	1.75
IL-1	1.25
ILA-30	1.25
ILQ-74	2.75
H11C5	1.25
TIL-111	1.00
TIL-113	1.75
4N26	1.00
4N27	1.10
4N28	.69
4N33	1.75
4N35	1.25
4N37	1.25
MCT-2	1.00
MCT-6	1.50

TRANSISTORS

2N918	.50	2N3772	1.85
MPS918	.25	2N3903	.25
2N2102	.50	2N3904	.10
2N2218	.50	2N3906	.10
2N2218A	.50	2N4122	.25
2N2219	.50	2N4123	.25
2N2219A	.50	2N4249	.25
2N2222	.25	2N4304	.75
PN2222	.10	2N4401	.25
MPS2369	.25	2N4402	.25
2N2484	.25	2N4403	.25
2N2905	.50	2N4857	1.00
2N2907	.25	PN4916	.25
PN2907	.125	2N5086	.25
2N3055	.79	PN5129	.25
3055T	.69	PN5139	.25
2N3393	.30	2N5209	.25
2N3414	.25	2N6028	.35
2N3563	.40	2N6043	1.75
2N3565	.40	2N6045	1.75
PN3565	.25	MPS-A05	.25
MPS3638	.25	MPS-A06	.25
MPS3640	.25	MPS-A55	.25
PN3643	.25	TIP29	.65
PN3644	.25	TIP31	.75
MPS3704	.15	TIP32	.79
MPS3706	.15		

MICROCOMPUTER HARDWARE HANDBOOK FROM ELCOMP — \$14.95

Over 800 pages of manufacturers data sheets on most commonly used IC's.

- Includes:
- * TTL — 74/74LS and 74F
 - * CMOS
 - * Voltage Regulators
 - * Memory — RAM, ROM, EPROM
 - * CPU's — 6800, 6500, Z80, 8080, 8085, 8086/8
 - * MPU support & interface — 6800, 6500, Z80, 8200, etc.

HEAT SINKS

TO-3 style	.95
TO-220 style	.35

DISK DRIVES

TANDON

TM100-1	5 1/4" (FOR IBM) SS/DD	229.00
TM100-2	5 1/4" (FOR IBM) DS/DD	295.00

SHUGART

SA 400L	5 1/4" (40 TRACK) SS/DD	199.95
SA 400	5 1/4" (35 TRACK) SS/DD	189.95

SIEMENS

FD100-8	8" SS/DD (801 REPLACEMENT)	259.00
---------	----------------------------	--------

PERTEC

FD-200	5 1/4" SS/DD	179.95
FD-250	5 1/4" DS/DD	199.95

MPI

MP-52	5 1/4" (FOR IBM) DS/DD	295.00
-------	------------------------	--------

POWER SUPPLY MODEL 2 \$39.95

MOUNTED ON PC BOARD
MANUFACTURED BY CONVER

- +5 VOLT 4 AMP
- ±12 VOLT 1 AMP

NOTE: Please include sufficient amount for shipping on above items.

DIODES

1N751	5.1 volt zener	.25
1N759	12.0 volt zener	.25
1N4148	(1N914) switching	25/1.00
1N4004	400PIV rectifier	10/1.00
KBP02	200PIV 1.5amp bridge	.45
KBP04	400PIV 1.5amp bridge	.55

WE HAVE THE COMPLETE LINE OF DISC, TANTALUM AND ELECTROLYTIC CAPACITORS IN STOCK!

D-SUBMINIATURE

DESCRIPTION	SOLDER		RIGHT ANGLE SOLDER		RIBBON CABLE		HOODS	
	MALE	FEMALE	MALE	FEMALE	MALE	FEMALE	BLACK	GREY
ORDER BY	DBxxP	DBxxS	DBxxPR	DBxxSR	IDBxxP	IDBxxS	HOOD-B	HOOD
CONTACTS 9	2.08	2.66	1.65	2.18	3.37	3.69	---	1.60
15	2.69	3.63	2.20	3.03	4.70	5.13	---	1.60
25	2.50	3.25	3.00	4.42	6.23	6.84	1.25	1.25
37	4.80	7.11	4.83	6.19	9.22	10.08	---	2.95
50	6.06	9.24	---	---	---	---	---	3.50

For order instructions see "IDC Connectors" below.

RIBBON CABLE

CONTACTS	SINGLE COLOR		COLOR CODED	
	1'	10'	1'	10'
10	.50	4.40	.83	7.30
20	.65	5.70	1.25	11.00
26	.75	6.60	1.32	11.60
34	.98	8.60	1.65	14.50
40	1.32	11.60	1.92	16.80
50	1.38	12.10	2.50	22.00

IDC CONNECTORS

DESCRIPTION	SOLDER HEADER	RIGHT ANGLE SOLDER HEADER	WW HEADER	RIGHT ANGLE WW HEADER	RIBBON HEADER SOCKET	RIBBON HEADER	RIBBON EDGE CARD
ORDER BY	IDHxxS	IDHxxSR	IDHxxW	IDHxxWR	IDSxx	IDMxx	IDExx
CONTACTS 10	.82	.85	1.86	2.05	1.15	---	2.25
20	1.29	1.35	2.98	3.28	1.86	5.50	2.36
26	1.68	1.76	3.84	4.22	2.43	6.25	2.65
34	2.20	2.31	4.50	4.45	3.15	7.00	3.25
40	2.58	2.72	5.28	4.80	3.73	7.50	3.80
50	3.24	3.39	6.63	7.30	4.65	8.50	4.74

ORDERING INSTRUCTIONS: Insert the number of contacts in the position marked "xx" of the "order by" part number listed. Example: A 10 pin right angle solder style header would be IDH10SR.

VISIT OUR RETAIL STORE

HOURS: M-W-F, 9-5 T-Th., 9-9 Sat. 11-3

PLEASE USE YOUR CUSTOMER NUMBER WHEN ORDERING
TERMS: For shipping include \$2 for UPS Ground or \$3 for UPS Blue Label Air. Items over 5 pounds require additional shipping charges. Foreign orders, include sufficient amount for shipping. There is a \$10 minimum order. Bay Area and Los Angeles Counties add 6% Sales Tax. Other California residents add 6% Sales Tax. We reserve the right to substitute manufacturer. Not responsible for typographical errors. Prices are subject to change without notice. We will match or beat any competitor's price provided it is not below our cost.

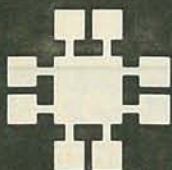

JDR Microdevices

1224 S. Bascom Ave. • San Jose, CA 95128
(408) 995-5430 • Telex 171-110

© 1983 JDR MICRODEVICES, INC.

CIRCLE 49 ON FREE INFORMATION CARD

FOR APPLE COMPUTER USERS

FD-35 DISK DRIVE

- ★ Direct Replacement for Apple Disk II
- ★ Compatible with Apple Controller or other Apple compatible controllers
- ★ Specially designed electronics with **low power consumption**
- ★ DOS 3.3 and 3.2 compatible
- ★ Owner's Manual and Warranty Card included

NOW
WITH ONE YEAR WARRANTY \$229⁹⁵
 CONTROLLER CARD \$89.95

VIEWMAX-80

A Full Function
 80 Column Card for Apple II*
 ★ Soft Video Switch ★ Shift Key Support
2 YEAR WARRANTY
 NOW ONLY \$189⁹⁵

5 1/4" DISKETTES VERBATIM DATALIFE

SS/DD SOFT SECTOR \$29.95
 SS/DD 10 SECTOR HEAD \$29.95
NASHUA
 SS/DD SOFT SECTOR
 WITH HUB RING \$19⁹⁵
BEST BUY
 Ask about our full
 line of Nashua diskettes

THOUSANDS SOLD JDR 16K RAMCARD

- ★ Expand your 48K Apple to 64K
- ★ Fully compatible with Apple Language System — Use in place of Apple Language card
- ★ Provides extra memory for Visicalc™
- ★ Run PASCAL, FORTRAN, Integer Basic with appropriate software
- ★ Highest quality card features: gold edge connector, sockets for all IC's

WITH 2 YEAR WARRANTY
 ASSEMBLED & TESTED
 WITH WARRANTY \$44⁹⁵
 KIT — INCLUDES ALL
 PARTS & INSTRUCTIONS \$40⁹⁵
 BARE PC CARD
 WITH INSTRUCTIONS \$14⁹⁵

APPLE COMPATIBLE POWER SUPPLY \$99.95

- ★ Compact Switching Design
- ★ All Outputs regulated
- ★ Short Circuit and Overload Protection
- ★ Complete with Apple-type plug-in power cord
- ★ Apple Compatible — Yet higher output allows more disk drives and cards without overheating
- ★ +5V @ .5A, +12V @ 3A, -5V @ .5A, -12V @ .5A
- ★ Shielded enclosure: 10 3/4" x 3 1/2" x 2 1/8"

NEW IMPROVED JDR COOLING FAN

- ★ Easy modification — no modification of Apple required
- ★ Eliminates overheating problems
- ★ Switch on front controls fan, Apple, and extra outlet
- ★ Rotron whisper fan is the quietest, most reliable on the market

**NOW WITH SURGE
 SUPPRESSION**
\$69.95
 WITHOUT SURGE
 SUPPRESSION \$59.95

MONITORS MONOCHROME

NEC JB1201M - 20 MHZ GREEN \$169
 ZENITH ZUM-121 - 15 MHZ GREEN \$99
 TAXAN 18 MHZ AMBER \$139
COLOR
 AMDEK COLOR I - COMPOSITE \$335
 NO C.O.D. ORDERS PLEASE

ORDER TOLL FREE
800-538-5000
800-662-6279
 (CALIFORNIA RESIDENTS)

ACCESSORIES FOR APPLE II & IIE

ALL WITH 1 YEAR WARRANTY BY



PRINTERLINK CENTRONICS PARALLEL INTERFACE

- ★ Simple to use — No configuring required
- ★ Use with any centronics printer — EPSON, OKIDATA, etc.
- ★ Includes Cable & Manual

\$59⁰⁰

MESSENGER SERIAL INTERFACE

- ★ Connects to any RS-232 serial device
- ★ 8 switch selectable drivers for printers, terminals and modems
- ★ Includes Cable & Manual

\$99⁰⁰

TIMELINK REAL TIME CLOCK

- ★ Applications in file management, word processing, communications, etc.
- ★ Exclusive Alarm Clock feature
- ★ Battery recharges automatically

\$84⁰⁰

NEW BUFFERLINK ADD-ON PRINTER BUFFER

- ★ Saves Time — No more waiting for printed output
- ★ Connects easily to any parallel interface
- ★ Expandable from 16K to 64K

\$139⁰⁰ (16K)

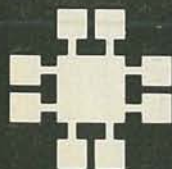

JDR Microdevices

1224 S. Bascom Ave. • San Jose, CA 95128
 (408) 995-5430 • Telex 171-110

© 1983 JDR MICRODEVICES, INC.

VISIT OUR RETAIL STORE

HOURS: M-W-F, 9-5 T-Th., 9-9 Sat. 11-3

PLEASE USE YOUR CUSTOMER NUMBER WHEN ORDERING
 TERMS: For shipping include \$2 for UPS Ground or \$3 for UPS Blue Label Air. Items over 5 pounds require additional shipping charges. Foreign orders, include sufficient amount for shipping. There is a \$10 minimum order. Bay Area and Los Angeles Counties add 6% Sales Tax. Other California residents add 6% Sales Tax. We reserve the right to substitute manufacturer. Not responsible for typographical errors. Prices are subject to change without notice. We will match or beat any competitor's price provided it is not below our cost.

TEK-EL

TECHNICAL ELECTRONICS,
YOUR SUPPLY SOURCE
WITH BARGAINS LIKE THESE:

RECHARGEABLE AA CELL

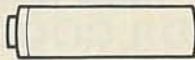

Standard AA nickel cadmium rechargeable battery.
Stock No. 16-2379 \$.95 ea.

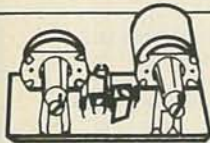

AUDIO AMP

Complete audio amp
includes volume/on-
off and tone controls.

Requires 6-9 VDC. Just the thing for PA systems,
record players, or intercoms!

Stock No. 36-3023

\$4.95 ea.

4" SOLAR CELL

1 amp at .5 volts at
an unbelievably low price!

Stock No. 47-3029 \$5.95 ea.



ORDER TODAY! VISA, MASTERCARD & COD
accepted for phone orders. Please add \$3.00
for UPS ground. Satisfaction guaranteed.
Call or write for your FREE CATALOG!

TECHNICAL ELECTRONICS

Dept. K P.O. Box 2361
Woburn, MA 01888 (617) 935-1717

CIRCLE 8 ON FREE INFORMATION CARD

A 10 HOUR TAPE RECORDER WAS \$125.00 NOW only \$95.00* LONG PLAY

Modified Panasonic Slimline
high quality AC-DC Recorder
provides 5 continuous
hrs. of recording &
play back of top qual-
ity sound on each
side of cassette for a
total of 10 hrs. Built-
in features include
• Voice level control



• Digital counter, etc.
TDK DC-180 Cassette
included.

PHONE RECORDING ADAPTER

Records calls automatically. All Solid
state connects to your telephone
jack and tape recorder. Starts
recording when phone is lifted.
Stops when you hang up.

\$24.50*
FCC APPROVED

VOX VOICE ACTIVATED CONTROL SWITCH
Solid state. Self contained. Adjust-
able sensitivity. Voices or other
sounds automatically activate and
control recorder. Uses either re-
corder or remote mike. \$24.95*

*Add for ship. & hdg. Phone Call Adapter & VOX
\$1.50 ea—Recorder \$4.00. Cal. Res. add tax. Mail
order, VISA, M/C, cod's ok. Qty. disc. avail.
Money back guar. Free data. Dir. inq. inv.
AMC SALES, Dept. A, 9335 Lubec
St., Box 928, Downey, CA
(213) 90241 Phone
869-8519

CIRCLE 51 ON FREE INFORMATION CARD

CHANEY electronics inc.

• Minimum Order \$9.00
• Please include \$1.50 for
shipping (UPS)

• We accept VISA and
MASTERCARD
• EXTRA FAST SERVICE

P.O. BOX 27038, DENVER, COLO. 80227

PHONE ORDERS: 303-781-5750

120VAC VARIABLE STROBE LIGHT KIT

Complete variable rate strobe light kit produces bril-
liant flashes of light. Operates from standard
120VAC. Reliable design—thousands of these are
in use throughout the world. Overall size of com-
pleted board: 3" L x 2" W x 3" H.

C3071 \$9.99

3VDC ELECTRONIC WARNING FLASHER KIT

This portable battery operated device continuously
emits bursts of intense light at a fixed repetition
rate. Can be seen for great distances making it a
great safety device. Features xenon flashtube. Operates
on 3VDC (two 1.5V Batteries). Size of board: 2 1/2" L x 2" W.

C3207 \$7.95

FASCINATION STAR KIT

Produces an "exploding star" visual effect using 25
LEDS and IC circuitry. The center LED lights first then
the next group of LEDS light and then another set of
lights until the outer edge of the star lights up. The
process then reverses itself. Operates from 9V bat-
tery. C4432 \$10.95

SEQUENTIAL LED FLASHER KIT

This kit combines IC circuitry and 10 jumbo red
LEDS to produce a unique visual display. LEDS
continuously light sequentially from right to left. Easy to
build kit. Operates from 9V battery. Size of board: 5.25" x 1.5".

C4431 \$6.75

MICRO-MINIATURE SPEAKER

Only 3/16" dia.
mounted on a
1" square PC
board.

C4832 \$1.49 ea.

SOLID CARBIDE PC DRILL BIT

#65 .035
Standard size for
PC boards.

C4800 \$1.49 ea.
10 for \$12.00

KESTER PC TYPE SOLDER

6 foot coil of ultra thin diameter
low melting temperature
60/40 rosin core.

C4456

\$1.00

Kits!!!

We offer over 70 complete electronic kits.
Send for our free catalog

CIRCLE 34 ON FREE INFORMATION CARD

MICROWAVE TV ANTENNA SYSTEMS

Freq. 2.1 to 2.6 GHz • 34 db Gain +



TWO YEAR WARRANTY
PARTS & LABOR

COMPLETE SYSTEMS

(as Pictured)

Commercial 40" Rod Style \$ 89.95

Parabolic 20" Dish Style \$ 79.95

COMPONENTS

Down Converters

(both types) \$ 34.95

Power Supplies

(12V to 16V) \$ 24.95

Data Info (Plans) \$ 9.95

CALL OR WRITE FOR
KITS, PARTS, INDIVIDUAL
COMPONENTS

We Repair All Types Down
Converters & Power Supplies

Phillips-Tech
Electronics

P.O. Box 34772

Phoenix, AZ 85067

(602) 265-8255

Special Quantity Pricing
Dealers Wanted

MasterCard VISA COD'S

CIRCLE 9 ON FREE INFORMATION CARD



KCS ELECTRONICS CORPORATION

SEMICONDUCTOR PARTS & PRODUCTS

FACTORY PRIME DEVICES INCLUDE:

- Capacitors
all types & styles
- Chokes & Coils
- Connectors
- Digital & Linear IC's
- Hardware & Accessories
- IC Sockets
- Memory
- Microwave Semiconductors
- Resistors
fixed & variable
- Transformers
- Transistors & MORE!

MANUFACTURERS SUCH AS: Motorola, National, NEC,
J.W. Miller, Texas Instruments and more!

WE STOCK & SUPPLY DEVICES FOR: OEM's,
Distributors, Hobbyists, Magazine Projects, Engineers,
Schools, Technicians & You!

Call or Write for Quantity Pricing
and FREE Catalog.

P.O. Box 33205 (602) 274-2885
Phoenix, AZ 85067

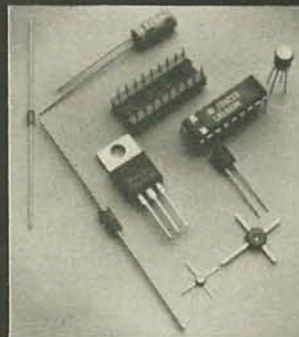

CIRCLE 83 ON FREE INFORMATION CARD



POPULAR TELEVISION CIRCUITS

SINE WAVE SUPER BOARD

- * NO Internal Connection to T.V.
- * Continuous Audio/Video Modulation
- * AGC FOR STABILITY
- * Quality Circuit Board
- * Silk Screened Parts Layout
- * Fully Illustrated Instructions
- * Quantity Discounts Available

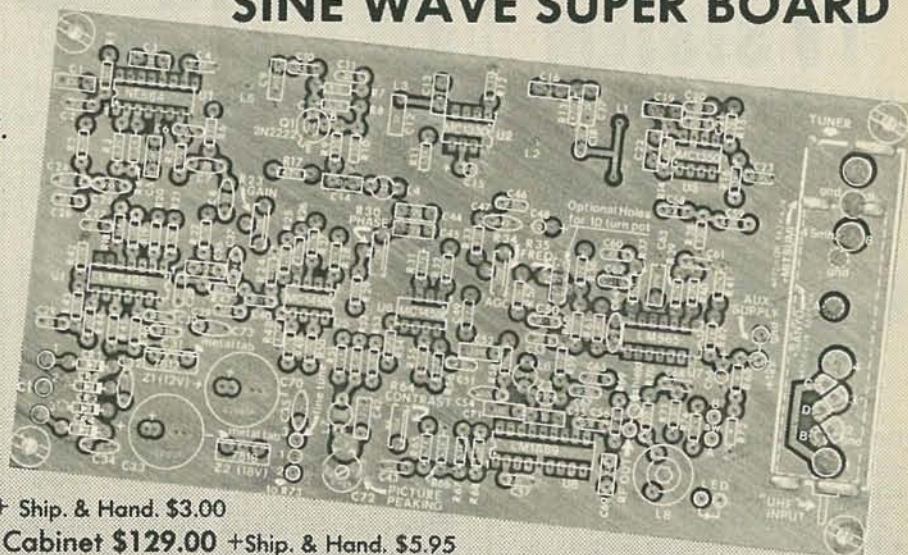

- P.C. Board and Plans \$30.00 + Ship. & Hand. \$3.00
- All Parts, and Wood Grained Cabinet \$129.00 + Ship. & Hand. \$5.95
- P.C. Board, Plans, All Parts and Wood Grained Cabinet \$149.00 + Ship. & Hand. \$5.95

ZENITH M1

09-151-03

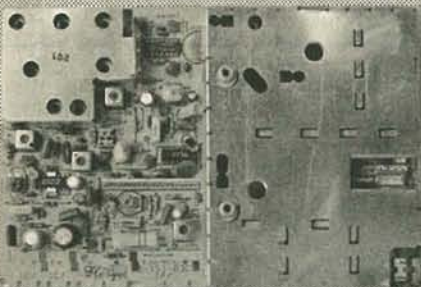

- * No Internal Connection to T.V.
- * Continuous Audio/Video Modulation
- * AGC FOR STABILITY
- * Quality Circuit Board
- * Fully Illustrated Instructions
- * Quantity Discounts Available

- FV-5 Board and Plans \$30.00 + Shipping and Handling \$3.00
- All Parts, Wood Grain Cabinet \$149.95 + Shipping & Handling \$5.95
- P.C. Board, Plans, All Parts, Wood Grain Cabinet \$169.95 + Shipping & Handling \$6.85

FV-5

Phase Video/Sync. Suppression

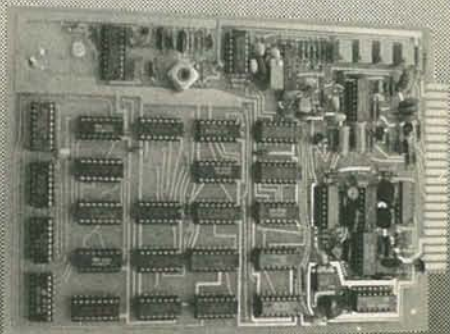

MICROWAVE PROBE KIT

P.C. Board, Microwave Transistors, All Parts and Plastic Housing

Complete \$24.95 + Shipping & Handling \$3.00

Power Supply Complete Kit \$19.95 + Shipping & Handling \$3.00



- * COMPLETE REPAIR SERVICE ON ALL ITEMS
- * AVAILABLE BY MAIL ORDER ONLY
- * SEND FOR INFORMATION ON OTHER KITS
- * HOBBY USE ONLY, NOT FOR UNAUTHORIZED RECEPTION OF T.V. SIGNALS



CERTIFIED FUNDS AND MONEY ORDERS SHIPPED IMMEDIATELY. PERSONAL CHECKS HELD FOR 3 WEEKS FOR CLEARANCE. MASTERCARD/VISA/UPS/C.O.D.



4242 South 48th Street
Phoenix, Arizona 85040

INFO PHONE: (602) 829-6700

ORDERS ONLY: (800) 243-6700

CIRCLE 13 ON FREE INFORMATION CARD

AUGUST 1983

131

HIGH QUALITY UP TO 55dB GAIN

MICROWAVE TV SYSTEM

Variable from 1.9 to 2.5 GHz



The latest advance in microwave technology with a SNOW-FREE PICTURE.

Introductory SPECIAL

\$124⁹⁵ Includes Shipping & Handling

THIS UNIT COMES COMPLETE WITH:

- 20" Fiberglass Parabolic Dish
- Pre-Assembled Probe with Down Converter
- Power Supply and Coax Switch
- 60' of RG-59/U Coax with Connector
- Transformer for 75 to 300 Ohms
- All Mounting Hardware for Fast and Easy Installation

Send Cashiers Check or Money Order to: (Personal Checks, allow 2-5 weeks to clear)

PROFESSIONAL VIDEO, Inc.
4670 Hollywood Blvd., Hollywood, Calif. 90027

For C.O.D. Orders Call (213) **219-0227**
352-9681

CIRCLE 30 ON FREE INFORMATION CARD

AMAZING DEVICES

PHASORS

PHASOR PAIN FIELD — Patented and recently developed in our labs is being tested by Gov't for riot control. Soon to come under weapons restrictions as an infernal machine. Easily hand-held. Hazardous IF NOT USED WITH DISCRETION. \$15.00

INVISIBLE PAIN FIELD GENERATOR — Produces a directional field of moderately intense pain to back of head up to 50'. Cigarette pack size enclosure is easily hidden. \$15.00

PPF-1 PLANS (sold for animal control) \$7.00

IPG-3 PLANS \$7.00 IPG-3K KIT & PLANS \$44.50

IPG-30 (assembled for animal control) \$59.50

PHASOR STUN/BURNING WAND — Produces sufficient electrical energy capable of burning flesh. Intended as a personal defense device. \$8.00 PSW-3K KIT & PLANS \$59.50

LASERS

RUBY LASER RAY PISTOL — Intense visible red, burns, hazardous, with parts sources. \$15.00

RUBY PLANS (includes all part sources) \$15.00

CARBON DIOXIDE LASER — Generates 20-40 watts of continuous power capable of burning, cutting, hazardous. (with all part sources) \$15.00

LASER RIFLE — Produces 200-3000 pulses of 30 watt optical energy. Portable and easily hand-held. \$10.00

LRG-3 PLANS \$10.00

LRG-3K KIT PLANS (minus diode) \$129.50

POCKET LASER — For the beginner, visible red "optical version", non-hazardous. \$5.00

LHC-2 \$5.00 LHC-2K KIT & PLANS \$24.50

HIGH POWERED PORTABLE ENERGY SOURCE FOR LASERS AND MAGNETIC WEAPONS — Exploding wires, shockwave, etc. Miniature size. \$49.50

HPS-1 PLANS \$8.00 HPS-1K KIT & PLANS \$49.50

PARTICLE BEAM WEAPON — PLANS \$15.00

SECURITY

INFINITY XMTR — Uses telephone lines for selective home or office listening while away on business or vacation. \$15.00

INF-1 PLANS \$15.00

SEE IN DARK — Long range, total darkness. \$10.00

SD-4 PLANS \$10.00

LONG RANGE WIRELESS MIKE — Crystal clear quality — miniature. \$7.00

FBT-7 PLANS \$7.00 FBT-7K KIT & KIT \$34.50

WIRELESS TELEPHONE TRANSMITTER — Long range, automatic. \$10.00

VWPM-5 PLANS \$10.00 VWPM-5K PLANS & KIT \$34.50

Send for FREE catalog description of above plus hundreds more plans, kits and completed items. We accept MC or Visa or when ordering, send check or money order. We pay shipping charges on orders over \$50.00, otherwise include 10% with remittance.

SEND TO: **SCIENTIFIC SYSTEMS**

DEPT. R8, BOX 716, AMHERST, N.H. 03031

CIRCLE 50 ON FREE INFORMATION CARD

THE WORLD FAMOUS **ETCO** CATALOG OF ELECTRONICS

FREE **LOW PRICES**

• VIDEO
• TELEPHONE
• CABLE TV
• PARTS
• AUDIO
• ELECTRONICS
• and much, much more!

1000's OF FASCINATING FACTORY CLEAROUTS, SURPLUS SPECIALS AND BARGAIN OFFERS NOT FOUND IN STORES OR CATALOGS ANYWHERE!

NOW 112 PAGES

ETCO ELECTRONICS DEPT. 591
Mailing List Control Center
Box 840
Champlain, N.Y. 12919

I Enclose _____ (cash OK);
Please rush postpaid

\$1 for 1 year subscription to the world famous ETCO catalog.
 \$3 Canadian & Foreign 1 year subscription to the ETCO catalog.
 304 page handbook "BUILD YOUR OWN EARTH STATION". (TA025) \$10.00
 360 pages MASTER HANDBOOK OF TELEPHONES. (TA001) \$11.00
 FREE - sample copy of the bargain packed ETCO catalog. (USA only)

Name _____
Address _____
City _____
State _____ Zip _____

CIRCLE 50 ON FREE INFORMATION CARD

TOTAL ELECTRONICS CENTER • LOWER PRICES • IMMEDIATE DELIVERY

DISCOUNT TEST EQUIPMENT

FLUKE

HAND HELD DMM's



8062A \$244 **8024B \$217**

- 4 1/2 Digit • Full Functions And Ranges • True RMS to 30 kHz • 0.05% DC Accuracy
- 3 1/2 Digit • 11 Functions • 0.1% DC Accuracy • Safety Designed Test Leads



BBC

FOLDING MULTIMETERS



MA 3E M 2032 \$164 **\$220**

- Analog Display • Ranges • 100mm Mirror Scale • Accuracy 1.5% DC, 2.5% AC • Input Impedance 10MΩ
- 3 1/2 Digit LCD Display • True RMS • 31 Ranges • Diode Test/Audio Cont. • More



B & K

OSCILLOSCOPES



1479BP \$673
Dual Trace 30 MHz Triggered • 11.7ns Rise Time • 5mV/cm Vertical Sensitivity • Probes • More



1405 \$259
5 MHz 3" Scope • 10mV/Division Vertical Sensitivity • More

SOAR CORP.

150MHz FREQUENCY COUNTER



FC-845 \$149

Measures 5Hz To 150MHz • 2 Ranges • Sensitivity 30mV • CRYSTAL CONTROLLED • 0.01 Sec and 1 Sec Gate Time • Battery or AC • 1 1/4" x 4" x 4 1/4" • Includes Probes & Battery

KEITHLEY

THERMISTOR THERMOMETER



865/866

Greater Accuracy To As Low As 10°C • 0.1° Resolution • Sustains 6' Drop • Lightweight

865 °F \$122 each

866 °C

GLOBAL SPECIALTIES

LOGICAL ANALYSIS TEST KITS



LTC-1 \$198

LTC-2 \$223

Include Digital Pulser • Logic Monitor • Logic Probe • Probe Tips (4) • Quick Hook Jumper • Adapters • Instructions • Carrying Case and More.

Over 70,000 Electronic Items
Same Day Shipment



WM. B. ALLEN SUPPLY
1601 Basin Street, New Orleans, LA 70116

800 535-9593

Louisiana Only Toll Free
800 462-9520



CIRCLE 26 ON FREE INFORMATION CARD

ELECTRONIC KITS FROM HAL-TRONIX

2304 MHZ DOWN CONVERTERS. TUNES IN ON CHANNELS 2 TO 7 ON YOUR OWN HOME T.V. HAS FREQUENCY RANGE FROM 2000 MHZ TO 2500 MHZ. EASY TO CONSTRUCT AND COMES COMPLETE WITH ALL PARTS INCLUDING A DIE-CAST ALUM CASE AND COAX FITTINGS, REQUIRE A VARIABLE POWER SUPPLY AND ANTENNA (Antenna can be a dish type or coffee can type depending on the signal strength in your area.)

- 2304 MOD 1 (Basic Kit) \$19.95
(Less case & fittings)
- 2304 MOD 2 (Basic Pre-amp) \$29.95
(less case & fittings)
- 2304 MOD 3 (Hi-Gain Pre-amp) \$39.95
(Includes case & fittings)
- POWER SUPPLY FOR EITHER MODEL ABOVE IS AVAILABLE. COMES COMPLETE WITH ALL PARTS, CASE, TRANSFORMER, ANTENNA SWITCH AND CONNECTORS (KIT) \$24.95 Assembled.....\$34.95
Slotted Microwave Antenna For Above Downverters.....\$39.95

PREAMPLIFIERS

HAL PA-19—1.5 mhz to 150 mhz. 19db gain operates on 8 to 18 volts at 10ma. Complete unit \$8.95.
HAL PA-14—3 mhz to 1.4 ghz. 10 to 12 db gain operates on 8 to 18 volts at 10 ma. Complete unit \$12.95.
(The above units are ideal for receivers, counters, etc.)

- 16 LINE TOUCH TONE DECODE KIT WITH P.C. BOARD AND PARTS.....\$69.95
- 12 LINE TOUCH TONE DECODER KIT WITH P.C. BOARD AND PARTS.....\$39.95
- 16 LINE ENCODER KIT, COMPLETE WITH CASE, PAD AND COMPONENTS.....\$39.95
- 12 LINE ENCODER KIT, COMPLETE WITH CASE, PAD AND COMPONENTS.....\$29.95

Complete Sets of P.C. Boards Available For: Unicorn Robot Project and Heart-A-Matic Project.
MANY, MANY OTHER KITS AVAILABLE

Send 20 cents stamp or S.A.S.E. for information and flyer on other HAL-TRONIX products. To order by phone: 1-312-285-1782.



HAL-TRONIX
P.O. Box 1101
Southgate, MI 48195

SHIPPING INFORMATION: ORDERS OVER \$25.00 WILL BE SHIPPED POSTPAID EXCEPT ON ITEMS WHERE ADDITIONAL CHARGES ARE REQUESTED. ON ORDERS LESS THAN \$25.00 PLEASE INCLUDE ADDITIONAL \$2.00 FOR HANDLING AND MAILING CHARGES.

CIRCLE 75 ON FREE INFORMATION CARD

TUSA
A WHOLE NEW WORLD OF TV VIEWING WITH TUSA'S NEW MODEL CVU-45, 45 CHANNEL CABLE TV CONVERTER. Receive all the EXTRA CABLE TV "MIDBAND" & "SUPERBAND" CHANNELS on your UHF DIAL.
Eliminates the need for renting or leasing. This system takes the "midband" and "superband" channels your TV, VCR or projector can't receive and converts them to standard UHF channels that any set can tune in.
A MUST FOR VIDEO-TAPING FROM CABLE TV!
The system allows you to program both pay (pay) TV decoder required and standard cable channels for taping on any VCR — while you are watching a different channel on your TV.
Simple to install and operate on any make of TV with UHF.
Now **\$28.95 ea.** PLUS POSTAGE

NEW TUNEABLE DELUXE MODEL CVU-1000 \$34.95 ea.

UHF TUNERS
Continuous Tune Model
45MHz Output

While They Last

\$3.50 ea.
5 or more \$2.25 ea.

POPULAR IC's
NO SECONDOS

TYPE	DESCRIPTION	1-8	10-UP
LM-300N	2 watt Audio Power Amp	\$1.49	\$1.12
LM-308N-3	Low Voltage Audio Amp	1.19	1.19
NE-564N	2000HzV	3.50	2.09
LM-565N	Digital Phase Locked Loop	1.49	1.12
LM-733N	Phase Locked Loop	1.69	1.27
MC-1330	Video Detector	2.49	1.87
MC-1349	Video IF Amp	2.09	1.55
MC-1350	Video IF Amp	1.75	1.31
MC-1352	Video IF Amp AGC	2.69	2.09
MC-1358	Audio IF Amp	1.95	1.40
MC-1374P	R.F. Modulator	3.19	2.39
MC-1458	Dual Comp. Op Amp	86	66
MC-1499N	Balanced Mod/Demodulator	1.79	1.34
LM-1800	PLL Stereo Decoder	2.29	1.99
LM-1889	Video Modulator	2.79	2.18
LINEAR VOLTAGE REGULATORS			
LM-7905	5 Volt Positive Volt. Reg.	1.19	.89
LM-7905	5 Volt Positive Volt. Reg.	1.19	.89
LM-7812	12 Volt Positive Volt. Reg.	1.19	.89
LM-7815	15 Volt Positive Volt. Reg.	1.19	.89
LM-7818	18 Volt Positive Volt. Reg.	1.19	.89
LM-7824	24 Volt Positive Volt. Reg.	1.19	.89

WINEGARD
75 OHM UHF YAGI ANTENNAS

12 db GAIN
SPECIFY CHANNEL \$8.95 ea.
6 OR MORE \$6.95 ea.
OPTIONAL Winegard UHF Antenna Preamp 18db Gain \$39.95 ea.

Now Back in Stock!
SANYO UHF VARACTOR TUNERS
45 MHz Output

\$19.95 EACH

Call for Quantity Price

AC LINE CORDS
18 gauge wire
6 ft. long cable
Prestripped and tinned ends for easy installation.

49¢ ea.
AC-6G 12-Up 39¢ ea.

SPEAKER CABINET
Popular speaker cabinets for those famous homebrew TV circuits.
Speakers included.
Dimensions: 7 1/2" wide x 9 1/2" high x 5 1/2" deep. Removable 1/8" thick back cover.
SC001 \$10.95 ea.
2 or more \$8.95 ea.

VCR-TV 10db VHF/CABLE/FM SIGNAL AMPLIFIER
#M01 50-400 MHz. This one really works! Boosting those weak VHF FM, midband & superband cable channels. Standard F connectors for 75 ohm input/output.
\$19.95 ea. 4 or more \$8.95 ea.

Special Purchase
MV-2109
33pf Tuning Diode
1-9 \$1.09 ea.
10-Up \$0.99 ea.

5% MICA CAPS 5%
10pf .42¢ ea. 500pf .66¢ ea.
45pf .30¢ ea. 1200pf .89¢ ea.
110pf .35¢ ea. 3000pf 1.39¢ ea.
Call for Quantity Discount

POPULAR MICROWAVE PARTS
MRF-901 \$2.39
9-Up 1.95
MRF-911 3.48
9-Up 3.12
MBO-101 .98
CHIP CAPS: .001 mfd .50
25-Up .30
2N5603 (formerly MRF-902) 11.99

75 OHM CHASSIS MOUNT CONNECTOR
F-81 Female connector. Rear chassis mount with nut. Mates with male "F" connectors.
NOW! 4 for \$1.00

Actual unit may differ from that shown.
While They Last! \$13.95 ea.

DELUXE A-B SWITCHES
Specify Pushbutton or lever type
For CATV - MATV - VCR
75 ohm - 90 db Isolation
\$6.95 ea.

POPULAR MISCELLANEOUS PARTS
IN4001 Diodes 15 for \$1.00
100 for \$5.00
1/4 W 10K Thumbwheel pots 1-12 \$3.00
13-Up \$2.39
Toroids - T30-12 .46
20-Up \$2.25
Toroids - T37-2 .38
20-Up \$2.25

PROJECT BOXES
Woodgrain
This box is 11 1/4" W - 4 1/2" H - 6 1/2" D with a removable aluminum U-shaped chassis 11" W - 3 1/2" H - 6" D inside.
\$12.50 ea.
\$10.95 ea.
4 or more \$9.95 ea.
For Larger Quantities - CALL

UHF - VHF - FM 2-WAY SPLITTER
75 Ohm
40-900 MHz
Model PM-1030
Low Loss 3.5-4 db. Low VSWR
Waterproof 1-9 \$1.98 ea.
Housing 10-Up \$1.59 ea.

ORDER NOW
TOLL FREE
800-854-4655
OUTSIDE CALIFORNIA
714-635-5090
INSIDE CALIFORNIA

R.F. ELECTRONICS
1056 N. STATE COLLEGE BLVD., DEPT. R
ANAHEIM, CALIFORNIA 92806

PERSONAL CHECKS HELD FOR CLEARANCE — NO MINIMUM ORDER
ALL PREPAID ORDERS 2 LBS OR LESS MUST INCLUDE \$2.50 SHIPPING & HANDLING — SHIPPED SAME DAY RECEIVED

OPEN TUES - FRI 10-6
SAT 10-5
CLOSED SUN & MON

SEND FREE Mail Order Catalog

CIRCLE 27 ON FREE INFORMATION CARD

POPULAR CHIPS

LM 301	.39
LM 380	1.25
LM 386	.79
NE 564	2.50
LM 565	.89
MC 1330	1.10
MC 1350	1.00
MC 1358	1.10
MC 1458	.49
MC 1496	1.50
LM 1889	1.95
7808	.75
7812	.75
7815	.75
7818	.75
MV 2109	.69
2N2222A	.30
MC1349	1.39

CHOKES

.37 uh	33 uh
.47 uh	100 uh
15 uh	10 mh
18 uh	69¢ each

VARI CAPS

10 - 60 pf	69¢ each
30 - 90 pf	69¢ each

MITSUMI UES A55F VARACTOR TUNER
CHAN. 14-83
400 ohm INPUT \$17.95

DELUXE PARTS ASSORTMENTS

#1 Resistors & Trimpots
68 1/2 watt, 5% resistors & 5 PT-15 10K trimpots. 1 each - 51, 75, 100, 470, 1.5K, 3.6K, 51K, 470K, 13-1.2K, 2-220, 3-100K, 6-330, 6-12K, 7-910, 9-3.3K, & 14-4.7K.
\$5.25 each

#2 Capacitor "A"
Monolythics - 1-560pf, 7-1 mfd, & 1-22 mfd.
Silver Micas - 2-10pf, & 1 each of 43pf, 110pf, 560pf, 1200pf, 3000 or 3300pf.
\$5.95 each

#3 Capacitor "B"
Mylars 4-001, 2-.047, 29-.01. Radial lytics 3-10 mfd 18V, 1-1000 mfd 50V, 1-2200 mfd 35V.
Disc Caps 1 each of 5, 12, 27, 36, 110, 330pf, 2-120pf, 3-39pf, 3-220pf, and 1 Vari Cap 5-35pf.
\$7.50 each

#4 Coil & Chokes
1 each of 15, 33, and 100 (uh) micro henries
chokes: 1-variable RF coil (same as #4) #9A537MPC)
\$3.25 each

#5 IC's, Sockets, & Semi's
1 each of: NE564, LM565, MC1330, MC1350, MC1496, LM1889, 7812, 7818, 2N2222A, MV2109, heat sink 2-MC1458, 4-1N4002, 4-8 pin, 2-14 pin, 1-16, & 1-18 pin socket.
\$13.25 each

#6 Misc. Hardware
LED & holder, fuse & holder, line cord, grommet, SPST switch, DPDT switch, 2-F61 conn. & lugs, knob, 4-spacers, 6-screws & nuts, 2-RG-174, matching transformer w/nut.
\$5.95 each

METAL BOX—PRE-DRILLED
DIM: 10" W x 4 1/2" x 3" High
HOLES: 4% in back, 1% in front
2 1/4" in front, 6 #6 on bottom
PAINTED \$10.95 ea., 10/\$99.50
25/\$223.75

NETWORK SALES, INC.

RIBBON CABLE CONNECTOR
These very popular 40 PIN ribbon cable connectors are used by a number of mfgs. of micros for internal board to board terminations and I/O port connections.
W/strain relief \$2.50

40 CONDUCTOR RIBBON CABLE
gray color 70¢/ft.

MINI FAN 3.125" SQ.
40 CMF
115VAC-60hz
REMOVED FROM NEW EQUIP.
TESTED \$6.95

S-100 CONNECTOR
SOLDER TAIL
GOLD PLATED
\$3.50 ea.
10 @ \$32.50

THUMBWHEEL TRIMMER POTS
VERTICAL MOUNT
OHMS 500, 1K, 2K, 5K, 10K, 25K
50K, 100K, 200K, 500K, 1 MEG.
4/\$1.00 100/\$20.00

3/8" SQ. TRIM POTS
TOP ADJUST
1K 10K
5K 20K 79¢ ea.

SOLID CARBIDE PC DRILL
#55 1/8 in. SHANK FOR USE WITH DREMEL TOOL
\$1.00

DIP SWITCHES
High quality DIP switches mfg. by CTS. Available in the following configurations.
4 POS—80¢ 6 POS—80¢
5 POS—80¢ 7 POS—80¢

DB-25 S (FEMALE)
The most popular computer connector. Mfg. by AMP. .025" gold PC pins with mfg. holes.
\$1.95

RELAY 4PDT 120 VAC COIL PLASTIC ENCLOSED \$3.50 ea.
5 AMP CONTACTS
SOCKETS 85¢

THUMBWHEEL SWITCH
\$7.95 BCD 0-9 W/COMPLIMENT (EACH DIGIT ILLUMINATED W/LED)
4 DIGIT W/END PLATES FOR EASY MTG.

DIP RELAYS
SPST (N.O.) 12 VOLT \$1.25
SPDT 5 VOLT (W/CLAMP DIODE) \$1.75

RF COIL
Same as #9A537MPC
\$1.50 ea. 10/\$12.50

NETWORK SALES, INC.
2343 W. BELMONT AVE.
CHICAGO, IL. 60618
312-248-3202

TERMS: Visa, M.C., Check, Money Order or COD (add \$3.00). Min. Order \$10.00. Add \$2.50 S&H for USA. Ill. add 7% Tax. MAIL ORDER ONLY.
Prices subject to change without notice.
Phone Orders Welcome.
WRITE FOR OUR MONTHLY UN-ADVERTISED SPECIALS

©COPYRIGHT 1983 NETWORK SALES, INC.

MORE GAIN

Than a Varactor UHF Tuner

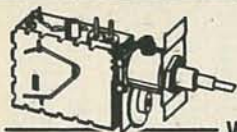

\$15⁰⁰ SATISFACTION GUARANTEED
 Frequency Range 470-899 MHz Channels
 14-83. Output Channel 3. Ch 2 or 4 Avail.
PART #B20 **\$15⁰⁰**
WHAT'S IN IT?

To make a regular UHF tuner into a **GILCO HIGH GAIN TUNER**, each and every one of the following steps is painstakingly taken by a certified technician:

1. The first thing GILCO does is change the standard diode to a **hot carrier diode**.
2. The tuner's output is then measured on our JERROLD field strength meter and compared to a computer derived chart from which we determine the correct value coil to add across the IF output for **maximum pre-peaked gain**.
3. The tuner is then fed a standard 10db 300 ohm antenna input and while monitoring the output on our HEWLETT PACKARD spectrum analyzer, the tuner is tuned to the desired channel and its oscillator is offset for the desired output frequency as follows:
 Channel 2: 58 Mhz, Channel 3: 63 Mhz, Channel 4: 68 Hhz

We call this step peaking because the tuner's output looks like a peak on our spectrum analyzer and the highest point of that peak is actually adjusted for the desired output.

4. The last step is one more measurement on the field strength meter which is again compared to our performance chart to calculate the correct value of the second coil which is added to the tuners internal connections.

This procedure was developed by GILCO and it is our computer derived performance charts that make our tuner better, that's because **almost every tuner gets a different value coil** before it's peaked and again a different value coil after it's peaked. The combinations are endless and **the way we determine the values is our secret...**

GILCO PARTS KIT & PRINTED CIRCUIT BOARD

- Use with GILCO High Gain Tuner
- Requires NO Modification to Your Television
- Individually Packaged and Labeled Parts Save Guesswork

The only tools required for assembly are: screwdriver, soldering iron, voltmeter. No drilling is required to the P/C board.

This kit was designed to take advantage of the GILCO high gain tuner which means its circuitry is **simpler and more efficient** than those circuits that require inferior varactor tuners.

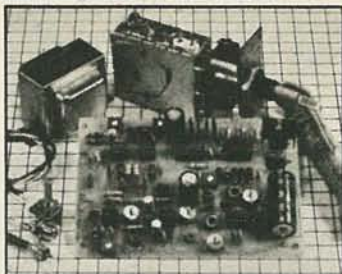

Pre-drilled, pre-screened, plated through the holes P/C board. All hardware, connectors, 22 page illustrated instruction manual, & Gilco Hy-Gain tuner. Kit assembles in just 4 hours.

FREE 22 Page Instruction Book included with each P/C Board or Parts Kit. This instruction book will guide the builder through every step of the assembly. **Nearly every page is illustrated.** With this Instruction Book, estimated assembly time is 4 hours.

HERE'S WHAT YOU GET FROM GILCO **\$17⁰⁰**

- Part No. B21 Printed Circuit Board** **\$17⁰⁰**
1. This Printed Circuit Board uses **only one jumper, others use nine.**
 2. **The component layout is screen printed** on the component side of the P/C board.
 3. The solder side of the P/C board is covered with high temperature solder
 4. **Newest Addition:** the P/C board is **plated through the holes.** This allows for easier and more positive soldered contact between the parts and the P/C board.

Part No. B22 Complete Electronic Parts Kit **\$80⁰⁰**

All resistors (30), Potentiometers (1-5K, 3-10K), Panel Mount Potentiometer (10K), Electrolytic Capacitors (6), Ceramic and Mylar Disc Capacitors (35), Variable Capacitors (4), All Integrated Circuits (7), Voltage Regulator, Heat Sink, Diodes (4), IC Sockets (4-8 pin, 3-14 pin), Power Transformer (24V, 1A), Coil Kit with No. 26 wire (4), Speaker (4" 3oz.), Standoffs, Coaxial Cable, All Miscellaneous Hardware, Etc. All parts are individually packaged and labeled.

All components including the Wire, Hardware, Coaxial Cable and Heat Sinks are included in the parts kit. This means your assembly time from start to finish is just 4 hours.

GILCO ACCESSORIES & AMPLIFIER KITS

- #A02 New 2 stage, low noise, 28db gain, RF Amplifier Kit Kit **\$18⁰⁰**
 #A03 New 1 stage, low noise, 14db gain, RF Amplifier Kit Kit **\$10⁵⁰**

GILCO ORDER FORM

#B20 GILCO Hy-Gain Modified Tuner	\$15 ⁰⁰
#B21 GILCO Predrilled, Screen Printed, Circuit Board	\$17 ⁰⁰
#B22 GILCO Parts Kit (Less P/C Board)	\$80 ⁰⁰
#B20, B21, B22 Complete P/C Board and Parts Kit (all three)	\$110 ⁰⁰
#A02 Two stage, 28 db gain, Amplifier Kit	\$18 ⁵⁰
#A03 One stage, 14db gain, Amplifier Kit	\$10 ⁵⁰
Name	Total
Address	Tax
City	State
Zip	Shipping
	Total

Mail Order Only. Send check or money order to:
GILCO INTERNATIONAL, INC.
 P.O. Box 8817, Coral Gables, Florida 33124

CALL (305) 823-5891 for COD orders **PLEASE WRITE FOR OUR FREE CATALOG**
 Shipping Orders under \$50 add 10%, Orders over \$50 add 5%, FL residents +5% Tax

CIRCLE 84 ON FREE INFORMATION CARD

PROFESSIONAL TECHNICIANS & SERVICEMEN

WE CAN SUPPLY ALL THE COMPONENTS FOR YOUR MAINTENANCE, REPAIR & DESIGN WORK

REPLACEMENT FOR ECG® TYPES (Min. 5 pcs. each type)

TYPE NO.	YOUR PRICE	TYPE NO.	YOUR PRICE	TYPE NO.	YOUR PRICE
85	.30	152	.40	375	.99
123A	.25	153	.40	500A	8.95
124	.95	154	.65	523	10.20
128	.45	165	2.25	526A	10.75
129	.45	238	2.25	712	1.25
130	.85	291	.99	852	4.95

SUPER SPECIAL (Min. 5 pc. each)

TYPE NO. YOUR PRICE
276 6.95 EXACT REPLACEMENT FOR **SG613H**
2SC1172B 100 PCS. FOR 1.60 EACH

SPECIAL JAPANESE TYPES (Min. 5 pcs. each)

2SC867A	2.75	AN214Q	1.45	UPC1181H	1.25
2SC1172B	1.95	M51515BL	2.95	UPC1182	1.25
2SC1308K	1.95	TA7205AP	1.25	STK435	3.95

FOR A COMPLETE 1983 COMPONENT CATALOG CALL OR WRITE

CALL TOLL FREE **800-526-4928**
 IN NEW JERSEY (201) 379-9016

COD ORDERS WELCOME (\$25 Min. Order)

DIGITRON ELECTRONIC

110 Hillside Avenue, Springfield, N.J. 07081

*ECG IS A TRADE MARK OF PHILIPS ECG
 DIGITRON ELECTRONIC IS NOT ASSOCIATED IN ANY WAY WITH PHILIPS ECG.

CIRCLE 11 ON FREE INFORMATION CARD

Computer Products & Unlimited

18 GRANITE STREET • HAVERHILL, MASS. 01830

617/372-8637

CLOSEOUT SUPER BUY!

SHUGART SA-1004



Winchester 8" diskette sized with a whopping 10 Mbyte (8 bytes formatted). Removed from USED Equipment (for replacement with higher density drives). But we cannot test them, hence our low price.

\$595⁰⁰

WINCHESTER DRIVES

ST-506 Mini-Wini- "UNUSED" 5 Mbytes with industry standard interface, Seagate technology ST-506, 5 1/4" size Winchester Drive



\$549⁰⁰

CDC 9427-H "HAWK"

12 Mbyte (10 Mb formatted) "Cartridge" Disk Drives



Industry standard 5440 type Disk Drives with User Set Sector Counts, 2400 RPM, 200 TPI capability, Diablo type interface. Removed from systems upgraded to higher density... Probably operational but no time to test them.

\$995⁰⁰

Add \$30.00 for shipping crate

CIRCLE 58 ON FREE INFORMATION CARD

Electronics Paperback Books

Quality Paperbacks at Affordable Prices



- 30 SOLDERLESS BREADBOARD PROJECTS BOOK-1.** \$5.75. Whenever possible the same parts are used in several projects. Even a first-time builder can complete these circuits.
- HOW TO GET YOUR ELECTRONIC PROJECTS WORKING.** \$5.00. Helps you troubleshoot and repair home-built projects of every description.
- MINI-MATRIX BOARD PROJECTS.** \$5.00. A variety of projects that can all be built upon a mini-matrix board that has 10 strips and is 24 holes long.
- MODERN OP-AMP PROJECTS.** \$5.00. Wide range of specialized op-amp circuits including io-noise, io-distortion, ultra-hi input impedance, etc.
- MULTI-CIRCUIT BOARD PROJECTS.** \$5.00. 21 fairly simple projects that can all be built on a single printed-circuit board. All are powered by a 9V battery.
- IC PROJECTS FOR BEGINNERS.** \$5.00. Inexpensive digital and linear ICs are used to assemble this selection of circuits intended for the beginner.



- ART OF PROGRAMMING THE 1K ZX81.** \$6.25. Topics include full screen, scrolling, PEEK & POKE, plus actual working programs.
- THE 6809 COMPANION.** \$5.00. Written for the average assembly language programmer. A discussion of 6809 features & reference work for the 6809 programmer.
- PRACTICAL COMPUTER EXPERIMENTS.** \$4.50. Fills in background to microprocessor by constructing typical computer circuits using discrete logic components.
- ART OF PROGRAMMING THE 1K ZX81.** \$5.00. How to use the features of the ZX81 in programs that fit the 1K machine and are still fun to use.
- INTRODUCTION TO BASIC PROGRAMMING TECHNIQUES.** \$5.00. Based on author's own experience in learning BASIC and helping others to learn to program.
- A MICROPROCESSOR PRIMER.** \$4.50. Painless approach to computing for the beginner. Step-by-step explains computer operations and assembly.



- THE PRE-COMPUTER BOOK.** \$5.00. Aimed at the absolute beginner with no knowledge of computers. A non-technical discussion that helps you enter the computer world painlessly.
- AN INTRODUCTION TO VIDEO.** \$5.00. Perfect for the person just about to buy a VCR. Discusses pros & cons of the various formats; video discs; videotext; tape copying and more.
- PRACTICAL ELECTRONIC BUILDING BLOCKS—Book 1.** \$5.00. All electronics circuits consist of simple building blocks. When you know how to make the blocks you can easily create your own projects.
- FIRST BOOK OF TRANSISTOR EQUIVALENTS, & SUBSTITUTES.** \$3.75.
- PRACTICAL COMPUTER EXPERIMENTS.** \$4.50.
- ELECTRONICS SIMPLIFIED CRYSTAL SET CONSTRUCTION.** \$4.50.
- ELECTRONIC HOUSEHOLD PROJECTS.** \$4.50.

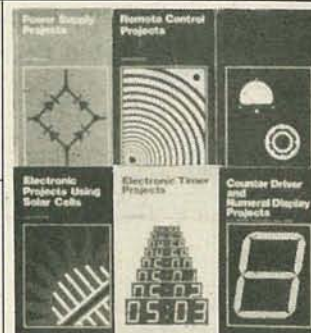

- POWER SUPPLY PROJECTS.** \$4.50. Contains designs and construction details for almost any power supply the experimenter is likely to need.
- REMOTE CONTROL PROJECTS.** \$5.00. Radio-control infra-red, visible light, & ultrasonic systems are all included, along with methods of applying them.
- ELECTRONIC TEST EQUIPMENT CONSTRUCTION.** \$4.50. Construction details of a wide range of test equipment the experimenter can build at home.
- ELECTRONIC PROJECTS USING SOLAR CELLS.** \$5.00. Simple circuits that have numerous applications around the home.
- ELECTRONIC TIMER PROJECTS.** \$5.00. Timing circuits for almost any application the experimenter might need. A most valuable reference.
- COUNTER DRIVER & NUMERICAL-DISPLAY PROJECTS.** \$4.50. Features applications & projects using various types of numerical-display devices.



- PRACTICAL ELECTRONICS CALCULATIONS AND FORMULAE.** \$7.50. A basic reference work that bridges the gap between complicated technical theory & cut and tried methods.
- INTERNATIONAL DIODE EQUIVALENTS GUIDE.** \$5.75. Helps you find substitutes for the many different types of semiconductor diodes in use today.
- INTERNATIONAL TRANSISTOR EQUIVALENTS GUIDE.** \$7.50. Products of more than 100 manufacturers are listed & cross-referenced with possible replacements.
- HOW TO MAKE WALKIE TALKIES.** \$5.00. Describes equipment for low-power handheld operation. 112 pages of must reading for the dedicated experimenter.
- ELECTRONIC CALCULATOR USERS HANDBOOK.** \$3.95. Presents formulae data, methods of calculation, conversion factors & more from the view of the calculator user.
- LINEAR IC EQUIVALENTS AND PIN CONNECTIONS.** \$8.25. Shows equivalents & pin connections of a popular user-oriented selection of linear ICs.



- ELECTRONIC SYNTHESIZER PROJECTS.** \$4.50.
- 50 CIRCUITS USING GERMANIUM, SILICON & ZENER DIODES.** \$3.75.
- 50 PROJECTS USING RELAYS, SCR'S & TRIACS.** \$5.00.
- 50 (FET) FIELD-EFFECT TRANSISTOR PROJECTS.** \$4.50.
- 50 SIMPLE LED CIRCUITS.** \$4.25.
- 50 CIRCUITS USING 7400 SERIES IC'S.** \$4.50.
- 50 SIMPLE LED CIRCUITS BOOK 2.** \$3.95.
- PROJECTS USING 555 IC'S.** \$5.00.
- PROJECTS USING LM3900 IC'S.** \$4.75.
- RADIO CONTROL FOR BEGINNERS.** \$4.50.
- ELECTRONIC GAMES.** \$4.50.
- SINGLE IC PROJECTS.** \$4.25.
- RADIO CIRCUITS USING IC'S.** \$4.50.
- ELECTRONIC PROJECTS FOR BEGINNERS.** \$5.00.
- ELECTRONIC MUSIC & CREATIVE TAPE RECORDING.** \$5.00.
- ELECTRONIC SECURITY DEVICES.** \$5.00.
- HOW TO BUILD YOUR OWN SOLID-STATE OSCILLOSCOPE.** \$5.00.
- SECOND BOOK OF CMOS IC PROJECTS.** \$4.25.
- PRACTICAL CONSTRUCTION OF PRE-AMPS, TONE CONTROLS, FILTERS AND ATTENUATORS.** \$3.75.
- BEGINNERS GUIDE TO DIGITAL TECHNIQUES.** \$3.75.
- ELECTRONIC HOUSEHOLD PROJECTS.** \$4.50.
- ELECTRONIC MUSIC PROJECTS.** \$4.50.
- POPULAR ELECTRONIC PROJECTS.** \$3.75.
- PROJECTS IN OPTO-ELECTRONICS.** \$5.00.



- ANTENNA PROJECTS.** \$5.00. Covers practical antenna designs including active, loop & ferrite types that are easy & inexpensive to build.
- RADIO STATIONS GUIDE.** \$4.75. Comprehensive listing of transmitters around the world. Presents location, frequency, power.
- LONG DISTANCE TV RECEPTION (TVDX) FOR THE ENTHUSIAST.** \$5.00. Practical & authoritative introduction to this unusual aspect of electronics.
- CB PROJECTS.** \$5.00. A number of useful and interesting designs for CB accessories. Speech processor, interference filter & more.
- CRYSTAL SET CONSTRUCTION.** \$4.50. Packed full of easy to duplicate designs for crystal radio receivers.
- AN INTRODUCTION TO RADIO DXING.** \$5.00. Listen, in your home, to broadcasts originating thousands of miles away. Tells how you can do it.

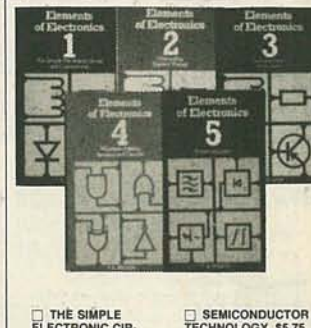

- THE SIMPLE ELECTRONIC CIRCUIT & COMPONENTS.** \$5.75. All the fundamental theory needed to lead to a full understanding of the simple electronic circuit and its components.
- ALTERNATING CURRENT THEORY.** \$5.75. Alternating current theory without which there can be no comprehension of speech, music, radio, or Television.
- MICROPROCESSING SYSTEM & CIRCUITS.** \$7.50. A truly comprehensive guide to all of the elements of a microprocessing system.
- 28 TESTED TRANSISTOR PROJECTS.** \$4.25.
- SEMICONDUCTOR TECHNOLOGY.** \$5.75. Everything you always needed to know about solid-state devices in one volume.
- COMMUNICATIONS.** \$7.50. Covers most modern communication systems. Line, microwave, submarine, satellite, digital multiplex, radio & telegraphy.
- FIRST BOOK OF HI-FI SPEAKER ENCLOSURES.** \$4.50.
- SOLID STATE NOVELTY CIRCUITS.** \$3.50.

ELECTRONIC TECHNOLOGY TODAY INC.
P.O. Box 83, Massapequa Park, NY 11762

Number of books ordered

Total Price of Books\$

Sales Tax (NY State Residents)

Shipping (75¢ 1st two books, 30¢ ea additional)

TOTAL ENCLOSED\$

Name

Address

City State ZIP

Prices good until August 30, 1983

SPARTAN Electronics Inc.



CALL (516) 499-9500
6094 Jericho Tpke.
Commack, N.Y. 11725

CTC9R

Philips Remote Cable Converter



• Micro computer technology • Quartz controlled IC's lock in picture & prevent drift • 60 channel selections • Programmable time on & off • 24 hour LED digital clock • Favorite channel memory & recall plus scan • Wireless hand held infra-red transmitter system • Automatic fine tune • Adaptable to any brand television • One year warranty service

\$139.95

CABLE TV ACCESSORIES

2 set coupler	2.95
3 set coupler	3.95
4 set coupler	4.50
F Connectors	25
Matching transformer	.99
TV Game Switch	3.95
VHF-UHF AMP-28DB	29.95

2-WAY SWITCH for

printers, modems, & computers (RS232)

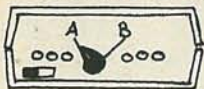

\$119.95

SGL WABER \$35.95

Protect your computer and electronic equipment from voltage spikes



WINEGARD FM CAR ANTENNA BOOSTER

Amplifies FM radio signals an average of 18dB (8 times). Improves car radio reception and extends range to allow greater selection of stations. Switch and indicator light attaches to lower edge of dash. 24" cable with Motorola plugs provided. Installs in minutes. Great for window antennas.

\$26.95

REFURBISHED MONITORS

9", 12", Commercial Grade as low as **\$49.95**



1500 Feet Cordless Phone \$229.95

10 KM (6 miles) Cordless Phone for Export Use Only \$325.00



BECKMAN CIRCUITMATE 20

8 functions and 30 ranges - Diode/transistor test function - auto-polarity, auto-zero, and auto-decimal - 10 Amps AC and DC Current Capability - Transistor Gain Test (hFE) - Conductance



\$64.95

Jerrold 36 Channel Remote CATV Converter

w/on/off Fine Tuning \$94.95
58 Channel Wireless \$109.95



40 Channel VHF to UHF Block Converter

28.95 Ea.
24.95 4 & up

Deluxe Version - Features fine tuning knob, matching X former & 2 cables \$38.95



Volume Discounts

Min. Order \$25.00			
International shipping Add'l.	to 75.00	\$2.50	
Prices subject to change	76.00 to 250.00	\$4.50	
without notice	251.00 to 500.00	\$6.00	
COD 2.00 Extra	501.00 to 750.00	\$8.50	
*Add'l. shipping for monitors	751.00 to 1000.00	\$12.00	
	Over 1000.00	\$12.50	

(516) 499-9500 Mon Th Tu W F Sa
9-8 9-6 9:30-5

ADVERTISING INDEX

RADIO-ELECTRONICS does not assume any responsibility for errors that may appear in the index below.

Free Information Number	Page	
62	Abex	103
3	Active Electronics	119
—	Advance Electronics	15,21
80	Advanced Computer Products	125
73	All Electronics	115
51	AMC Sales	130
56	AP Products	Cover IV
89	Arizona Electronic Surplus	110
60	BBC Metrawatt	9
41,78	Beckman Instruments	Cover III,38
67	Beta Electronics	116
42	B&K Precision Dynascan	23
35	Cambridge Learning	32
—	C&D Electronics	40
18	CEI	120
34	Chaney Electronics Inc.	130
—	CIE, Cleveland Institute of Electronics	34-37
44	Circuits Specialists	119
24,28,81	Communications Electronics	6,7,2
88	Components Express	124
68	Computer Products & Peripherals	134
69	Cooper Tools	Cover II
61	CRT Factory (Lakeside)	103
39	Digi-Key	122,123
11	Digitron	134
53	Direct Video Sales	99
99	Dokay Computer Products	117
—	Dynasty Electronics	103
45	Electronic Rainbow	22
6	Electronic Specialists	136
—	Electronic Technology Today	99,135
33	Electronic Warehouse	47
15	Enterprise Development	44
50	ETCO	132
10	Etronix	40
40	Firestick Antenna	32
—	Fordham Radio	39,41,43,45
76	Formula International	114
21	Gamma Electronics	124
84	Gilco International	134
—	Gladstone Electronics	99
31	Global Specialties	13
—	Grantham Schools	44
75	Hal-tronix	133
—	Handyman	42
7,16	Heath	68-71,11
85	Hickok Electrical Instrument	48
—	ICS Computer Training	46
94	Illinois Audio	44
20	Jameco Electronics	112,113
54	Jan Crystals	38
29	Javanco	119
49	JDR Microdevices	126-129
63	J&W Electronics	102
46	Kalglo Electronics	99
83	KCS Electronics	130
48	Kikisui	33
93	Mean Electronics	102
—	Memotech	24
66	MFJ Enterprises	42
17	Micro Management	118
—	Monarchy Engineering	120
—	Neonics R&D Ltd.	28
90	Network Sales	133
—	New Horizons	27,97
—	Newtone Electronics	31
—	NRI Schools	16-19
—	NTS Schools	86-89
—	OEM Distributing	102,103
37	Ora Electronics	25
58	Pacific 1	103
52	PAIA Electronics	40
—	Philips ECG	49
5	Pomona Electronics	29
30	Professional Video	132
—	Radio-Electronics Reprint Bookstore	28
86	Radio Shack	111
79	Ramsey Electronics	121
27	R.F. Electronics	133
32	Sams Books	31
—	Scientific Systems	132
25	SCR Electronics Center	118
55	SEI	124
70,71	Sencore	11
82	Sintec	26
23	Solid State Sales	118
59	Soltec	50
47	Spartan Electronics	136
72	Symmetric Sound Systems	102
38	Taft Electronics	101
8	Technical Electronics	130
74	Tektronix	5
65	Teletone	102
64	Traband Electronics	103
4,14	Triplett	30
95	Wersi	42
13	Westech	131
26	Wm. B. Allen Supply	132

Take stock in America.



PREVENT HI-TECH HEADACHES

Our Isolators eliminate equipment interaction,



clean up interference, curb damaging power line spikes and lightning bursts.

ISO-1 Isolator

3 isolated sockets; quality spike suppression; basic protection. . . \$76.95

ISO-3 Super-Isolator

3 dual isolated sockets; suppressor; commercial protection. \$115.95

ISO-17 Magnum Isolator

4 quad isolated sockets; suppressor; laboratory grade protection. . . \$200.95

ESP Electronic Specialists, Inc.

171 S. Main St., Box 389, Natick, MA 01760

Toll Free Order Desk 1-800-225-4876

MasterCard, VISA, American Express

CIRCLE 6 ON FREE INFORMATION CARD



The Workaholics.

Beckman DMMs stay on the job when others call it quits. They're a hard-nosed breed of 3½ digit hand-held multimeters you can always count on for outstanding performance.

Staying power

Beckman DMMs work up to 2000 hours on a common 9V battery. That's ten times longer than other DMMs. And to prevent burnout on the job, Beckman DMMs can withstand 1500 Vdc loads and 6kV transients. Current ranges are protected with a 2A/250V fuse, and resistance ranges are protected up to 500 Vdc.

Easy to work with

No matter how hard they work, they're never hard to work with. Their single rotary switch makes function and range selection simple and sure. For your added convenience, most Beckman DMMs have built-in 10-Amp capability and Insta-ohms® continuity indication. That means you never have to carry an accessory shunt or wait for a continuity check.

SELECTION CHART

MODEL	SPECIAL FEATURES	BASIC DC ACCURACY	INSTA-OHMS®	10 AMPS	SUGGESTED RETAIL PRICE (U.S.)
Tech 300	Basic six functions	0.5%			\$120
Tech 310	Added features	0.25%	✓	✓	145
Tech 310UL	UL-listed	0.25%	✓	✓	155
Tech 320B	Audible continuity beeper	0.1%	✓	✓	189
Tech 330	High accuracy & true RMS (AC & DC)	0.1%	✓	✓	219
HD-100	Heavy duty (drop-proof, contamination-proof)	0.25%	✓		169
HD-110	Heavy duty, plus 10 Amps	0.25%	✓	✓	189

And to make sure that the job is done right the first time, Beckman DMMs have superior RF shielding, and an impressive 22 Meg-ohm input impedance that reduces circuit loading to ensure accurate readings.

No matter how much the job demands, you can count on Beckman DMMs to see you through.

There's a Beckman DMM just right for every application. Use the selection chart to find the model best for you.

For a closer look at the workaholics, see your local Beckman distributor today. To locate the one nearest you, call or write Beckman Instruments, Inc., Instrumentation Operations, 210 S. Ranger Street, Brea, CA 92621. (714) 993-8803.

BECKMAN



Last night Mark Davis started over from scratch. Without wasting so much as a lead wire.

Some day Mark will be working on bigger projects. But right now, he's learning. Fortunately, the new ACE 109 solderless breadboard from A P PRODUCTS, just made learning a lot more affordable.



**ACE 109 SOLDERLESS BREADBOARD
PRICED UNDER \$20.***

* SUGGESTED U.S. RESALE PRICE

The ACE 109 is the newest, lowest priced All Circuit Evaluator in the A P PRODUCTS line. It has a universal matrix of 840 solderless plug-in tie-points. And is ideal for designing, testing and modifying small circuits. ACE 109 has three, standard 5-way binding posts for easy access to power sources.

With an ACE 109, there's no wiring, soldering or desoldering. Just plug in your components and interconnect them with ordinary solid hook-up wire. If you want to make a circuit change, just unplug the components involved and start over. It's just that easy.

Every ACE breadboard makes circuitry easy, fast, flexible. Now A P PRODUCTS has made it even more affordable. The ACE 109 is priced under \$20.*

Look for the complete line of ACE breadboards and other A P PRODUCTS at your favorite electronics distributor. For the name of the A P PRODUCTS distributor nearest you, call Toll-Free: (800) 321-9668.

(In Ohio, call collect (216) 354-2101.)

Make the A P connection.



A P PRODUCTS INCORPORATED • 9450 Pineneedle Drive • P. O. Box 540 • Mentor, Ohio 44060 • (216) 354-2101 • TWX: 810-425-2250
In Europe, contact A P PRODUCTS GmbH • Bäumlesweg 21 • D-7031 Weil 1 • West Germany

CIRCLE 56 ON FREE INFORMATION CARD